



CUPRA A T E C A

Owner's manual



Vehicle identification data

Model:
Vehicle Registration:
Vehicle identification number:
Date of vehicle registration or vehicle delivery:
SEAT Official Service:
Service advisor:
Telephone:

Confirmation of receipt of documentation and vehicle keys

The following items were delivered with the vehicle:	YES	NO
On-board documentation	<input type="checkbox"/>	<input type="checkbox"/>
First key	<input type="checkbox"/>	<input type="checkbox"/>
Second key	<input type="checkbox"/>	<input type="checkbox"/>
Correct working order of all keys was checked	<input type="checkbox"/>	<input type="checkbox"/>
Location:		
Date:		
Signature of owner:		

Introduction

Thank you for your trust choosing a CUPRA vehicle.

With your new CUPRA, you will be able to enjoy a vehicle with state-of-the-art technology and top quality features.

We recommend reading this Instruction Manual carefully to learn more about your vehicle so you can enjoy all its benefits in your daily driving.

Information about handling is complemented with instructions regarding the operation and maintenance of the vehicle in order to ensure its safety and maintain its value. Moreover, we want to give you valuable advice and tips to drive your vehicle efficiently and respecting the environment.

We wish you safe and enjoyable motoring.

CUPRA

WARNING

Read and always observe safety information concerning the passenger's front airbag >>> page 74, Important information regarding the front passenger's airbag.

About this manual

This manual describes the **features** of the vehicle at the time of drafting this text. Some of the features described below will be introduced in the future or will only be available in certain markets.

Some of the features described here are not included in all the types or variations of the model and they can be varied or modified based on technical or marketing requirements without it being considered misleading advertising.

Some details on the **drawings** may vary from its vehicle and must be interpreted as a standard representation.

The **direction indicators** (left, right, forwards, backwards) in this manual refer to the travel direction of the vehicle unless otherwise stated.

The **audiovisual material** is only meant to help the users better understand some features of the car. It is not a replacement for the instruction manual. Access the instruction manual to see the complete information and warnings.

★ The **features marked with an asterisk** are included by default only in certain versions of the model, supplied as optional only for certain versions or only offered in certain countries.

® **Trademarks** are marked with ®. The absence of this symbol does not guarantee that the term is not a trademark.

>> It indicates that the section continues on the next page.

⚠ Important warnings on the page.

📖 More in-depth content on the page.

📄 General information on page indicated.

SOS Emergency information on the page.

You can access the information in this manual using:

- Thematic table of contents that follows the manual's general chapter structure.
- Visual table of contents that uses graphics to indicate the pages containing "essential" information, which is detailed in the corresponding chapters.
- Alphabetical index with many terms and synonyms to help you find information.

⚠ WARNING

Texts after this symbol contain information about safety and warn you about possible accident or injury risks.

ⓘ CAUTION

Texts after this symbol indicate possible damage to the vehicle.

♻ For the sake of the environment

Texts after this symbol contain information about the protection of the environment.

ℹ Note

Texts after this symbol contain additional information.

Printed Instruction Manual

The printed instruction manual contains relevant information about the use of the vehicle and the Infotainment System.

The digital version of the manuals contains more in-depth information.

Frequently Asked Questions

Before driving

How do you adjust the seat? »» page 19

How do you adjust the steering wheel?
»» page 21

How do you adjust the exterior mirrors?
»» page 20

How do you turn on the exterior lights?
»» page 30

How does the automatic gearbox selector lever work? »» page 38

How do you refuel? »» page 41

How do you activate the windscreen wipers and windscreen washer system? »» page 32

Emergency situations

A warning lamp lights up or flashes. What does this mean? »» page 36

How do you open the bonnet? »» page 17

How do you perform a jump start? »» page 52

Where is the vehicle tool kit located?
»» page 48

How do you repair a tyre with the anti-puncture kit? »» page 47

How do you change a wheel? »» page 48

How do you change a fuse? »» page 45

How do you change a light? »» page 46

How do you tow a vehicle? »» page 51

Useful tips

How do you set the time? »» page 104

When should the vehicle inspection should be performed? »» page 106

What functions do the buttons/thumbwheels on the steering wheel perform? »» page 110

How do you remove the luggage compartment cover? »» page 155

How do you drive in an economical and environmentally-friendly way? »» page 233

How do you check and top up the engine oil?
»» page 41

How do you check and top up the engine coolant? »» page 42

How do you top up the windscreen washer fluid?
»» page 43

How do you check and top up the brake fluid?
»» page 43

How do you check and adjust tyre pressure values? »» page 322

Vehicle washing tips »» page 334

Functions of interest

Easy Connect, Car menu »» page 33

How does the START-STOP system work?
»» page 238

What parking assistants are available?
»» page 281

How does the rear assist work? »» page 294

How does the adaptive cruise control work?
»» page 251

How can the driving mode be adjusted?
»» page 271

How does the lane departure warning system work? »» page 260

How does tyre pressure monitoring work?
»» page 325

How do you open the vehicle without a key (Keyless Access)? »» page 116

Interior lighting and ambient light »» page 138

Table of Contents

The essentials	7	Emergency towing of the vehicle	51	Instruments and warning/control lamps	94
Exterior view	7	How to jump start	52	Dashboard	94
Exterior view	8	Changing the wiper blades	54	Using the instrument panel	108
Driver-side general instrument panel (left-hand drive)	9	Safety	56	Control lamps	109
Driver-side general instrument panel (right-hand drive)	10	Safe driving	56	Multifunction steering wheel	110
Passenger-side general instrument panel (left-hand drive)	11	Safety first!	56	Opening and closing	112
Passenger-side general instrument panel (right-hand drive)	12	Advice about driving	56	Central locking	112
Centre console	13	Correct position of the vehicle occupants	57	Anti-theft alarm system*	121
Interior view	14	Pedal area	61	Rear lid (luggage compartment)	124
How it works	15	Seat belts	62	Controls for the windows	126
Unlocking and locking	15	Why wear a seat belt	62	Sunroof*	128
Before driving	19	How to properly adjust your seat belt	65	Lights and visibility	132
Airbags	21	Seat belt tensioners	66	Lights	132
Child seats	24	Airbag system	68	Visibility	139
Starting the vehicle	30	Brief introduction	68	Windscreen wiper and window wiper systems	139
Lights and visibility	30	Airbag safety instructions	70	Mirror	142
Easy Connect	33	Deactivating airbags	72	Seats and head restraints	143
Warning lamps	36	Transporting children safely	73	Adjusting the seats and headrests	143
Cruise control	37	Safety for children	73	Seat functions	145
Gearbox	38	Child seats	75	Transport and practical equipment	147
Air conditioning	39	Emergencies	78	Storage compartments	147
Fluid level control	41	Self-help	78	Storing objects	150
Emergencies	45	Vehicle tool kit, anti-puncture kit*	78	Roof carrier*	156
Fuses	45	Tyre repair	78	Air conditioning	158
Bulbs	46	Manual unlocking/locking	80	Heating, ventilation and cooling	158
Action in the event of a puncture	46	Changing the windscreen wiper blades	81	Infotainment System	164
Changing a wheel	48	Tow-starting and towing	81	Introduction	164
Snow chains	50	Fuses and bulbs	85	Safety instructions related to the Infotainment system	164
		Fuses	85	Overview of the unit	166
		Changing a bulb	89	General instructions for use	167
		Operation	93	Connectivity	172
		Controls and displays	93	Data transfer	172
		General instrument panel	92	Full Link*	172

Table of Contents

Media Control*	179	Traffic Jam Assist	263	Maintenance	331
WLAN access point*	180	Emergency Assist	264	Maintenance Programme	331
Operating modes	182	Blind spot detector (BSD) with parking assistance (RCTA)*	265	Service intervals	331
Radio	182	Drive Profile*	271	Additional service offers	333
Media	184	Park Assist*	273	Warranty	334
Navigation	193	Parking aid parking and manoeuvring (ParkPi-lot)	281	Vehicle maintenance	334
Navigation in Offroad mode*	202	Parking System Plus*	283	Maintenance and cleaning	334
Vehicle Menu	205	Rear parking aid*	287	Remove the vehicle from traffic	339
Telephone	206	Top View Camera*	289	Information for the user	340
Multimedia	212	Rear Assist (Rear View Camera)*	294	Event Data Recorder	340
USB/AUX-INPort	212	Towing bracket device*	296	Description and operation	340
Connectivity Box* / Wireless Charger*	212	Trailer mode	296	Information about the EU Directive 2014/53/EU	341
Driving	214	Practical tips	307	Simplified EU compliance declaration	341
Start and driving	214	Care and maintenance	307	Table of correspondences	341
Starting and stopping the engine	214	Accessories and modifications to the vehicle	307	Addresses of the manufacturers	342
Braking and parking	217	Checking and refilling levels	308	Frequency bands, station power	342
Braking and stability systems	221	Filling the tank	308	Technical data	344
DSG automatic gearbox	224	Fuel	309	Technical specifications	344
Address	231	Engine compartment	310	Important	344
Run-in and economical driving	232	Engine oil	313	Vehicle identification data	344
Power management	234	Cooling system	316	Information on fuel consumption	344
Engine management and emission control system	235	Brake fluid	317	Trailer mode	345
Driving tips	236	Windscreen washer reservoir	318	Wheels	345
Driver assistance systems	238	Battery	318	Engine data	347
Start-Stop system	238	Wheels	321	Dimensions	348
Hill Descent Control (HDC)	240	Wheels and tyres	321	Index	351
Auto Hold Function	241	Tyre monitoring system	325		
Cruise control system (CCS)*	242	Temporary spare wheel	328		
Speed limiter	243	Winter service	329		
Emergency braking assistance system (Front Assist)*	247				
Adaptive cruise control (ACC)*	251				
Lane Assist system*	260				

Exterior view

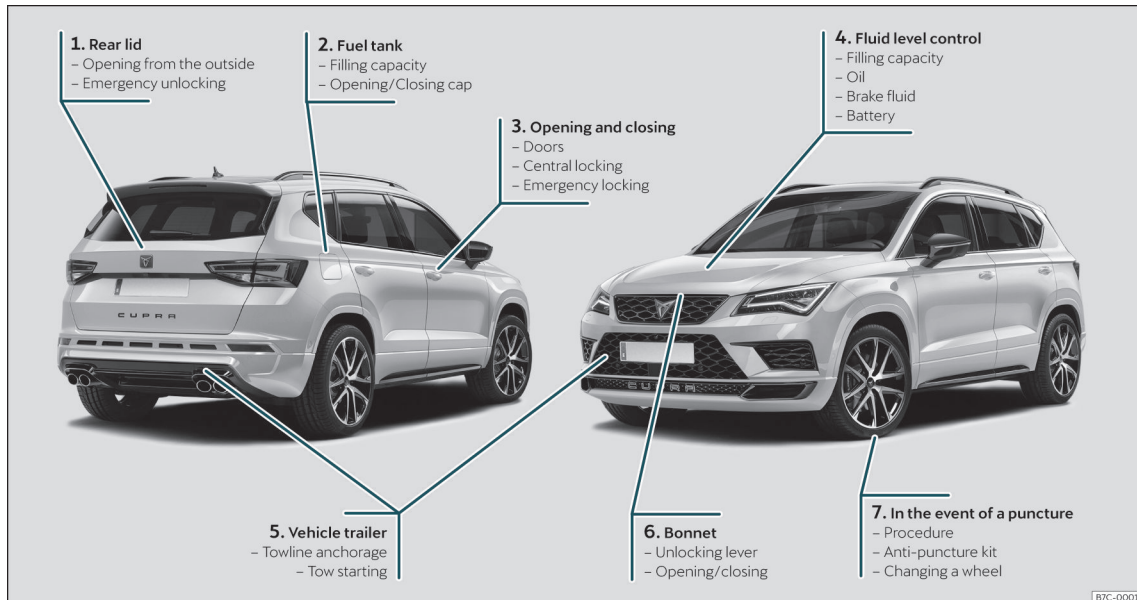

① >>> page 16

② >>> page 41

③ >>> page 15

④ >>> page 41

⑤ >>> page 51

⑥ >>> page 17

⑦ >>> page 46

Exterior view

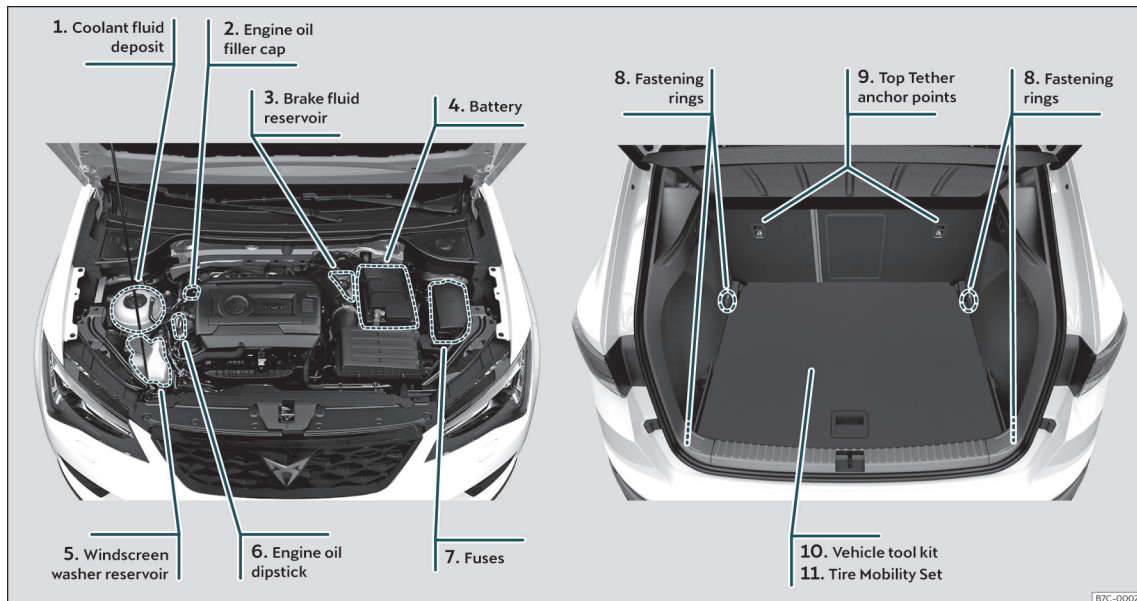

B7C-0002

① >>> page 42

② >>> page 41

③ >>> page 43

④ >>> page 44

⑤ >>> page 43

⑥ >>> page 41

⑦ >>> page 45

⑧ >>>  page 153

⑨ >>> page 29

⑩ >>> page 48

⑪ >>> page 47

Driver-side general instrument panel (left-hand drive)

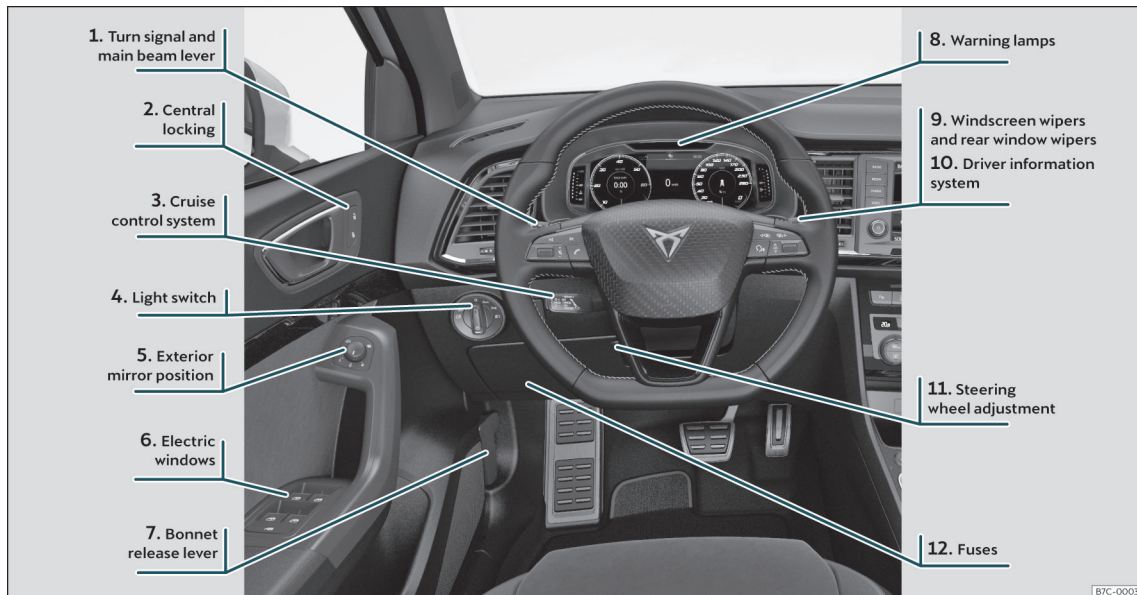

- ① >>> page 31
- ② >>> page 15
- ③ >>> page 37
- ④ >>> page 30

- ⑤ >>> page 20
- ⑥ >>> page 18
- ⑦ >>> page 17
- ⑧ >>> page 36

- ⑨ >>> page 32
- ⑩ >>>  page 99
- ⑪ >>> page 21
- ⑫ >>> page 45

B7C-0003

Driver-side general instrument panel (right-hand drive)

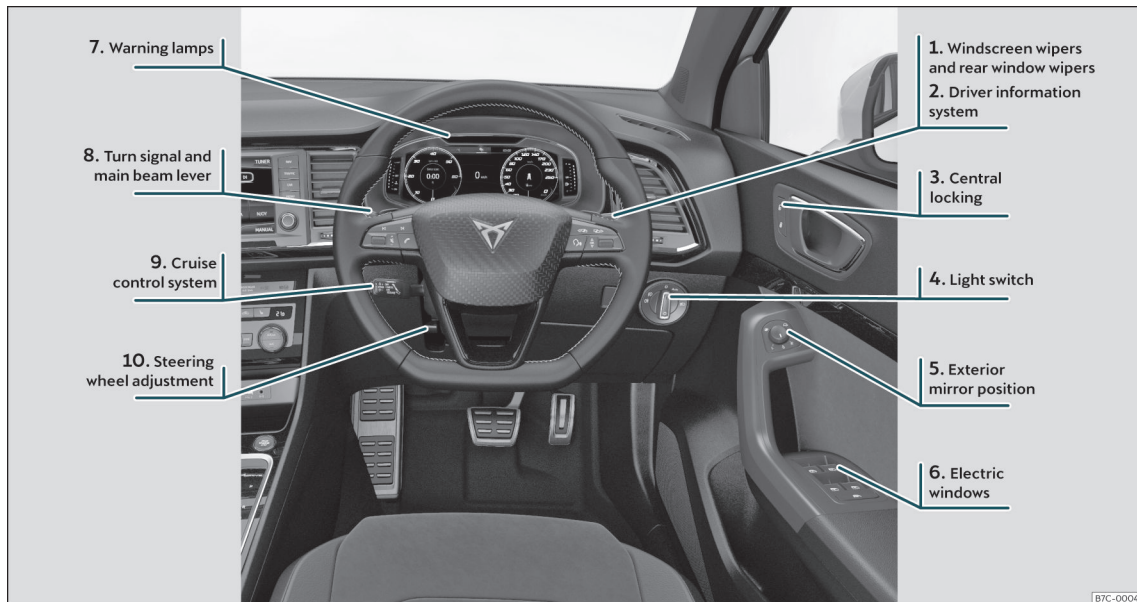

B7C-0004

① >>> page 32

② >>>  page 99

③ >>> page 15

④ >>> page 30

⑤ >>> page 20

⑥ >>> page 18

⑦ >>> page 36

⑧ >>> page 31

⑨ >>> page 37

⑩ >>> page 21

Passenger-side general instrument panel (left-hand drive)

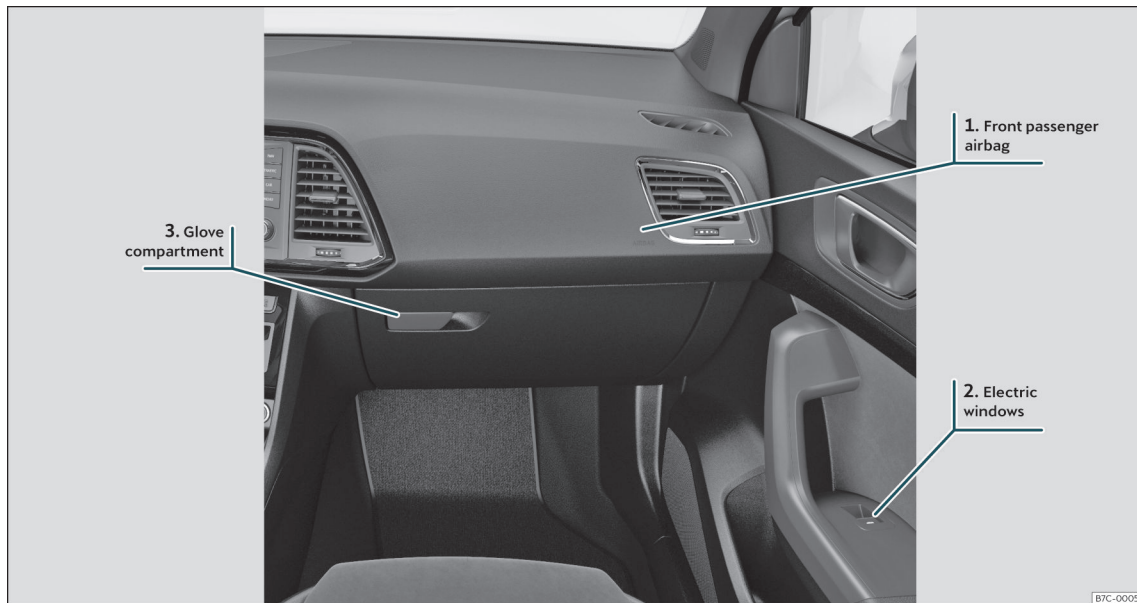

① >>> page 21

② >>> page 18

③ >>>  page 148

Passenger-side general instrument panel (right-hand drive)

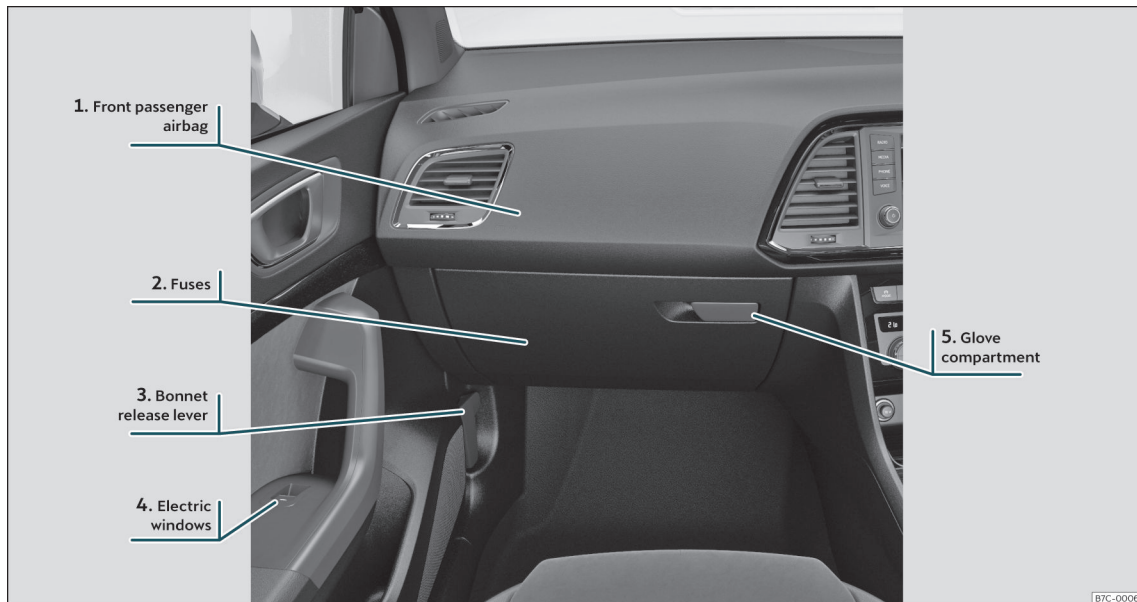

① >>> page 21

② >>> page 45

③ >>> page 17

④ >>> page 18

⑤ >>>  page 148

Centre console

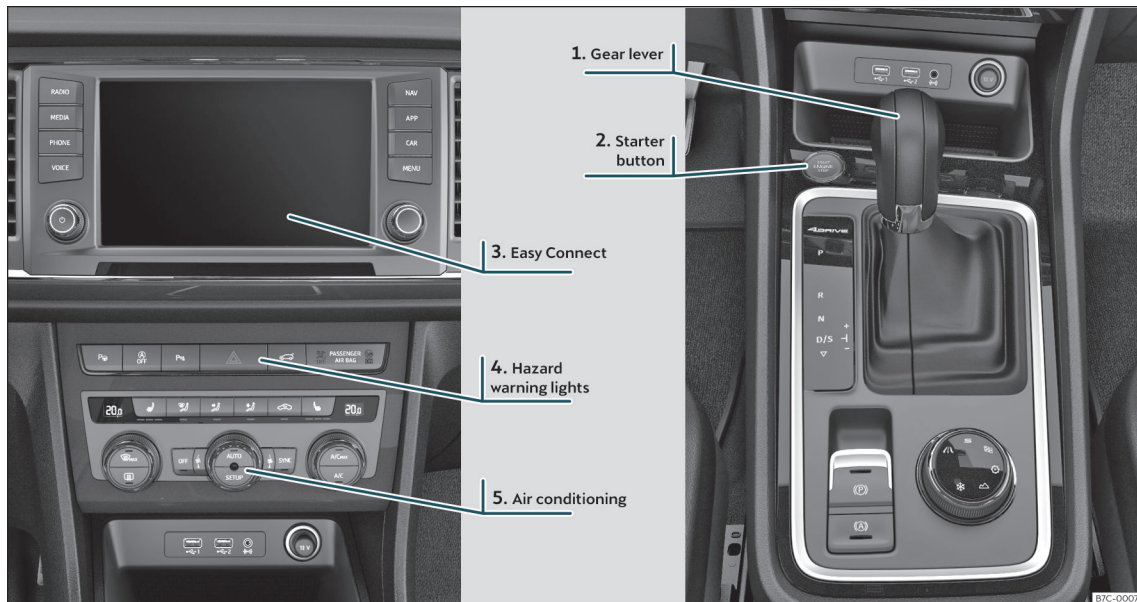

① >>> page 38

② >>>  page 214

③ >>> page 33, >>>  page 164

④ >>> page 31

⑤ >>> page 39

The layout in right-hand drive vehicles is symmetrical.

Interior view

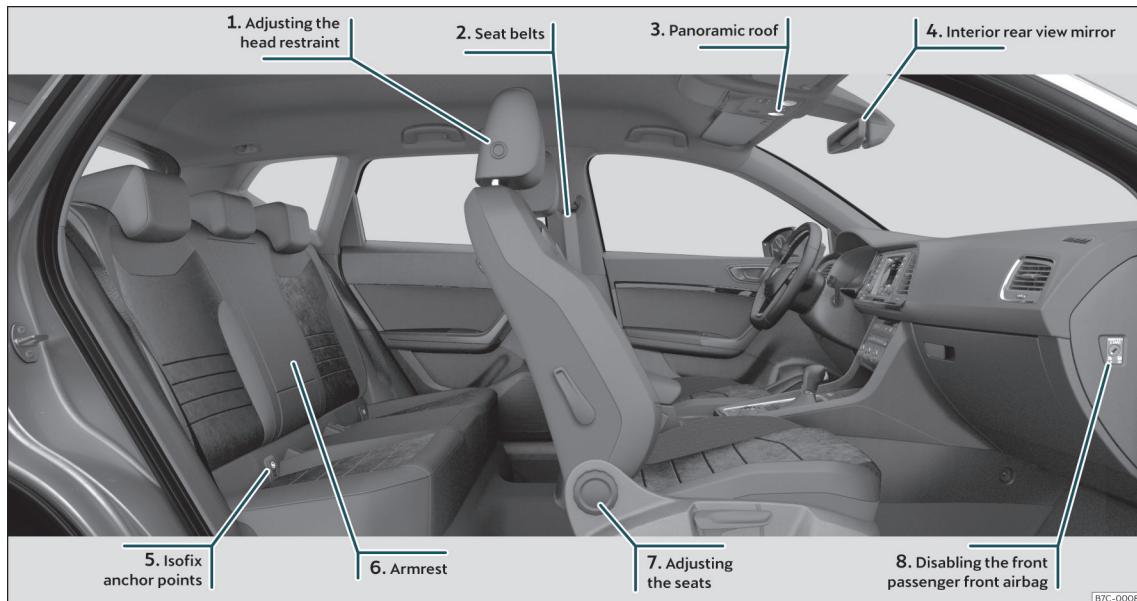

① >>> page 19

② >>> page 20

③ >>> page 18

④ >>>  page 142

⑤ >>> page 26

⑥ >>>  page 152

⑦ >>> page 19

⑧ >>> page 22

How it works

Unlocking and locking

Doors

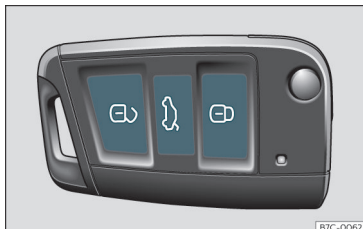





Fig. 1 Remote control key: keys.





Fig. 2 Driver door: central locking switch.

Locking and unlocking the vehicle using the key

- Locking: press the button  >>> Fig. 1.
- Locking the vehicle without activating the anti-theft system: Press the button for a second time  >>> Fig. 1 within 2 seconds.
- Unlocking: press the button  >>> Fig. 1.
- Unlock the trunk lid: hold down the  >>> Fig. 1 button for at least 1 second.

Locking and unlocking with the central locking switch

- Locking: press the button  >>> Fig. 2. None of the doors can be opened from the outside. The doors can be opened from the inside by pulling the inside door handle.
- Unlocking: press the button  >>> Fig. 2.



>>>  in Description on page 112



>>> page 112

SOS

>>> page 15, >>> page 16

Unlocking or locking of driver door

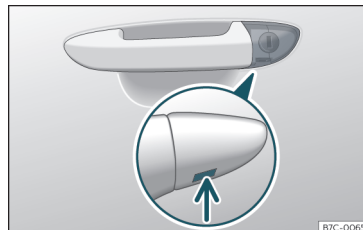





Fig. 3 Driver door lever: hidden lock cylinder.

If the central locking system should fail to operate, the driver door can still be locked and unlocked by turning the key in the lock.

As a general rule, when the driver door is locked manually all other doors are locked. When it is unlocked manually, only the driver door opens. Please observe the instructions relating to the anti-theft alarm system >>>  page 112.

- Unfold the vehicle key blade >>>  page 113.
- Insert the key shaft into the lower opening in the cover on the driver door handle >>> Fig. 3 (arrow) then remove the cover upwards.
- Insert the key blade into the lock cylinder to unlock or lock the vehicle. »

Special characteristics

- The anti-theft alarm will remain active when vehicles are unlocked. However, the alarm will not be triggered >>>  page 112.
- After the driver door is opened, you have 15 seconds to switch on the ignition. Once this time has elapsed, the alarm is triggered.
- Switch the ignition on. The electronic immobilizer recognises a valid vehicle key and deactivates the anti-theft alarm system.

Note

The anti-theft alarm is not activated when the vehicle is locked manually using the key shaft >>>  page 112.

Emergency locking of doors without door cylinder



Fig. 4 Locking the door manually.

If the central locking system should fail to work at any time, doors with no lock cylinder will have to be locked separately.

A mechanical locking device (only visible when the door is open) is provided on the front passenger door.

- Pull the cap out of the opening.
- Insert the key in the inside slot and turn it to the right as far as it will go (if the door is on the right side) or to the left (if the door is on the left side).

Once the door has been closed it can no longer be opened from the outside. Pull the interior door handle once to unlock and open the door.

Rear lid

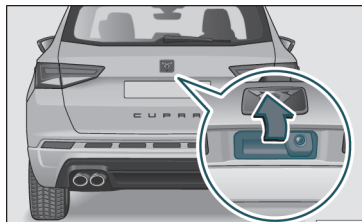

Fig. 5 Rear lid: handle

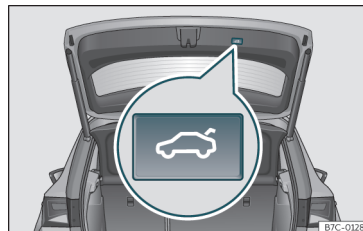



Fig. 6 Rear lid: button to close rear lid.

The rear lid opening system operates electrically*. It is activated by exerting slight pressure on the handle >>> **Fig. 5**.

To lock/unlock, press the button  or button  >>> **Fig. 1** on the remote control key.

A warning appears on the instrument panel display if the rear lid is open or not properly closed.* An audible warning is also given if it is opened while the vehicle is moving faster than 6 km/h (4 mph)*.

Opening and closing

- Open the rear lid: exert slight pressure on the handle. The rear lid opens automatically.
- Closing the rear lid: hold one of the handles on the inner trim and close it by sliding down, or press the button on the rear lid* >>> **Fig. 6**.

⚠ in Rear lid automatic locking on page 126

📖 » page 124

SOS » page 17

Manual release mechanism for the rear lid

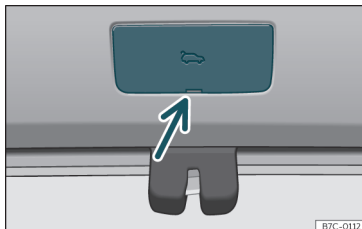

Fig. 7 Luggage compartment: access to manual release.

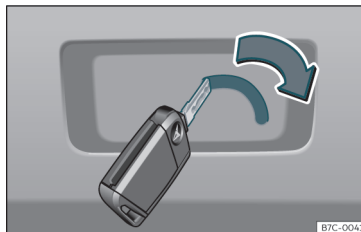

Fig. 8 Luggage compartment: manual release.

The rear lid can be unlocked manually from inside in the event of an emergency.

- Remove the cover using the key blade as a lever » **Fig. 7**.
- To unlock the rear lid, push the lever in the direction of the arrow using the key blade » **Fig. 8**.

Bonnet

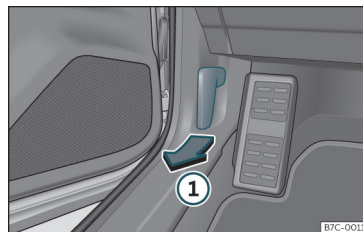

Fig. 9 Release lever in the driver's footwell area.

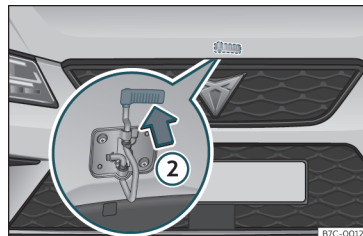

Fig. 10 Cam under the bonnet

Opening the bonnet

The bonnet is released from inside the vehicle.

Before opening the bonnet, make sure that the windscreen wiper arms are in place against the windscreen. »

- Open the door and pull the lever under the dashboard >>> Fig. 9 ①.
- To lift the bonnet: press the release catch under the bonnet upwards >>> Fig. 10 ②. The arrester hook under the bonnet is released.
- The bonnet can be opened. Release the bonnet stay and secure it in the fixture designed for this in the bonnet.

Closing the bonnet

- Slightly lift the bonnet.
- Release the bonnet stay and replace it in its support.
- At a height of approximately 30 cm let it fall so it locks.

If the bonnet does not close, do not press downwards. Open it again and let it fall as mentioned above.



>>> ⚠ in Opening and closing the bonnet on page 311



>>> page 310

Controls for the windows*

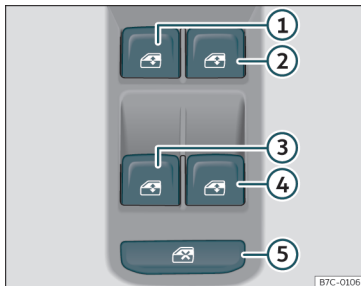



Fig. 11 Detail of the driver door: controls for the windows.

- Opening the window: press the button .
- Closing the window: pull the button .

Buttons on the driver door

- ① Window on the front left door
- ② Window on the front right door
- ③ Window on the rear left door
- ④ Window on the rear right door
- ⑤ Safety switch for deactivating the electric window buttons in the rear doors.



>>> ⚠ in Opening and closing the electric windows on page 127



>>> page 126

Panoramic roof*

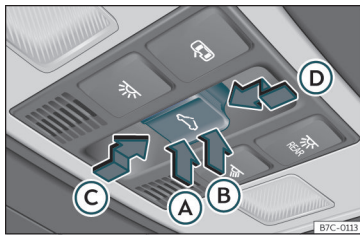

Fig. 12 On the interior roof lining: sunroof button.

- Open: press button **C** backwards.
- Close: press button **D** forwards.
- Raise: press the rear part of button **B**.
- Lower: press the front part of button **A**.



>>> ⚠ in Introduction on page 128



>>> page 128

Before driving

Manually adjusting the front seats

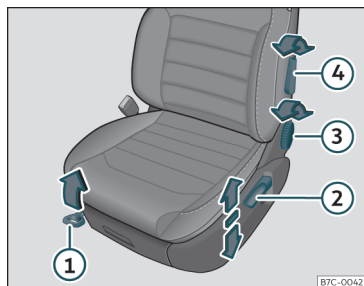

Fig. 13 Front seats: manual seat adjustment.

- ① Forwards/backwards: pull the lever and move the seat.
- ② Raising/lowering: pull/push the lever.
- ③ Tilting the backrest: turn the hand wheel.
- ④ Lumbar support: move the lever until the required position is achieved.



»» » ⚠ in Manual adjustment of the seats on page 143

Electric adjustment of the driver's seat*

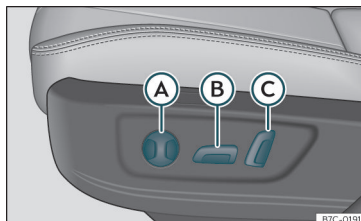

Fig. 14 Driver's seat: electric seat adjustment.

- A Adjust the lumbar support: press the button according to the desired position.
- B Seat forwards/backwards: press the button forwards/backwards.

Seat up/down: Press the rear part of the button up/down. To adjust the angle of the seat cushion, press the front of the button up/down.

- C Backrest further upright/further reclined: press the button forwards/backwards.



»» » ⚠ in Electric driver's seat adjustment* on page 144

Adjusting the head restraints

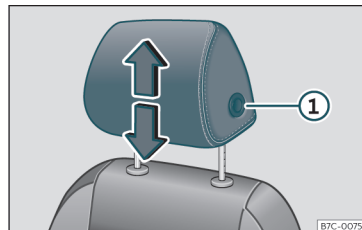

Fig. 15 Front seat: adjusting the head restraint.

- Grab the sides of the head restraints with both hands and push upwards to the desired position. To lower it, repeat the same action, pressing the ① button on the side.



»» » ⚠ in Correct adjustment of front head restraints on page 60



»» » page 60, »» » page 144

Adjustment of the seat belt

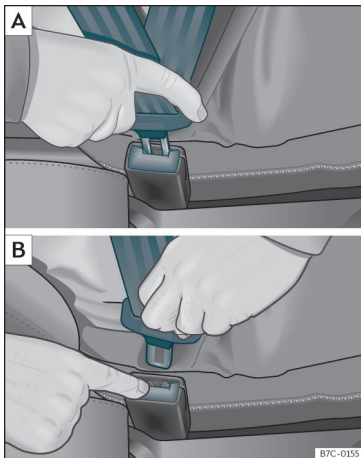

Fig. 16 Positioning and removing the seat belt buckle.

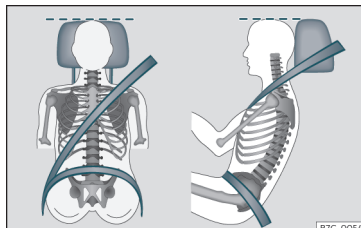

Fig. 17 Correct seat belt and head restraint positions, viewed from front and the side.

To adjust the seat belt around your shoulders, adjust the height of the seats.

The shoulder part of the seat belt should be well centred over it, never over the neck. The seat belt lies flat and fits comfortably on the upper part of the body.

The lap part of the seat belt lies across the pelvis, never across the stomach. The seat belt lies flat and fits comfortably on the pelvis.



>>> page 63



>>> page 65

Seat belt tensioners

During a collision, the seat belts on the front seats and side rear seats¹⁾ tighten automatically.

The tensioner can be triggered only once.



>>> ⚠ in Maintenance and disposal of belt tensioners on page 67



>>> page 66

Adjusting the exterior mirrors

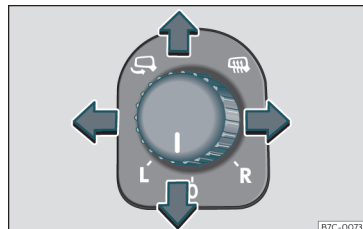

Fig. 18 Detail of the driver door: control for the exterior mirror.

Adjusting the exterior mirrors: Turn the knob to the corresponding position:

¹⁾ Depending on version/market.

L/R Turning the knob to the desired position, adjust the mirrors on the driver side (L, left) and the passenger side (R, right) to the direction desired.

Depending on the equipment fitted on the vehicle, the mirrors may be heated according to the outside temperature.

Folding in mirrors.



>>> ⚠ in Adjusting the exterior rear-view mirrors on page 143



>>> page 142

Adjusting the steering wheel

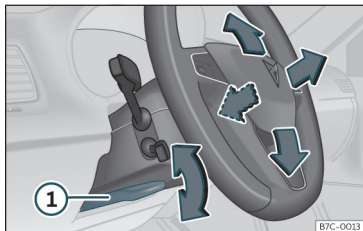

Fig. 19 Lever in the lower left side of the steering column.

• Adjusting the position of the steering wheel: pull the >>> **Fig. 19** ① lever down,

move the steering wheel to the desired position and lift the lever back up until it locks.



>>> ⚠ in Adjusting the steering wheel position on page 58

Airbags

Front airbags

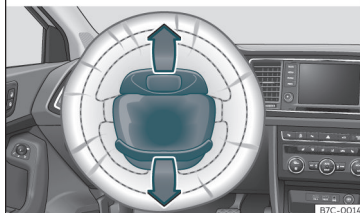

Fig. 20 Driver airbag located in steering wheel.



Fig. 21 Front passenger airbag located in dash panel.

The front airbag for the driver is located in the steering wheel >>> **Fig. 20** and the airbag for the front passenger is located in the dash panel >>> **Fig. 21**. Airbags are identified by the word "AIRBAG".

When the driver and front passenger airbags are deployed, the covers remain attached to the steering wheel and dashboard, respectively >>> **Fig. 20** >>> **Fig. 21**.

In conjunction with the seat belts, the front airbag system gives the front occupants additional protection for the head and chest in »

the event of a severe frontal collision >>>  in Front airbags on page 70.

Their special design allows the controlled escape of the propellant gas when an occupant puts pressure on the bag. Thus, the head and chest are protected by the airbag. After the collision, the airbag deflates sufficiently to allow visibility.



>>> page 70

Deactivating the front passenger front airbag





Fig. 22 Front passenger front airbag switch.



Fig. 23 Dashboard: control lamp for deactivated front passenger airbag in centre console.

To deactivate the front passenger front airbag:

- Switch the ignition off.
- Open the door on the front passenger side.
- Insert the key into the slot of the switch for deactivating the front passenger airbag >>> Fig. 22. About 3/4 of the key should enter; this is as far as it will go.
- Turn the key gently to the **OFF** position. If you have difficulty, ensure that you have inserted the key as far as it will go.
- Close the front passenger door.
- Check, with the ignition switched on, that the **OFF**  control lamp remains lit where it says **PASSENGER AIR BAG OFF** ; in the centre of the dash panel >>> Fig. 23.



>>>  in Activation and deactivation of front passenger airbag on page 72



>>> page 72

Knee airbag*



Fig. 24 On the driver side: location of airbag for knees.

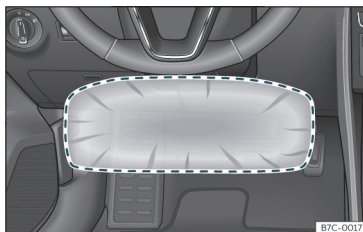

Fig. 25 On the driver side: action radius of airbag for knees.

The knee airbag is located on the driver side below the dash panel >>> **Fig. 24**. Airbags are identified by the word "AIRBAG".

The area framed in red (deployment area) >>> **Fig. 25** is covered by the knee airbag when

it is deployed. Objects should never be placed or mounted in this area.



>>> page 70

Side airbags

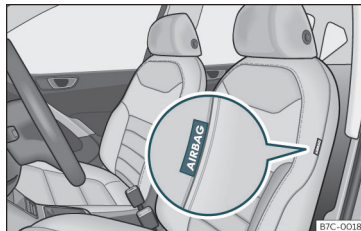

Fig. 26 Side airbag in driver's seat.

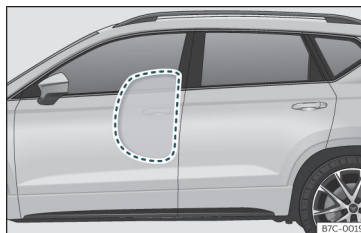



Fig. 27 Illustration of completely inflated side airbags on the left side of the vehicle.

The side airbags are located in the driver's seat and front passenger seat backrests >>> **Fig. 26**. The locations are identified by the text "AIRBAG" in the upper region of the backrests.

In conjunction with the seat belts, the side airbag system provides additional protection for the upper body in the event of a severe side collision >>>  in Side airbags on page 70.

In a side collision, the side airbags reduce the risk of injury to passengers to the areas of the body facing the impact. In addition to their normal protection, the seat belts also hold the passengers in the event of a side collision; this is how these airbags provide maximum protection.



>>> page 70

Head-protection airbags*

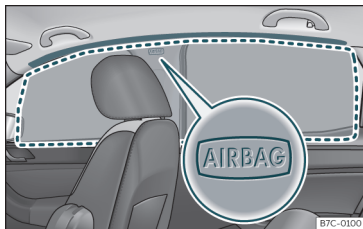



Fig. 28 Location of head-protection airbags.

The head-protection airbags are located on both sides in the interior above the doors »» Fig. 28 and are identified with the text "AIRBAG".

In conjunction with the seat belts, the head-protection airbag system gives the vehicle occupants additional protection for the head and upper body in the event of a severe side collision »»  in Curtain airbags* on page 71.



»»  in Curtain airbags* on page 71

Child seats

Important information regarding the front passenger's airbag

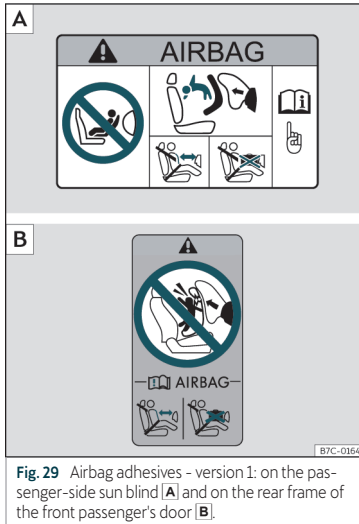

Fig. 29 Airbag adhesives - version 1: on the passenger-side sun blind [A] and on the rear frame of the front passenger's door [B].

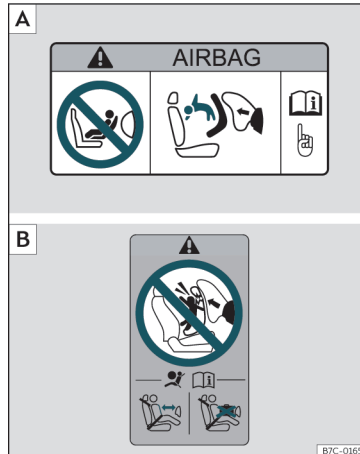



Fig. 30 Airbag adhesives - version 2: on the passenger-side sun blind [A] and on the rear frame of the front passenger's door [B].

A sticker with important information about the passenger airbag is located on the passenger's sun visor and/or on the passenger side door frame.



»»  in Important information regarding the front passenger's airbag on page 74



»» page 73

Securing child seats

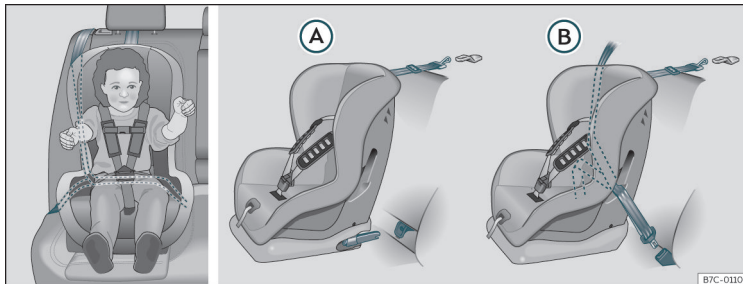

Fig. 31 On rear seats: possible assemblies of children seats.

Figure » **Fig. 31 A** shows the basic child restraint system mounting using lower retaining rings and the upper retaining strap. Figure » **Fig. 31 B** shows the child restraint system mounting using the vehicle seat belt.

The seat belt may be used to secure **universal** type child seats to the vehicle seats marked with a **U** in the table below.

- *In the passenger seat without height regulation:* the passenger seat must be in its rear-most position¹⁾.

- *In the passenger seat with height regulation:* the passenger seat must be in its rear-most and highest position¹⁾.

To correctly use a child seat in the back, the front backrest must be adjusted so that there is no contact with the child seat in the back in the case that it goes opposite to the direction of the car. In the case of front facing restraint systems, the front backrest must be adjusted so that there is no contact with the child's feet.

To adjust the passenger seat to accommodate a child's seat and get the seat belt in a

perfect position, adjust the passenger backrest as far forward as possible¹⁾.

If a semi-universal type chair is to be installed, in which the method of attachment to the car is through the seat belt and support bracket, it should never be installed in the central rear seat as the ground clearance is lower than in other places and the support bracket will not allow the seat to remain sufficiently stable.

The systems include the child restraint system mounting with an upper retaining »

¹⁾ Compliance with current national legislation and the manufacturer's instructions is required when using or installing child seats.

strap (Top Tether) and lower anchoring points on the seat.

Weight group	Seating position			
	Front passenger seat ^{a)}		Rear side seat	Rear central seat ^{b)}
	airbag on	airbag off		
Group 0 to 10 kg	X	U ^{c)}	U	U
Group 0+ to 13 kg	X	U ^{c)}	U	U
Group I 9 to 18 kg	X	U ^{c)}	U	U
Group II 15 to 25 kg	X	UF ^{c)}	UF	UF
Group III 22 to 36 kg	X	UF ^{c)}	UF	UF

X: It is not compatible to install chairs in this configuration.

U: Suitable for universal restraint systems for use in this weight group.

UF: Acceptable for front-facing universal-category child restraint systems approved for this mass group.

- a) Compliance with current national legislation and the manufacturer's instructions is required when using or installing child seats.
- b) For semi-universal chairs where the securing system is the car safety belt and the support bracket, do not use them in the centre rear seat.
- c) Seats **without** height adjustment should be placed in their rearmost position. Seats **with** height adjustment should be placed in their rearmost and highest position.



»» » in Safety instructions on page 75

Securing child seats with "ISOFIX" and Top Tether*

Child seats can be secured quickly, easily and safely on the rear outer seats with the "ISOFIX" and Top Tether* system.

Two "ISOFIX" retaining rings are fitted on each rear seat. In some vehicles, the rings are secured to the seat frame and, in others, they are secured to the rear floor. The "ISO-

FIX" rings are located between the rear seat backrest and the seat cushioning »» » Fig. 32. The Top Tether* rings are located on the rear

part of the backrests of the rear seats (behind the seat backrest or in the boot) »» Fig. 34.

To understand the compatibility of the "ISO-FIX" systems in the vehicle, consult the table below.

The body weight permitted and information regarding sizes A to F is indicated on the label on child seats with "universal" or "semi-universal" certification.

Weight group	Size class	Electrical equipment	Vehicle Isofix positions			
			Front passenger seat		Rear side seat	Rear central seat
			airbag on	airbag off		
Baby carrier	F	ISO/L1	X	X	X	X
	G	ISO/L2	X	X	X	X
Group 0 to 10 kg	E	ISO/R1	X	X	IL	X
Group 0+ to 13 kg	E	ISO/R1	X	X	IL	X
	D	ISO/R2	X	X	IL	X
	C	ISO/R3	X	X	IL	X
Group I 9 to 18 kg	D	ISO/R2	X	X	IL	X
	C	ISO/R3	X	X	IL	X
	B	ISO/F2	X	X	IUF/IL	X
	B1	ISO/F2X	X	X	IUF/IL	X
	A	ISO/F3	X	X	IUF/IL	X
Group II 15 to 25 kg	---	---			---	---
Group III 22 to 36 kg	---	---			---	---

IUF: Suitable for forward-facing ISOFIX universal child restraint systems approved for use in this mass group.

IL: Suitable for certain ISOFIX child restraint systems (CRSs) listed in the attached list. This relates to ISOFIX CRSs that can be for the specific vehicle, restricted or semi-universal categories.

X: ISOFIX position not suitable for ISOFIX child restraint systems for this weight group or size class.



»» » ⚠ in Safety instructions on page 75

Securing child seats with the “ISOFIX/i-Size”



Fig. 32 ISOFIX/i-Size securing rings.

You are obliged to follow the seat manufacturer's instructions.

• Press the child seat onto the “ISOFIX” retaining rings »» Fig. 32 until the child seat is heard to engage securely. If the child seat is equipped with Top Tether* anchor points, secure it to the correspondent ring »» Fig. 34. Observe the manufacturer's instructions.

• Pull on both sides of the child seat to ensure that it is properly anchored.

Child seats with the “ISOFIX” and Top Tether* attachment system are available from Technical Services.

	Vehicle i-Size positions			
	Front passenger seat		Rear side seat	Rear central seat
	airbag on	airbag off		
Child restraint system approved under ECE R129	X	X	i-U	X

i-U: Valid position for front-facing and rear-facing child restraint systems approved under ECE R129.

X: Invalid position for child restraint systems approved under ECE R129.

Securing child seats with the Top Tether* retaining straps

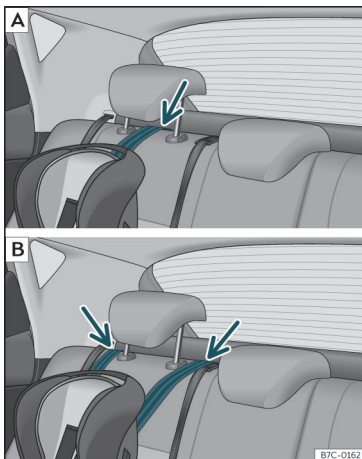

Fig. 33 Retainer strap: adjustment and assembly according to the Top Tether belt.



Fig. 34 Position of the Top Tether rings on the back of the rear seat.

Child seats with the Top Tether system come with a strap for securing the seat to the vehicle anchor point, located at the back of the rear seat backrest and provide greater restraint.

The objective of this strap is to reduce forward movements of the child seat in a crash, to reduce the risk of injuries to the head from hitting the inside of the vehicle.

Using the Top Tether in rear-facing mounted seats

Currently, there are very few rear-facing child safety seats that have Top Tether. Please carefully read and follow the seat manufacturer instructions to learn the proper way to install the Top Tether strap.

Securing the retainer strap

- Follow the manufacturer's instructions to deploy the child seat Top Tether retainer strap.
- Place the belt under the head restraint of the back seat >>> **Fig. 33** (depending on the instructions of the chair itself, lift or remove the head restraint if necessary).
- Slide the strap and secure it properly with the anchorage of the backrest >>> **Fig. 34**.
- Firmly tighten the strap following the manufacturer's instructions.

Releasing the retaining strap

- Loosen the strap following the manufacturer's instructions.
- Push the lock and release it from the anchoring support.



>>> ⚠ in Safety instructions on page 75

Starting the vehicle

Starter button



Fig. 35 In the lower part of the centre console: start button.

The vehicle engine is started with a starter button (Press & Drive). To do so, there must be a valid key inside the vehicle in the area of the front or rear seats.

In vehicles with the Keyless Access >>> page 112 system, the engine can also be started with the key in the luggage compartment.

Opening the driver's door **when exiting the vehicle** activates the electronic lock on the steering column if the ignition is disabled.

Start the engine (Press & Drive)

1. Press and hold the brake pedal until step 5 is performed.

2. Move the selector lever to the **P** or **N** position.

Briefly press the starter button >>> **Fig. 194** without pressing the accelerator. For the engine to start there must be a valid key in the vehicle.

After starting the engine, the light of the **(START ENGINE STOP)** button changes to a fixed light indicating that the engine has started.

3. If the engine does not start, stop and wait for approx. 1 minute before trying again. If necessary, carry out an emergency start >>> page 214.

4. Disconnect the electronic parking brake when you are about to start driving >>> page 217.

Switching off the engine

1. Stop the vehicle completely.
 2. Press and hold the brake pedal until the step 4 is performed.
 3. Move the selector lever to the **P** position.
 4. Connect the electronic parking brake >>> page 217.
- Briefly press the start-up button >>> **Fig. 194**. The **(START ENGINE STOP)** button blinks again. If the engine fails to switch off, perform an emergency disconnect >>> page 214.



>>> in Starter button on page 215



>>> page 214

Lights and visibility



Light switch







Fig. 36 Instrument console: light panel.

- Turn the switch to the required position >>> **Fig. 36**.

Sym- bol	Ignition switched off	Ignition is switched on
0	Fog lights, dipped beam and side lights off.	Daylight running lights switched on.

Symbol	Ignition switched off	Ignition is switched on
AUTO	The "Coming home", "Leaving home" and Welcome lights may be switched on.	Automatic control of dipped beam and daytime running light.
	Side light on.	Daylight running lights switched on.
	Dipped beam headlight off	Dipped beam switched on.

 **Rear fog light:** move the switch completely from positions **AUTO**,  or .

- Turn on fog lights: push the switch or turn it to the  position.

 >>>  in Side light and dipped beam headlight on page 132

 >>> page 132

Turn signal and main beam lever

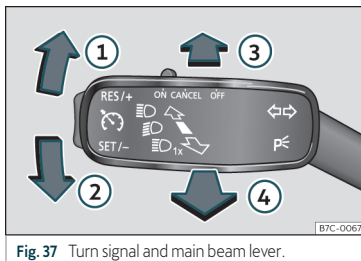



Fig. 37 Turn signal and main beam lever.

Move the lever to the required position:

- ① Right turn light: right-hand parking light (ignition switched off).
- ② Left turn light: left-hand parking light (ignition switched off).
- ③ Main beam on: control lamp  lit up on the instrument panel.
- ④ Light flash: on with the lever pushed. Control lamp  lit up.

Lever all the way down to switch it off.

 >>>  in Turn signal and main beam lever on page 133

 >>> page 133



Hazard warning lights



Fig. 38 Dashboard: switch for hazard warning lights.

Switched on, for example:

- When approaching a traffic jam
- In an emergency
- The vehicle has broken down
- When towing or being towed

 >>>  in Hazard warning lights  on page 137

 >>> page 136

Interior lights

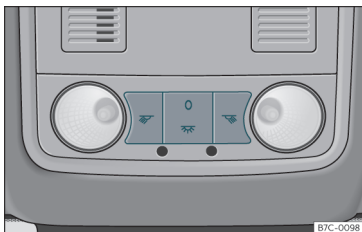

Fig. 39 Detail of headliner: front interior lighting.

Knob	Function
0	Switches interior lights off.
	Switches interior lights on.
Central position or	Door contact switch-on. The interior lights come on automatically when the vehicle is unlocked, a door is opened or the key is removed from the ignition. The light goes off a few seconds after all the doors are closed, the vehicle is locked or the ignition is switched on.
	Turning the reading light on and off

a) Depending on version.

Ambient light*: light guide on door panel. Lighting can be selected from 8 possible colours via the **CAR** menu and the **SETTINGS** function button.



>>> page 138

Windscreen wipers and window wiper blade

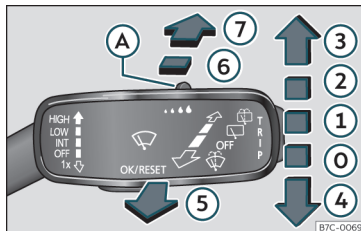

Fig. 40 Operating the windscreen wiper and rear wiper.

More the lever to the required position:

① **OFF** Windscreen wipers off.

More the lever to the required position:

- ① **INT** Windscreen wipers interval wipe. Using the control >>> Fig. 40 (A) adjust the interval (vehicles without rain sensor), or the sensitivity of the rain sensor.
- ② **LOW** Slow wipe.
- ③ **HIGH** Continuous wipe.
- ④ **1x** Short wipe. Brief press, short clean. Hold the lever down for more time to increase the wipe frequency.
- ⑤ Automatic wipe. The windscreen washer function is activated by pushing the lever forwards, and simultaneously the windscreen wipers start.
- ⑥ Interval wipe for rear window. The wiper will wipe the window approximately every six seconds.
- ⑦ The rear window wash function is activated by pressing the lever, and the rear wiper starts simultaneously.



>>> page 139

SOS

>>> page 54

Easy Connect

Vehicle menu settings

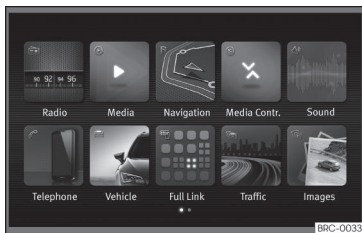

Fig. 41 Easy Connect: Main menu.

The actual number of menus available and the name of the various options will depend on the vehicle's electronics and equipment.

- Switch the ignition on.
- If the Infotainment System is off, switch it on.
- Press the Infotainment button **(MENU)** and then the **Vehicle** function button >>> Fig. 41.



Fig. 42 Easy Connect: Vehicle Menu.

- **OR:** Press the infotainment button **(CAR)** to open the **Vehicle** menu >>> Fig. 42.
- Press the **SETTINGS** function button to open the **Vehicle settings** menu.
- To select a function in the menu, press the desired button.

When the function button check box is activated , the function is active.

Pressing the menu button **(↩)** will always take you to the last menu used.

Any changes made using the settings menus are automatically saved on closing those menus.

Menu	Submenu	Possible setting	Description
ESC system	–	Selecting the ESC Sport mode or deactivating the electronic stability system (ESC)	>>> page 221
Tyres	Tyre pressure monitoring	Tyre pressure storing (Calibration)	>>> page 325
	Winter tyres	Activation and deactivation of the speed warning, adjusting the speed warning value	>>> page 329

»

The essentials

Menu	Submenu	Possible setting	Description
Lights	Light assist	Dynamic Light Assist, Light Assist, motorway function, turning-on time, headlamp range adjustment, automatic lights when raining, one-touch signalling, travel mode.	»» page 132
	Vehicle interior lighting	Brightness of instrument panel and controls	»» page 138
	Coming Home/Leaving Home function	Switch-on time of the "Coming home" and "Leaving home" functions	»» page 135 »» page 136
Driver assistance	ACC (adaptive cruise control)	Activation and deactivation: default distance level, driving profiles.	»» page 251
	Front Assist (emergency braking assistance system)	Activation and deactivation: Front Assist, advance warning, distance warning display	»» page 247
	Lane Assist (system warning you if you leave the lane)	Activation and deactivation of lane departure warning, adaptive lane guidance	»» page 260
	Detection of traffic signs	Display on the instrument panel, activation and deactivation of the speed warning	»» page 102
	Trailer	Trailer recognition (display of traffic signs for vehicles with trailer), use to calculate the route, maximum speed for trailer	»» page 296
	Fatigue detection	Activation and deactivation	»» page 100
Parking and manoeuvring	ParkPilot	Automatic activation, front volume, front sound treble, rear volume, rear sound treble, adjust Infotainment volume	»» page 283, »» page 287
	Auto Hold	Switching on and off when starting off	»» page 241
	Electric parking brake	Switching on and off automatically	»» page 219
	Braking while manoeuvring function	Switching on and off	»» page 286
	Displaying the parking space	Switching on and off	
Ambient lighting	-	Switching on and off, selecting brightness, colour, area or total	»» page 138

Menu	Submenu	Possible setting	Description
Mirrors and windscreen wipers	Mirrors	Synchronised regulation, fold in after parking, rear-view mirror heating, dim in the dark	»» page 20, »» page 142
	Windscreen wipers	Activate and deactivate automatic windscreen wipers in case of rain, wipe when reversing	»» page 32
Opening and closing	Electric windows control	Convenience opening, automatic closure in case of rain, automatic closure with central locking	»» page 127
	Central locking	Unlocking doors, automatic lock/unlock when driving, "Easy Open" audible confirmation, "Easy Entry" convenient entry function, automatic opening of the rear lid, interior monitoring	»» page 112
Instrument panel	-	Current consumption, average consumption, convenience consumers, ECO Advice, travelling time, distance travelled, average speed, digital speed display, speed warning, oil temperature, coolant temperature, reset data "when setting off", reset data for "total calculation", traffic signal detection	»» page 99
Date and time	-	Time source, time, select time zone, time format, date, date format	-
Units	-	Distance, speed, temperature, volume, fuel consumption, GNC consumption, electric consumption, pressure	-
Service	-	Chassis number, date of next service inspection, date of next oil change service	»» page 106
Factory settings	All	Restore all settings	-
	Individual	Lights, driver assistance, parking and manoeuvring, background lighting, rear view mirrors and windscreen wipers, opening and closing, instrument panel	-







WARNING

Any distraction may lead to an accident, with the risk of injury. Operating the Easy Connect system while driving could distract you from traffic.







Warning lamps













Control and warning lamps

Red warning lamps















	Notification central lamp: additional information on the instrument panel display
	Parking brake on >>> page 218.
	Fault in the brake system >>> page 218.
	Fault in the steering system >>> page 231.
	Driver or passenger has not fastened seat belt >>> page 62.
	Press the foot brake >>> page 252.





Yellow warning lamps

	Notification central lamp: additional information on the instrument panel display
	Front brake pads worn >>> page 218.
	Fault in ESC or disconnection caused by the system; OR ESC or ASR in operation >>> page 221.
	ASR manually deactivated; OR ESC in Sport mode >>> page 221.
	Fault in the ABS >>> page 221.
	Rear fog light switched on >>> page 132.

	Fault in the emission control system >>> page 236.
EPC	Fault in the petrol engine management >>> page 236.
	Fault in the steering system >>> page 231.
	Tyre monitor system >>> page 326.
	Fuel tank almost empty >>> page 105.
	Fault in airbag system and seat belt tensioners >>> page 73.
OFF 	Front passenger front airbag is disabled >>> page 73.
ON 	The front passenger front airbag is activated >>> page 73.
	Lane assist warning (Lane Assist) >>> page 260.
	Fault in the lighting of the vehicle >>> page 132.
	Low engine oil level >>> page 314.
	Fault in the gearbox >>> page 230.
	Windscreen cleaning fluid too low >>> page 139.

Other warning lamps

	Turn lights or emergency lights on >>> page 132.
	Trailer turn signals >>> page 132.
	Auto Hold activated >>> page 241.
	Press the foot brake >>> page 225.
	Speed regulator >>> page 242; OR speed limiter >>> page 243; OR Adaptive Cruise Control (ACC) >>> page 252.
	Lane assist warning (Lane Assist) >>> page 260.
	Main beam on or flasher on >>> page 132.
	Door(s), rear lid or bonnet open or not properly closed >>> page 97.
	Engine cooling fluid >>> page 106.
	Engine oil pressure >>> page 314.
	Fault in the battery >>> page 319.
	Main beam assist (Light Assist) >>> page 132.
	Hill descent control (HDC) >>> page 240.
SAFE	Electronic immobiliser active >>> page 120.
	Service interval display >>> page 106.
	Mobile telephone is connected via Bluetooth® >>> page 206.

	Mobile telephone battery charge status »» page 206.
	Risk of freezing »» page 97.
	Start-Stop system activated »» page 238.
	Start-Stop system unavailable »» page 238.

 »» ⚠ in Control and warning lamps on page 109

 »» page 109

Cruise control

Operating the cruise control system (CCS)*

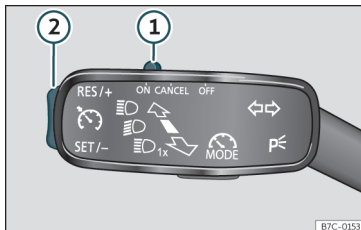

Fig. 43 Left of the steering column: CCS switch and controls.

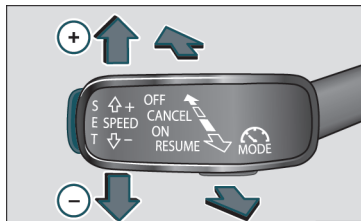

Fig. 44 On the left of the steering column: third lever to operate the CCS.

Operation of the turn signal lever

- Switching on the CCS: Move switch »» Fig. 43 ① to **ON**. The system is on. If no speed has been programmed, the system will not control it.
- Activate the CCS: Press button »» Fig. 43 ② in the **SET/-** area. The current speed is memorised and controlled.
- Temporarily switching off the CCS: Move switch »» Fig. 43 ① to **CANCEL** or push the brake. The cruise control system is switched off temporarily.
- Reactivating the CCS: Press button »» Fig. 43 ② in **RES/+**. The memorised speed is saved and controlled again.
- Increasing stored speed during CCS regulation: press button ② in **RES/+**. The vehicle accelerates until the new stored speed.

- Reducing stored speed during CCS regulation: press button ② in **SET/-** to lower the speed by 1 km/h (1 mph). Speed is reduced until reaching the new stored speed.
- Switching off the CCS: Move switch »» Fig. 43 ① to **OFF**. The system is disconnected and the memorised speed is deleted.

Operation using the third lever

- Switching on the CCS: move the third lever to **ON** »» Fig. 44. The system switches on but it does not control the speed as no speed has been programmed.
- Activating the CCS: press the button **SET** »» Fig. 44. It memorises and maintains the current speed.
- Temporarily switching off the CCS: move the lever to **CANCEL** »» Fig. 44 and release it or press the brake pedal. The cruise control system is switched off temporarily.
- Reactivating the CCS: move the lever to **RESUME** »» Fig. 44 and release it. The memorised speed is saved and controlled again.
- Disconnect the CCS: turn the key to position **OFF** »» Fig. 44. The system is disconnected and the memorised speed is deleted.

 »» ⚠ in Cruise control operation on page 243

 »» page 242

Gearbox

DSG Automatic transmission

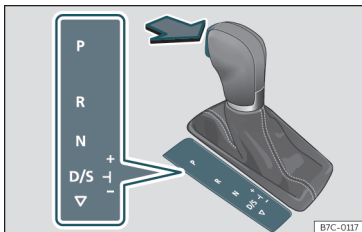

Fig. 45 Automatic transmission: selector lever positions.

- P** Parking lock
- R** Reverse gear
- N** Neutral (idling)
- D/S** Drive (forward)
- +/-** Tiptronic mode: pull the lever forwards (+) to go up a gear or backwards (-) to go down a gear.



»» ⚠ in Selector lever positions on page 225



»» page 224

SOS

»» page 38

Manual release of the selector lever

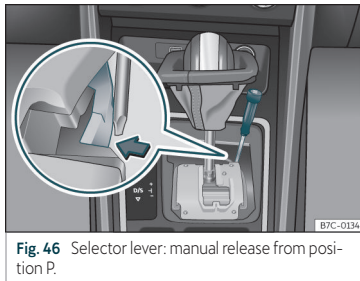

Fig. 46 Selector lever: manual release from position P.

Should the power supply be interrupted, there is a manual unlocking device located under the console of the selector lever, on the right. Releasing the selector lever requires a certain degree of practical skill.

- Unlock: use the flat part of a screwdriver blade.

Removing the cover from the selector lever

- Apply the handbrake (E) »» ⚠ to ensure that the car does not move.
- Carefully pull the corners of the selector lever boot and twist it upwards above the lever handle.

Releasing the selector lever

- Using a screwdriver, press and hold the yellow unlocking tab sideways »» **Fig. 46**.
- Press the interlock button on the selector lever and move the selector lever to position **N**.
- After carrying out the manual release, attach the selector lever boot on the gearbox console again.

If the power supply should ever fail (e.g. discharged battery) and the vehicle has to be pushed or towed, the selector lever must first be moved to position **N**, after operating the manual release mechanism.



WARNING

The selector lever may be moved out of position **P** only when the handbrake is firmly applied. If this does not work, secure the vehicle with the brake pedal. On a slope the vehicle could otherwise start to move inadvertently after shifting the selector lever out of position **P** - accident risk!

Air conditioning

How does Climatronic work?

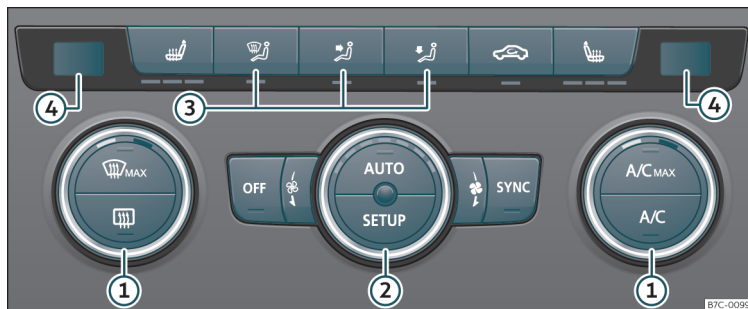



Fig. 47 In the centre console: Climatronic control panel.







To switch a specific function on, press the appropriate button. Press the button again to switch off the function.

The LED on each control lights up to indicate that the respective function of a control has been switched on.

Temperature ①	The left and right sides can be adjusted separately: turn the control to adjust the temperature
Fan ②	The power of the fan is automatically adjusted. The fan is also adjusted manually by turning the control.
Air distribution ③	The airflow adjusts automatically for comfort. You can also switch it on manually using the buttons ③.
④	Indications on the temperature display screen selected for the right and left sides.
 MAX Defrost function	The air drawn in from outside the vehicle is directed at the windscreen and air recirculation is automatically switched off. To defrost the windscreen more quickly, the air is dehumidified at temperatures over approximately +3°C (+38°F) and the fan runs at maximum output.
	The air is directed at the chest of driver and passengers by the dash panel air vents.



The essentials

	Air distribution towards the footwell.
	Upward air distribution.
	Heated rear window: this only works when the engine is running and switches off automatically after a maximum of 10 minutes.
	Air recirculation
	Seat heating buttons
A/C	Press the button to switch on or off the cooling system.
A/C MAX	Press the button to make maximum cooling capacity available. The recirculation of air and the cooling system turn on automatically and air distribution adjusts automatically to the position  .
SYNC	When the warning light for button lights up SYNC , the settings on the driver side also apply to the passenger side, press the button or the temperature control on the passenger side
AUTO	Automatic adjustment of temperature, fan, and air distribution. Press key: the lamp in button AUTO will lit up.
SETUP	Press the SETUP key: the air conditioning operation menu will be displayed on the Easy Connect system screen.
Switching off	Turn the blower control to the 0 position or press the OFF button.



>>>  in Introduction on page 158



>>> page 158

Fluid level control

Filling capacities

Tank level

Petrol engines	55 l, 8.5 l reserve
----------------	---------------------

Capacity of the windscreen washer fluid container

Versions without headlight washer system	approx. 3 litres
Versions with headlight washer system	approx. 5 litres

Fuel

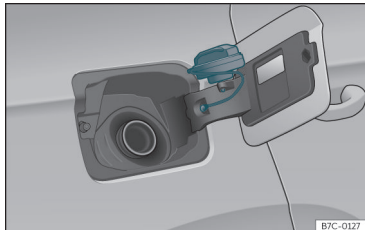

Fig. 48 Fuel tank flap with tank cap attached.

The flap that covers the tank cap is unlocked and locked automatically using the central locking.

Opening the fuel tank cap

- Open the fuel tank flap by pressing on the left side.
- Unscrew the cap by turning it to the left.
- Place it in the space on the hinge of the open flap >>> Fig. 48.

Closing the fuel tank cap

- Unscrew the cap by turning it to the right as far as it will go.
- Close the lid.



>>> ⚠ in Refuelling on page 308



>>> page 308

Oil

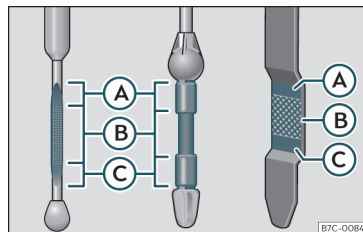

Fig. 49 Engine oil dipstick.

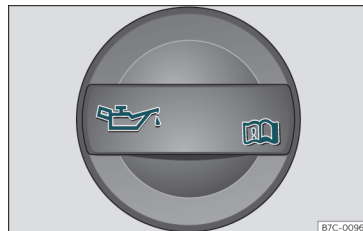



Fig. 50 In the engine compartment: Engine oil filler cap.

The level is measured using the dipstick located in the engine compartment >>>  page 313.

The oil indicator must be between zones (A) and (C). It can never go above zone (A). >>

- Zone **(A)**: do not add oil.
- Zone **(B)**: you can add oil but keep the level in that zone.
- Zone **(C)**: add oil until zone **(B)**.

Topping up engine oil

- Unscrew cap from oil filler opening.
- Add oil slowly.
- At the same time, check the level to ensure you do not add too much.
- When the oil level reaches at least zone **(B)**, unscrew the engine oil filler cap carefully.

Engine oil additives

No type of additive should be mixed with the engine oil. The deterioration caused by these additives is not covered by the warranty.

If the engine oil level is too low

You can get information about the correct engine oil for your vehicle in your specialised shop. If you have to change your engine oil, use this oil.

If the recommended engine oil is not available, in the event of an **emergency** you can change the oil **once** with a maximum of 0.5 L of the next oil until the next oil change:

- *Gasoline engines*: standard VW 504 00, VW 502 00, VW 508 00, ACEA C3 or API SN.

Have the oil changed by a specialised workshop.

 **EDGE** PROFESSIONAL

Recommended by CUPRA

CUPRA recommends using original CUPRA oil to guarantee high CUPRA engine performance.



>>>  in Changing engine oil on page 316



>>> page 313

Coolant



Fig. 51 Engine compartment: coolant expansion tank cap.

The coolant tank is located in the engine compartment >>>  page 313.

When the engine is cold, replace the coolant when the level is below **MIN**.

Coolant specifications

The engine cooling system is supplied from the factory with a specially treated mixture of water and at least 40 % of the additive **G13** (TL-VW 774 J), purple. This mixture gives the necessary frost protection down to -25°C (-13°F) and protects the light alloy parts of the engine cooling system against corrosion. It also prevents scaling and considerably raises the boiling point of the coolant.

To protect the cooling system, the percentage of additive must always be at least 40 %,

even in warm climates where anti-freeze protection is not required.

If for weather reasons further protection is necessary, the proportion of additive may be increased, but only up to 60 %; otherwise antifreeze protection will diminish and this will worsen cooling.

When the coolant is topped up, use a mixture of **distilled water** and at least 40 % of the G13 or G12 plus-plus (TL-VW 774 G) additive (both are purple) to obtain an optimum anti-corrosion protection >>> ⚠ in **Topping up coolant on page 317**. The mixture of G13 with G12 plus (TL-VW 774 F), G12 (red) or G11 (green-blue) engine coolants will significantly reduce anti-corrosion protection and should therefore be avoided >>> ⚠ in **Topping up coolant on page 317**.



>>> ⚠ in Topping up coolant on page 317



>>> page 316

Brake fluid



Fig. 52 Engine compartment: brake fluid reservoir cap.

The brake fluid reservoir is located in the engine compartment >>> 📖 page 313.

The level should be between the **MIN** and **MAX** marks. If it is below **MIN**, please visit a Technical Service.



>>> ⚠ in Top up brake fluid on page 317



>>> page 317

Windscreen washer

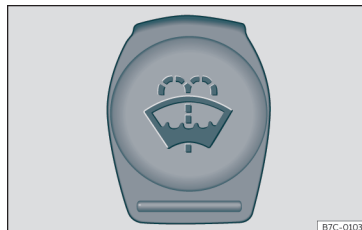

Fig. 53 In the engine compartment: cap of the windscreen washer tank.

The windscreen washer reservoir is located in the engine compartment >>> 📖 page 313.

To top up, mix water with a product recommended by CUPRA.

In cold temperatures, add anti-freeze.



>>> ⚠ in Checking and topping up the windscreen washer reservoir on page 318



>>> page 318

Battery

The battery is located in the engine compartment >>>  page 313. It does not require maintenance. It is checked as part of the Inspection Service.



>>>  in Important safety warnings for handling a vehicle battery on page 319



>>> page 318

Emergencies

Fuses

Fuse location

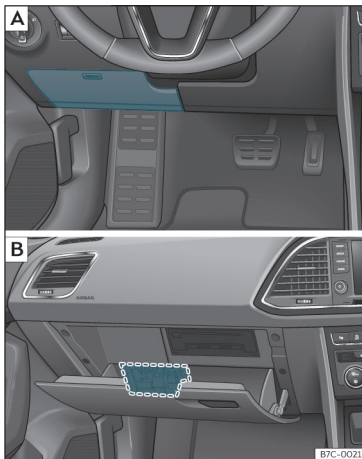

Fig. 54 [A] Left guide: fuse box cover on the driver-side dash panel. [B] Right guide: fuse box behind the glove compartment.

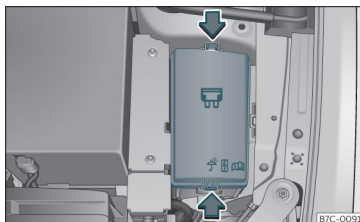



Fig. 55 In the engine compartment: lid of the fuse box.

Underneath the instrument panel (left-hand drive)

The fuse box is located behind the storage compartment >>> **Fig. 54 [A]**.

Behind the glove compartment (right-hand drive)

The fuse box is located behind the glove compartment >>> **Fig. 54 [B]**. To be able to access the fuse box >>>  page 86.

In the engine compartment

Press the locking tabs to release the fuse box cover >>> **Fig. 55**.

Identifying fuses situated below the dash panel by colours

Colour	Amp rating
Black	1

Colour	Amp rating
Purple	3
Light brown	5
Brown	7.5
Red	10
Blue	15
Yellow	20
White or transparent	25
Green	30
Orange	40



>>>  in Introduction on page 85



>>> page 85

Replacing a blown fuse

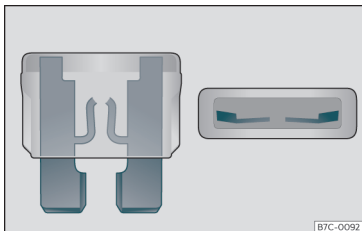

Fig. 56 Image of a blown fuse.

Preparation

- Switch off the ignition, lights and all electrical equipment.
- Open the corresponding fuse box >>> page 86.

Identifying a blown fuse

A fuse is blown if its metal strip is ruptured >>> **Fig. 56**.

- Point a lamp at the fuse to see if it has blown.

To replace a fuse

- Remove the fuse.
- Replace the blown fuse by one with an *identical* amperage rating (same colour and markings) and *identical* size.

- Replace the cover again or close the fuse box lid.

Bulbs

Changing bulbs

Note: LEDs have an estimated life that exceeds that of the vehicle. If an LED light fails, go to an authorised workshop for its replacement.

Light source used for each function

Full-LED main headlights

No bulbs may be replaced. All functions are with LEDs

LED rear lights	Type
Turn signal	PY21W LL
Reverse lights	W16W
The remaining functions work with LEDs	



>>> page 89

Action in the event of a puncture

What to do first

- Park the vehicle on a horizontal surface and in a safe place as far away from traffic as possible.
- Apply the handbrake.
- Switch on the hazard warning lights.
- Move the selector lever to the **P** position.
- If you are towing a trailer, unhitch it from your vehicle.
- Have the vehicle tool kit >>> page 78 and the spare wheel* ready >>> page 328.
- Observe the applicable legislation for each country (reflective vest, warning triangles, etc.).
- All occupants should leave the vehicle and wait in a safe place (for instance behind the roadside crash barrier).

WARNING

- Always observe the above steps and protect yourself and other road users.
- If you change the wheel on a slope, block the wheel on the opposite side of the car with a stone or similar to prevent the vehicle from moving.

Repairing a tyre with the anti-puncture kit

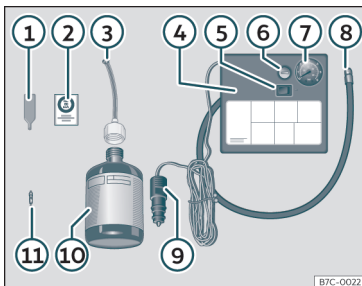

Fig. 57 Standard display: contents of the anti-puncture kit.

The anti-puncture kit is located under the floor panel in the luggage compartment.

Sealing the tyre

- Unscrew the tyre valve cap and insert. Use the >>> Fig. 57 ① tool to remove the insert. Place it on a clean surface.
- Shake the tyre sealant bottle vigorously >>> Fig. 57 ⑩.
- Screw the inflator tube >>> Fig. 57 ③ into the sealant bottle. The bottle's seal will break automatically.

- Remove the lid from the filling tube >>> Fig. 57 ③ and screw the open end of the tube into the tyre valve.
- With the tyre sealant bottle upside down, fill the tyre with the contents of the sealant bottle.
- Remove the bottle from the valve.
- Place the insert back into the tyre valve using the tool >>> Fig. 57 ①.

Inflating the tyre

- Screw the compressor tyre inflator tube >>> Fig. 57 ⑧ into the tyre valve.
- Check that the air bleed screw is closed >>> Fig. 57 ⑥.
- Start the engine and leave it running.
- Insert the connector >>> Fig. 57 ⑨ into the vehicle's 12-volt socket >>> page 149.
- Turn the air compressor on with the ON/OFF switch >>> Fig. 57 ⑤.
- Keep the air compressor running until it reaches 2.0 to 2.5 bar (29-36 psi/200-250 kPa). **A maximum of 8 minutes.**
- Disconnect the air compressor.
- If it does not reach the pressure indicated, unscrew the tyre inflator tube from the valve.
- Move the vehicle 10m so that the sealant is distributed throughout the tyre.

- Screw the compressor tyre inflator into the valve.
- Repeat the inflation process.
- If the indicated pressure still cannot be reached, the tyre is too badly damaged. Stop and request assistance from an authorised technician.
- Disconnect the air compressor. Unscrew the tyre inflator tube from the tyre valve.
- When the tyre pressure is between 2.5 and 2.0 bars, continue driving without exceeding 80 km/h (50 mph).
- Check the pressure again after 10 minutes >>> page 80.



>>> ⚠ in TMS (Tyre Mobility System)* on page 78



>>> page 78

Changing a wheel

Vehicle tool kit

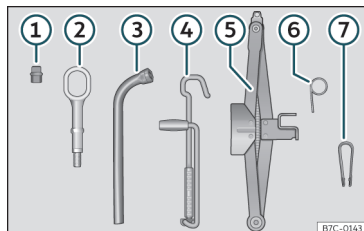

Fig. 58 Underneath the floor panel of the luggage compartment: on-board tools.

- ① Adapter for the anti-theft wheel bolts*
- ② Towline anchorage
- ③ Box spanner for wheel bolts*
- ④ Crank handle for jack
- ⑤ Jack*
- ⑥ Hook for extracting the central wheel trims*
- ⑦ Clip for removing the wheel bolt caps.



»» » ⚠ in What to do first on page 46



»» page 78

Wheel bolt caps



Fig. 59 Wheel: wheel bolts with caps.

Removal

- Fit the plastic clip (vehicle tools »» Fig. 58 ⑦) over the cap until it clicks into place »» Fig. 59.
- Remove the cap with the plastic clip.

Anti-theft wheel bolts

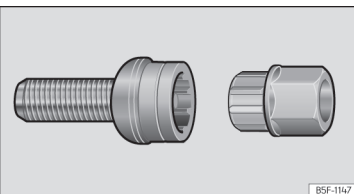

Fig. 60 Anti-theft wheel bolt with cap and adapter.

- Remove the cap*.
- Insert the special adapter (vehicle tools) onto the anti-theft wheel bolt and push it on as far as it will go.
- Insert the wheel brace (vehicle tools) onto the adapter as far as it will go.
- Remove the wheel bolt »» page 49.

i Note

Make a note of the code number of the anti-theft wheel bolt and keep it in a safe place, but not in your vehicle. If you need a new adapter, you can obtain it from the specialised CUPRA service or the SEAT Official Service, indicating the code number.

Loosening the wheel bolts



Fig. 61 Wheel: loosen the wheel bolts.

- Insert the box spanner (vehicle tools) onto the wheel bolt as far as it will go. An adapter is required to unscrew or tighten the anti-theft wheel bolts » page 48.
- Turn the wheel bolt approximately one turn to the left » Fig. 61 (arrow). To apply the required torque, hold the wheel brace at the end. If it is not possible to loosen a wheel bolt, carefully apply pressure with one foot on the end of the box spanner. Hold on to the vehicle for support and take care not to slip.

⚠ WARNING

Slightly loosen the wheel bolts (one turn) before raising the vehicle with the jack*. If not, an accident may occur.

Raising the vehicle

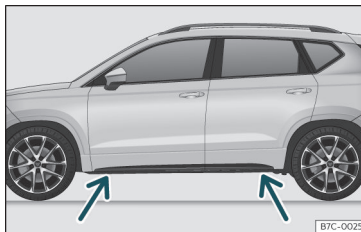

Fig. 62 Crossbar: brands.

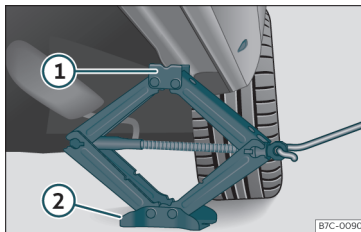

Fig. 63 Crossbar: mounting the jack on the vehicle.

- Place the jack* (vehicle tools) on firm ground. If necessary use a large, strong board or similar support. If the surface is slippery (for example tiles) place the jack on a rubber mat or similar to prevent it from slipping » ⚠.

- Find the support point on the strut (sunken area) closest to the wheel to be changed » Fig. 62.

- Turn the jack* crank handle, located below the strut support point, to raise it until the tab ① » Fig. 63 is below the housing provided.

- Align the jack* so that tab ① “grips” onto the housing provided on the strut and the mobile base ② is resting on the ground. The base plate ② should fall vertically with respect to the support point ①.

- Continue turning the jack* until the wheel is slightly lifted off the ground.

⚠ WARNING

- Make sure that the jack* remains stable. If the surface is slippery or soft, the jack* could slip or sink, respectively, with the resultant risk of injury.
- Only raise the vehicle with the jack* supplied by the manufacturer. Other jacks, even those approved for other CUPRA models could slip, with the consequent risk of injury.
- Only mount the jack* on the support points designed for this purpose on the strut, and always align the jack correctly. If you do not, the jack* could slip as it does not have an adequate grip on the vehicle: risk of injury!

»

- The height of the parked vehicle can change as a result of variations in temperature and loading.

ⓘ CAUTION

The vehicle must not be raised on the crossbar. Only place the jack* on the points designed for this purpose on the strut. Otherwise, the vehicle may be damaged.

Removing and fitting a wheel

Change the wheel after loosening the wheel bolts and raising the vehicle with the jack.

Taking off the wheel

- Unscrew the wheel bolts using the box spanner and place them on a clean surface.
- Take off the wheel.

Putting on the spare wheel

When fitting tyres with a compulsory rotation direction, observe the instructions in >>> page 50.

- Mount the wheel.
- Screw on the wheel bolts in position and tighten them loosely with a box spanner.
- Carefully lower the vehicle using the jack*.

- Tighten the wheel bolts in diagonal pairs using the wheel brace.

The wheel bolts should be clean and turn easily. Before fitting the spare wheel, inspect the wheel condition and hub mounting surfaces. These surfaces must be clean before fitting the wheel.



Tyres with compulsory direction of rotation

A directional tread pattern can be identified by the arrows on the sidewall that point in the direction of rotation. Always observe the direction of rotation indicated when fitting the wheel to guarantee optimum properties of this type of tyres with regard to grip, noises, wear and aquaplaning.

If it is absolutely necessary to fit the spare tyre* against the direction of rotation, drive with care as this means the tyre does not offer optimum driving properties. This is of particular importance when the road surface is wet.

To return to directional tread tires, replace the punctured tyre as soon as possible and restore the obligatory direction of rotation of all tyres.

Subsequent work

- *Alloy wheels*: replace the wheel bolt caps.
- Return all tools to their proper storing location.
- If the replaced wheel does not fit in the spare wheel housing, store it safely in the luggage compartment >>>  page 150.
- Check the tyre pressure of the newly mounted tyre as soon as possible.
- In vehicles fitted with a tyre pressure indicator, adjust the pressure and store the reading in the radio/Easy Connect system* >>>  page 325.
- Have the tightening torque of the wheel bolts checked as soon as possible with a torque wrench (it should be 140 Nm). Meanwhile, drive carefully.
- Have the flat tyre replaced as quickly as possible.

Snow chains

Use

Snow chains should only be used on the front wheels.

Check that they are correctly seated after driving for a few yards; correct the position if necessary, in accordance with the

manufacturer's fitting instructions. Keep your speed below 50 km/h (30 mph).

If there is a danger of being trapped despite having mounted the chains, it is best to disable the driving wheels (ASR) in the ESC »  page 223, Connecting/disconnecting the ESC.

Snow chains will improve *braking ability* as well as *traction* in winter conditions.

For technical reasons snow chains may only be used with the following wheel rim/tyre combination.

225/50 R18	Chains with links of maximum 9 mm
------------	-----------------------------------

225/45 R19	Chains with links of maximum 9 mm
------------	-----------------------------------

Other dimensions do not allow chains

Remove any central wheel trims and the rim ring before fitting snow chains.

Remove the chains when roads are free of snow. Driving characteristics worsen, and the wheels become damaged quickly and may even be rendered unusable.

Emergency towing of the vehicle

Towing



Fig. 64 Right side of the front bumper: towline anchorage screwed in.

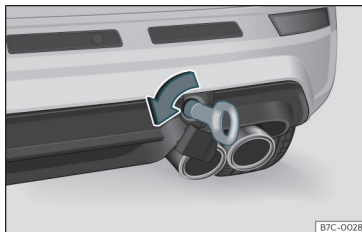



Fig. 65 Right side of the rear bumper: towline anchorage screwed in.

Towline anchorages

Attach the bar or rope to the towline anchorages.

The towline anchorages are located under the floor panel in the luggage compartment, next to the vehicle tools »  page 78.

Screw the towline anchorage into the screw connection » **Fig. 64** or » **Fig. 65** and tighten it with the wheel brace.

Tow rope or tow bar

The tow bar offers increased safety and a lower risk of damage.

The tow rope is recommended when there is no tow bar. It must be elastic so that it does not damage the vehicle.

Notes for the driver of the towing vehicle

- The tow rope must be taut before you drive off.
- Release the clutch very carefully when starting the vehicle (manual gearbox), or accelerate gently (automatic gearbox).

Driving style

Towing requires some experience, especially when using a tow rope. Both drivers should realise how difficult it is to tow a vehicle. Inexperienced drivers should not attempt to tow. »

Do not pull too hard with the towing vehicle and take care to avoid jerking the tow rope. When towing on an unpaved road, there is always a risk of overloading and damaging the anchorage points.

Switch on the ignition so that the turn signals, windscreen wipers and windscreen washer can work. Ensure that the steering wheel is unlocked and moves freely.

To brake, press the brake pedal firmly. The brake servo does not work when the engine is switched off.

The power steering only works when the ignition is switched on and the vehicle is moving, provided that the battery is sufficiently charged. Otherwise, it will need more force.

Ensure that the tow rope remains taut at all times.



>>> in Introduction on page 81



>>> page 81

Tow-starting

If the engine will not start, first try starting it using the battery of another vehicle >>> page 52. You should only attempt to tow-start a vehicle if charging the battery

does not work. This is done by leveraging wheel movement.

When tow-starting a vehicle with a **petrol engine**, do not tow it more than a *short* distance, otherwise unburned fuel can enter the catalytic converter.

- Engage 2nd or 3rd gear before moving off.
- Press the clutch and hold the pedal down.
- Switch the ignition on.
- Once both vehicles are moving, release the clutch.
- As soon as the engine has started, press the clutch and move the gear lever to neutral.

How to jump start

Jump leads

The jump lead must have a sufficient wire cross section.

If the engine fails to start because of a discharged battery, the battery can be connected to the battery of another vehicle to start the engine.

Jump leads must comply with standard **DIN 72553** (see cable manufacturer's instructions). The wire cross section must be at

least 25 mm² for petrol engines and at least 35 mm² for diesel engines.

Note

- The vehicles must not touch each other, otherwise electricity could flow as soon as the positive terminals are connected.
- The discharged battery must be properly connected to the on-board network.

How to jump start: description

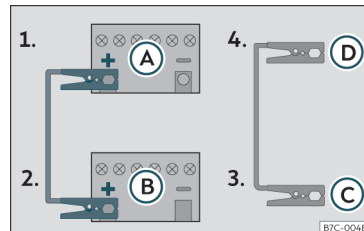

Fig. 66 Diagram of connections for vehicles with Start Stop system

Jump lead terminal connections

>>> Fig. 66

1. Switch off the ignition of both vehicles >>> .

2. Connect one end of the *red* jump lead to the positive (+) terminal of the vehicle with the flat battery (A).
3. Connect the other end of the *red* jump lead to the positive terminal (+) in the vehicle providing assistance (B).
4. Connect one end of the *black* jump lead (C) to a suitable ground terminal, to a solid piece of metal in the engine block, or to the engine block itself.
5. Connect the other end of the *black* jump lead (D) to a solid metal component bolted to the engine block or to the engine block itself of the vehicle with the flat battery. Do not connect it to a point near the battery.
6. Position the leads in such a way that they cannot come into contact with any moving parts in the engine compartment.

Starting

7. Start the engine of the vehicle with the boosting battery and let it run at idling speed.
8. Start the engine of the vehicle with the flat battery and wait for 2 or 3 minutes until the engine is running.

Removing the jump leads

9. Before you remove the jump leads, switch off the dipped beam headlights if they are switched on.
10. Turn on the heater blower and heated rear window in the vehicle with the flat battery. This helps minimise voltage peaks which are generated when the leads are disconnected.
11. When the engine is running, disconnect the leads in reverse order to the details given above.

Make sure the battery clamps have sufficient metal-to-metal contact with the battery terminals.

If the engine fails to start after about 10 seconds, switch off the starter and try again after about 1 minute.

WARNING

- Please note the safety warnings referring to working in the engine compartment >>>  page 310.
- The battery providing assistance must have the same voltage as the flat battery (12V) and approximately the same capacity (see imprint on battery). Failure to comply could result in an explosion.
- Never use jump leads when one of the batteries is frozen. Danger of explosion! Even after the battery has thawed, battery

acid could leak and cause chemical burns. If a battery freezes, it should be replaced.

- Keep sparks, flames and lighted cigarettes away from batteries, danger of explosion. Failure to comply could result in an explosion.
- Observe the instructions provided by the manufacturer of the jump leads.
- Do not connect the negative cable from the other vehicle directly to the negative terminal of the flat battery. The gas emitted from the battery could be ignited by sparks. Danger of explosion.
- Never attach the negative cable to fuel system components or the brake lines in the other vehicle.
- The non-insulated parts of the battery clamps must not be allowed to touch. The jump lead attached to the positive battery terminal must not touch metal parts of the vehicle, this can cause a short circuit.
- Position the leads in such a way that they cannot come into contact with any moving parts in the engine compartment.
- Do not lean on the batteries. This could result in chemical burns.

Note

The vehicles must not touch each other, otherwise electricity could flow as soon as the positive terminals are connected.

Changing the wiper blades

Windscreen wipers service position

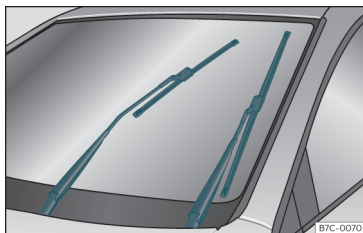

Fig. 67 Wipers in service position.

The wiper arms can be raised when the wipers are in service position >>> Fig. 67.

- Close the bonnet >>> page 310.
- Switch the ignition on and off.
- Press the windscreen wiper lever downwards briefly ④ >>> page 32.

Before driving, always lower the wiper arms. Using the windscreen wiper lever, the windscreen wiper arms return to their initial position.



>>> page 81

Changing the windscreen and rear window wiper blades

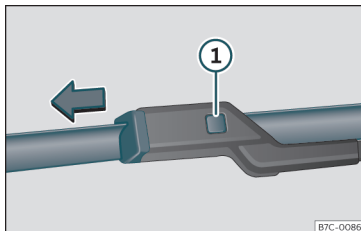

Fig. 68 Changing the windscreen wiper blades

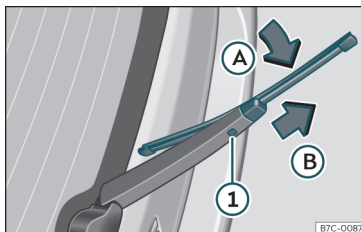

Fig. 69 Changing the rear wiper blade

Raising and lowering windscreen wiper arms

- Place the windscreen wipers in the service position >>> page 54.
- Grip the wiper arms **only** by the blade's fastening point.

Cleaning windscreen wiper blades

- Raise the wiper arms.
- Use a soft cloth to remove dust and dirt from the windscreen wiper blades.
- If the blades are very dirty, a sponge or damp cloth may be used >>> ① in Changing the windscreen and rear window wiper blades on page 81.

Changing the windscreen wiper blades

- Lift and unfold the wiper arms.
- Press and hold release button >>> Fig. 68 ① and pull gently on the wiper blade in the direction of the arrow.
- Fit a new wiper blade of the **same length and design** on to the wiper arm and hook it into place.
- Rest the wiper arms back onto the windscreen.

Changing the rear wiper blade

- Lift and fold the wiper arm.
- Turn the blade slightly >>> Fig. 69 (arrow A).
- Hold down the release button ① while gently pulling the blade in the direction of arrow B.

- Insert a new blade of the **same length and type** in the rear wiper arm in the opposite direction to the arrow **(B)** and hook into place button **(1)**.
- Replace the wiper arm on the rear window.



» »  in Changing the windscreen and rear window wiper blades on page 81



» » page 81

Safety

Safe driving

Safety first!

WARNING

- This manual contains important information about the operation of the vehicle, both for the driver and the passengers. The other sections of the on-board documentation also contain further information that you should be aware of for your own safety and for the safety of your passengers.
- Ensure that the on-board documentation is kept in the vehicle at all times. This is especially important when lending or selling the vehicle to another person.

Advice about driving

Before setting off

For your own safety and the safety of your passengers, always note the following points before every trip:

- Make sure that the vehicle's lights and turn signals are working properly.
- Check tyre pressure.

- Ensure that all windows provide a clear and good view of the surroundings.
- Make sure all luggage is secured >>> page 150.
- Make sure that no objects can interfere with the pedals.
- Adjust front seat, head restraint and mirrors properly according to your size.
- Ensure that the passengers in the rear seats always have the head restraints in the in-use position >>> page 61.
- Instruct passengers to adjust the head restraints according to their height.
- Protect children with appropriate child seats and properly applied seat belts >>> page 73.
- Assume the correct sitting position. Instruct your passengers also to assume a proper sitting position >>> page 57.
- Fasten your seat belt securely. Instruct your passengers also to fasten their seat belts properly >>> page 62.

What affects driving safety?

As a driver, you are responsible for yourself and your passengers. When your concentration or driving safety is affected by any cir-

cumstance, you endanger yourself as well as others on the road >>> , for this reason:

- Always pay attention to traffic and do not get distracted by passengers or telephone calls.
- Never drive when your driving ability is impaired (e.g. by medication, alcohol, drugs).
- Observe traffic laws and speed limits.
- Always reduce your speed as appropriate for road, traffic and weather conditions.
- When travelling long distances, take breaks regularly - at least every two hours.
- If possible, avoid driving when you are tired or stressed.

WARNING

When driving safety is impaired during a trip, the risk of injury and accidents increases.

Safety equipment

Never put your safety or the safety of your passengers in danger. In the event of an accident, the safety equipment may reduce the risk of injury. The following points cover

part of the safety equipment in your CU-PRA¹⁾:

- three-point seat belts,
- belt tension limiters for the front and rear side seats,
- belt tensioners for the front and rear side seats,
- front airbags,
- knee airbags,
- side airbags in the front seat backrests,
- head-protection airbags,
- “ISOFIX” anchor points for child seats in the rear side seats with the “ISOFIX” system,
- height-adjustable front head restraints,
- rear head restraints with in-use position and non-use position,
- adjustable steering column.

The safety equipment mentioned above works together to provide you and your passengers with the best possible protection in the event of an accident. However, these safety systems can only be effective if you and your passengers are sitting in a correct position and use this equipment properly.

Safety is everyone's business!

Correct position of the vehicle occupants

Correct sitting position for the driver

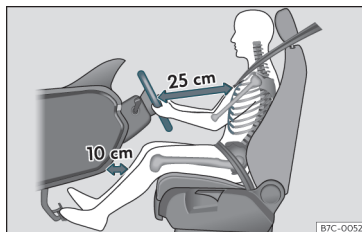

Fig. 70 The proper distance between driver and steering wheel.

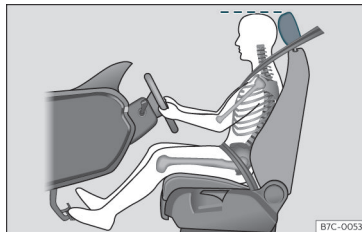

Fig. 71 Correct head restraint position for the driver.

For your own safety and to reduce the risk of injury in the event of an accident, we recommend the following adjustments for the driver:

- Adjust the steering wheel so that there is a distance of at least 25 cm between the steering wheel and the centre of your chest >>> **Fig. 70**.
- Move the driver's seat forwards or backwards so that you are able to press the accelerator, brake and clutch pedals to the floor with your knees still slightly angled >>> **△**.
- Ensure that you can reach the highest point of the steering wheel.
- Adjust the head restraint so that its upper edge is at the same level as the top of your head, or as close as possible to the same level as the top of your head >>> **Fig. 71**.
- Move the seat backrest to an upright position so that your back rests completely against it.
- Fasten your seat belt securely >>> **page 62**.
- Keep both feet in the footwell so that you have the vehicle under control at all times.

Adjustment of the driver's seat >>> **page 143**. »

¹⁾ Depending on the version/market.

⚠ WARNING

- An incorrect sitting position of the driver can lead to severe injuries.
- Adjust the driver's seat so that there is at least 25 cm distance between the centre of the chest and the centre of the steering wheel >>> Fig. 70. If you are sitting closer than 25 cm, the airbag system cannot protect you properly.
- If your physical constitution prevents you from maintaining the minimum distance of 25 cm, contact a specialised workshop. The workshop will help you decide if special specific modifications are necessary.
- When driving, always hold the steering wheel with both hands on the outside of the ring at the 9 o'clock and 3 o'clock positions. This reduces the risk of injury when the driver airbag is triggered.
- Never hold the steering wheel at the 12 o'clock position, or in any other manner (e.g. in the centre of the steering wheel). In such cases, if the airbag is triggered, you may sustain injuries to the arms, hands and head.
- To reduce the risk of injury to the driver during sudden braking manoeuvres or an accident, never drive with the backrest tilted far back! The airbag system and seat belts can only provide optimal protection when the backrest is in an upright position and the driver is wearing his or her seat belt correctly.

- Adjust the head restraint properly to achieve optimal protection.

Adjusting the steering wheel position

Read the additional information carefully >>>  page 21.

⚠ WARNING

- Never adjust the position of the steering wheel when the vehicle is moving, as this could cause an accident.
- Move the lever up firmly so the steering wheel position does not accidentally change during driving. risk of accident!
- Make sure you are capable of reaching and firmly holding the upper part of the steering wheel: risk of accident!
- If you adjust the steering wheel so that it points towards your face, the driver airbag will not protect you properly in the event of an accident. Make sure that the steering wheel points towards your chest.

Correct position for the front passenger

For your own safety and to reduce the risk of injury in the event of an accident, we recom-

mend the following adjustments for the front passenger:

- Move the front passenger seat back as far as possible >>> .
- Move the seat backrest to an upright position so that your back rests completely against it.
- Adjust the head restraint so that its upper edge is at the same level as the top of your head, or as close as possible to the same level as the top of your head >>> page 60.
- Always keep both feet in the footwell in front of the front passenger seat.
- Fasten your seat belt securely >>> page 62.

It is possible to deactivate the front passenger airbag in **exceptional circumstances** >>> page 72.

Adjusting the front passenger seat >>> page 143.

⚠ WARNING

- An incorrect sitting position of the front passenger can lead to severe injuries.
- Adjust the front passenger seat so that there is at least 25 cm between your chest and the dash panel. If you are sitting closer than 25 cm, the airbag system cannot protect you properly.
- If your physical constitution prevents you from maintaining the minimum distance of

25 cm, contact a specialised workshop. The workshop will help you decide if special specific modifications are necessary.

- Always keep your feet in the footwell when the vehicle is moving; never rest them on the dash panel, out the window or on the seat. An incorrect sitting position exposes you to an increased risk of injury in case of a sudden braking or an accident. If the airbag is triggered, you could sustain severe injuries due to an incorrect sitting position.
- To reduce the risk of injury to the front passenger in events such as sudden braking manoeuvres or an accident, never travel with the backrest tilted far back! The airbag system and seat belts can only provide optimal protection when the backrest is in an upright position and the front passenger is wearing his or her seat belt properly. The further the seat backrests are tilted to the rear, the greater the risk of injury due to incorrect positioning of the belt web or to the incorrect sitting position!
- Adjust the head restraint correctly in order to achieve maximum protection.

Correct sitting position for rear seat passengers

To reduce the risk of injury in the event of a sudden braking manoeuvre or an accident,

passengers on the rear seat bench must consider the following:

- Sit up straight.
- Adjust the head restraint to the correct position >>> page 61.
- Always keep both feet in the footwell in front of the rear seat.
- Fasten your seat belt securely >>> page 62.
- Use an appropriate child restraint system when you take children in the vehicle >>> page 73.

WARNING

- If the passengers in the rear seats are not sitting properly, they could sustain severe injuries.
- Adjust the head restraint correctly in order to achieve maximum protection.
- Seat belts can only provide optimal protection when seat backrests are in an upright position and the vehicle occupants are wearing their seat belts correctly. If passengers in the rear seats are not sitting in an upright position, the risk of injury due to incorrect positioning of the seat belt increases.

Examples of incorrect sitting positions

Seat belts can provide optimal protection only when the belt webs are properly positioned. Incorrect sitting positions substantially reduce the protective function of seat belts and increase the risk of injury due to incorrect seat belt position. As the driver, you are responsible for all passengers, especially children.

- Never allow anyone to assume an incorrect sitting position in the vehicle while travelling >>> .

The following list contains examples of sitting positions that could be dangerous for all vehicle occupants. The list is not complete, but we would like to make you aware of this issue.

Therefore, whenever the vehicle is in motion:

- Never stand in the vehicle.
- Never stand on the seats.
- Never kneel on the seats.
- Never tilt your seat backrest far to the rear.
- Never lean against the dash panel.
- Never lie on the rear bench.
- Never sit on the front edge of a seat.
- Never sit sideways.
- Never lean out of a window.

- Never put your feet out of a window.
- Never put your feet on the dash panel.
- Never put your feet on the surface of a seat.
- Do not allow anyone to travel in the footwell.
- Never travel without wearing the seat belt.
- Do not allow anyone to travel in the luggage compartment.

⚠ WARNING

- Any incorrect sitting position increases the risk of severe injuries. Sitting in an incorrect position exposes the vehicle occupants to severe injuries if airbags are triggered, by striking a vehicle occupant who has assumed an incorrect sitting position.
- Before the vehicle moves, assume the proper sitting position and maintain it throughout the trip. Before every trip, instruct your passengers to sit properly and to stay in this position during the trip
»» page 57, Correct position of the vehicle occupants.

Correct adjustment of front head restraints

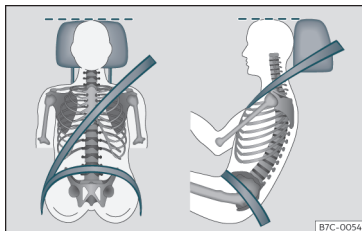

Fig. 72 Correctly adjusted head restraint as viewed from the front and the side.

Read the additional information carefully »» page 19.

Properly adjusted head restraints are an important part of passenger protection and can reduce the risk of injuries in most accident situations.

- Adjust the head restraint so that its upper edge is, as far as possible, at the same level as the top of your head, or at the very least, at eye level »» **Fig. 72**.

⚠ WARNING

- Travelling with the head restraints removed or improperly adjusted increases the risk of severe injuries. An improper adjustment of the head restraints may cause

death in an accident and increase the risk of suffering injuries during abrupt braking actions or unexpected manoeuvres.

- The head restraints must always be adjusted according to the height of the passenger.

Correct adjustment of rear head restraints

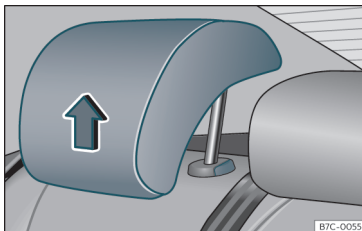

Fig. 73 Head restraints in the correct position.

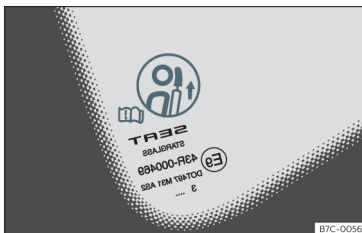

Fig. 74 Head restraint position warning label.

Properly adjusted head restraints are an important part of the passenger protection and can reduce the risk of injuries in most accident situations

Rear head restraints

- The rear head restraints have 2 positions: **use** and **non-use**.
- One position for **use** (head restraint raised) >>> Fig. 73. In this position, the head restraints are used normally, protecting passengers along with the rear seat belts.
- And one position for **non-use** (head restraint lowered).
- To fit the head restraints in position for use, pull on the edges with both hands in the direction of the arrow.

⚠ WARNING

- Under no circumstances should the rear passengers travel while the head restraints are in the non-use position. See the warning label located on the rear side fixed window >>> Fig. 74.
- Do not swap the centre rear head restraint with either of the outer seat rear head restraints. Risk of injury in case of an accident!

ⓘ CAUTION

Note the instructions on the adjustment of the head restraints >>> page 144.

Pedal area

Pedals

- Ensure that you can always press the accelerator, brake and clutch pedals unimpaired to the floor.
- Ensure that the pedals can return unimpaired to their initial positions.
- Ensure that the floor mats are securely fastened during the trip and do not obstruct the pedals >>> ⚠.

Only use floor mats which leave the pedals clear and which are secured to prevent them from slipping. You can obtain suitable floor mats from a specialised dealership. Fasteners* for floor mats are fitted in the footwells.

If a brake circuit fails, the brake pedal must be pressed down thoroughly in order to stop the vehicle.

Wear suitable footwear

Always wear shoes which support your feet properly and give you a good feeling for the pedals.

⚠ WARNING

- Restricting pedal operation can lead to critical situations while driving. »

- Never lay or fit floor mats or other floor coverings over the original floor mats. This would reduce the pedal area and could obstruct the pedals. Risk of accident.
- Never place objects in the driver footwell. An object could move into the pedal area and impair pedal operation. In the event of a sudden driving or braking manoeuvre, you will not be able to operate the brake, clutch or accelerator pedal. Risk of accident!

Seat belts

Why wear a seat belt

Number of seats

Your vehicle has **five** seats, two in the front and three in the rear. Each seat is equipped with a three-point seat belt.

In some versions, your vehicle is approved **only** for four seats. Two front seats and two rear seats.

WARNING

- Never transport more than the permitted amount of people in your vehicle.
- Every vehicle occupant must properly fasten and wear the seat belt belonging to his or her seat. Children must be protected with an appropriate child restraint system.

Seat belt control lamp*



Fig. 75 Dashboard: right rear seat occupied and corresponding seat belt fastened display.



It lights up red

Driver or passenger has not fastened seat belt.

The control lamp illuminates to remind the driver to fasten his seat belt.

Before starting the vehicle:

- Fasten your seat belt securely.
- Instruct your passengers to fasten their seat belts properly before driving off.
- Protect children by using a child seat according to the child's height and weight.

When starting to drive, if the vehicle's speed surpasses approx. 25 km/h (15 mph) and the seat belts are not fastened or are unfastened during the drive, a warning sound will be

heard for a few seconds. The warning light will also flash 🚗.

The lamp 🚗 goes out when the driver and passenger seat belts are fastened with the ignition switched on.

Rear seat belts fastened display*

Depending on the model version, when the ignition is switched on, the seat belt status display >>> **Fig. 75** on the instrument panel informs the driver whether the passengers in the rear seats have fastened their seat belts. The 🚗 symbol indicates that the passenger in this seat has fastened "his or her" seat belt.

When a seat belt in the rear seats is fastened or unfastened, the seat belt status is displayed for approximately 30 seconds. The indication can be hidden by pressing the **0.0/SET** button on the dash panel.

The seat belt status flashes for a maximum of 30 seconds when a seat belt in the rear seats is unfastened while the vehicle is in motion. An audible warning will also be heard if the vehicle is travelling at over 25 km/h (15 mph).

The protective function of seat belts



Fig. 76 Drivers with properly worn seat belts will not be thrown forward in the event of sudden braking.

Properly worn seat belts hold the occupants in the proper position. They also help prevent uncontrolled movements that may result in serious injury and reduce the risk of being thrown out of the vehicle in case of an accident.

Vehicle occupants wearing their seat belts correctly benefit greatly from the ability of the belts to absorb kinetic energy. In addition, the front part of your vehicle and other passive safety features (such as the airbag system) are designed to absorb the kinetic energy released in a collision. Taken together, all these features reduce the releasing kinetic energy and consequently, the risk of injury. This is why it is so important to fasten seat belts before every trip, even when "just driving around the corner".

Ensure that your passengers wear their seat belts as well. Accident statistics have shown that wearing seat belts is an effective means of substantially reducing the risk of injury and improving the chances of survival when involved in a serious accident. Furthermore, properly worn seat belts improve the protection provided by airbags in the event of an accident. For this reason, wearing a seat belt is required by law in most countries.

Although your vehicle is equipped with airbags, the seat belts must be fastened and worn. The front airbags, for example, are only triggered in some cases of head-on collision. The front airbags will not be triggered during minor frontal or side collisions, rear-end collisions, overturns or accidents in which the airbag trigger threshold value in the control unit is not exceeded.

Therefore, you should always wear your seat belt and ensure that all vehicle occupants have fastened their seat belts properly before you drive off!

Important safety instructions for the use of seat belts

- Always wear the seat belt as described in this section.
- Ensure that the seat belts can be fastened at all times and are not damaged. »

WARNING

- If seat belts are worn incorrectly or not at all, the risk of severe injuries increases. The optimal protection from seat belts can be achieved only if you use them properly.
- Fasten your seat belt before every trip - even when driving in town. Other vehicle occupants must also wear the seat belts at all times, otherwise they run the risk of being injured.
- The seat belt cannot offer its full protection if the seat belt is not positioned correctly.
- Never allow two passengers (even children) to share the same seat belt.
- Always keep both feet in the footwell in front of your seat as long as the vehicle is in motion.
- Never unbuckle a seat belt while the vehicle is in motion. Risk of fatal injury.
- The seat belt must never be twisted while it is being worn.
- The seat belt should never lie on hard or fragile objects (such as glasses or pens, etc.) because this can cause injuries.
- Do not allow the seat belt to be damaged or jammed, or to rub on any sharp edges.
- Never wear the seat belt under the arm or in any other incorrect position.
- Bulky and unfastened clothing (such as an overcoat over a sweater) impairs the

proper fit and function of the seat belts, reducing their capacity to protect.

- The slot in the seat belt buckle must not be blocked with paper or other objects, as this can prevent the latch plate from engaging securely.
- Never use seat belt clips, fastening rings or similar items to alter the position of the belt webbing.
- Frayed or torn seat belts or damage to the connections, belt retractors or parts of the buckle could cause severe injuries in the event of an accident. Therefore, you must check the condition of all seat belts at regular intervals.
- Seat belts which have been worn in an accident and have been stretched must be replaced by a specialised workshop. Renewal may be necessary even if there is no apparent damage. The belt anchorage should also be checked.
- Do not attempt to repair a damaged seat belt yourself. The seat belts must not be removed or modified in any way.
- The belts must be kept clean, otherwise the retractors may not work properly.

Head-on collisions and the laws of physics



Fig. 77 A driver not wearing a seat belt is thrown forward violently.



Fig. 78 The unbelted passenger in the rear seat is thrown forward violently, hitting the driver who is wearing a seat belt.

The effects of the laws of physics in the case of a head-on collision are easy to explain: the moment a vehicle starts moving, a type of energy called “kinetic energy” starts

acting on both the vehicle and its passengers.

The amount of “kinetic energy” depends on the speed of the vehicle and on the weight of the vehicle and of its passengers. The higher they are, the more energy there is to be “absorbed” in the event of an accident.

The most significant factor, however, is the speed of the vehicle. If the speed doubles from 25 km/h (15 mph) to 50 km/h (30 mph), for example, the corresponding kinetic energy is multiplied by four.

Given that the passengers of the vehicle in our example do not have their seat belts fastened, in the event of a collision the entire amount of the passengers' kinetic energy will be only absorbed by the mentioned impact.

Even at speeds of 30 km/h (19 mph) to 50 km/h (30 mph), the forces acting on bodies in a collision can easily exceed one tonne (1000 kg). At greater speed these forces are even higher.

Vehicle occupants not wearing seat belts are not “attached” to the vehicle. In a head-on collision, they will move forward at the same speed their vehicle was travelling just before the impact. This example applies not only to head-on collisions, but to all accidents and collisions.

Even at low speeds the forces acting on the body in a collision are so great that it is not

possible to brace oneself with one's hands. In a frontal collision, unbelted passengers are thrown forward and will make violent contact with the steering wheel, dash panel, windscreen or whatever else is in the way »» Fig. 77.

It is also important for rear passengers to wear seat belts properly, as they could otherwise be thrown forward violently through the vehicle interior in an accident. Passengers in the rear seats who do not use seat belts endanger not only themselves but also the front occupants »» Fig. 78.

How to properly adjust your seat belt

Fastening and unfastening your seat belt

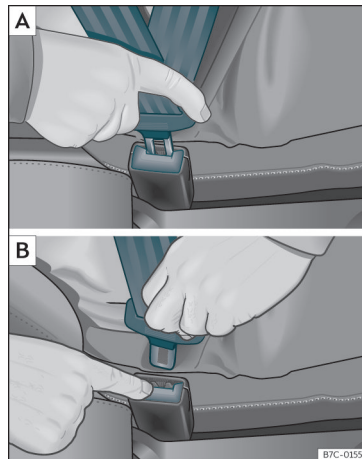

Fig. 79 Positioning and removing the seat belt buckle.

»

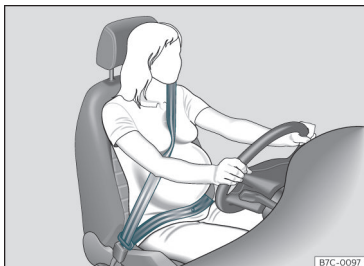

Fig. 80 Position of seat belt during pregnancy.

Read the additional information carefully

» page 20.

Fasten your seat belt

The seat belt cannot offer its full protection if the seat belt is not positioned correctly.

- Adjust the seat and head restraint correctly.
- To fasten the belt, take hold of the latch plate and pull it slowly across your chest and lap.
- Insert the latch plate into the buckle for the appropriate seat and push it down until it is securely locked with an audible click
» **Fig. 79 A.**

- Pull the belt to ensure that the latch plate is securely engaged in the buckle.

The seat belts are equipped with an automatic retractor on the shoulder strap. Full freedom of movement is permitted when the shoulder belt is pulled slowly. However, during sudden braking, during travel in steep areas or bends and during acceleration, the automatic retractor on the shoulder belt is locked.

The automatic belt retractors on the front seats and side rear seats¹⁾ are fitted with seat belt tensioners »» page 66.

Releasing the seat belt

- Press the red button on the belt buckle »» **Fig. 79 B.** The latch plate is released and springs out »» .
- Guide the belt back by hand so that it rolls up easily and the trim is not damaged.

Positioning seat belts

Seat belts offer their maximum protection only when they are properly positioned.

WARNING

- The seat belts offer best protection only when the backrests are in an upright posi-

tion and the seat belts have been fastened properly.

- Never put the latch plate in the buckle of another seat. If you do this, the seat belt will not protect you properly and the risk of injury is increased.
- Never unbuckle a seat belt while the vehicle is in motion. If you do, you increase the risk of sustaining severe or fatal injuries.
- An incorrectly worn seat belt can cause severe injuries in the event of an accident.
- For pregnant women, the lap part of the seat belt must lie as low as possible over the pelvis, never across the stomach, and always lie flat so that no pressure is exerted on the abdomen »» **Fig. 80.**
- Always engage the retractor lock when you are securing a child seat in group 0, 0+ or 1 »» page 73.
- Read and observe the warnings »» page 63.

Seat belt tensioners

How the seat belt tensioner works

Read the additional information carefully

» page 20.

¹⁾ Depending on version/market.

The seat belts for the front seats and the side rear seats¹⁾ are equipped with belt tensioners. The belt tensioners are activated by sensors, although only in severe head-on, lateral and rear-end collisions. This retracts and tightens the seat belts, reducing the forward motion of the occupants.

The belt tensioners will not be triggered in the event of minor collisions, if the vehicle overturns, or in accidents where no major forces act on the vehicle.

Note

- If the seat belt tensioners are triggered, a fine dust is produced. This is normal and it is not an indication of fire in the vehicle.
- The relevant safety requirements must be observed when the vehicle or components of the system are scrapped. Specialised workshops are familiar with these regulations, which are also available to you.

Maintenance and disposal of belt tensioners

The belt tensioners are components of the seat belts that are installed in the seats of your vehicle. If you work on the belt tensioners or remove and install parts of the system

when performing other repair work, the seat belt may be damaged. The consequence may be that, in the event of an accident, the belt tensioners function incorrectly or may not function at all.

So that the effectiveness of the seat belt tensioner is not reduced and that removed parts do not cause any injuries or environmental pollution, regulations, which are known to the specialised workshops, must be observed.

WARNING

- Improper use or repairs not carried out by qualified mechanics increase the risk of severe or fatal injuries. The belt tensioners may fail to trigger or may trigger in the wrong circumstances.
- Never attempt to repair, adjust, remove or install parts of the belt tensioners or seat belts.
- The seat belt tensioner, seat belt and automatic retractor cannot be repaired.
- Any work on the belt tensioners and seat belts, including the removal and refitting of system parts in conjunction with other repair work, must be performed by a specialised workshop only.

- The belt tensioners will only provide protection for one accident and must be changed if they have been activated.

¹⁾ Depending on version/market.

Airbag system

Brief introduction

Why is it so important to wear a seat belt and to sit correctly?

For the inflating airbags to achieve the best protection, the seat belt must always be worn properly and the correct sitting position must be assumed.

The airbag system is not a substitute for seat belts, but it is an integral part of the vehicle's overall passive safety system. Please bear in mind that the airbag system can only work effectively when the vehicle occupants are wearing their seat belts correctly and have adjusted the head restraints properly. Therefore, it is most important to properly wear the seat belts at all times, not only because this is required by law in most countries, but also for your safety »» page 62, **Why wear a seat belt.**

The airbag inflates in a matter of seconds, so if you are not properly seated when the airbag is triggered, you may sustain fatal injuries. Therefore, it is essential that all vehicle occupants assume a correct sitting position while travelling.

Sharp braking before an accident may cause a passenger not wearing a seat belt to be

thrown forward into the area of the deploying airbag. In this case, the inflating airbag may inflict critical or fatal injuries on the occupant. This also applies to children.

Always maintain the greatest possible distance between yourself and the front airbag. This way, the front airbags can completely deploy when triggered, providing their maximum protection.

The most important factors for triggering the airbag are the type of accident, the angle of impact and the vehicle speed.

Whether or not the airbags are triggered depends primarily on the vehicle deceleration rate resulting from the collision and detected by the control unit. If the vehicle deceleration occurring during the collision and measured by the control unit remains below the specified reference values, the front, side and/or curtain airbags will not be triggered. Take into account that the visible damage in a vehicle involved in an accident, no matter how serious, is not a determining factor for the airbags to have been triggered.

WARNING

- Wearing the seat belt incorrectly or assuming an incorrect sitting position can lead to critical or fatal injuries.
- All vehicle occupants, including children, who are not properly belted can sustain critical or fatal injuries if the airbag is trig-

gered. Children up to 12 years old should always travel on the rear seat. Never transport children in the vehicle if they are not restrained or the restraint system is not appropriate for their age, size or weight.

- If you are not wearing a seat belt, or if you lean forward or to the side while travelling or assume an incorrect sitting position, there is a substantially increased risk of injury. This increased risk of injury will be further increased if you are struck by an inflating airbag.
- To reduce the risk of injury from an inflating airbag, always wear the seat belt properly »» page 62.
- Always adjust the front seats properly.

Description of airbag system

Read the additional information carefully »»  page 21.

The airbag system is not a substitute for the seat belts. The airbag system offers additional protection for the driver and passenger in combination with the seat belts.

The airbag system comprises the following modules (as per vehicle equipment):

- Electronic control unit
- Front airbags for driver and passenger
- Knee airbag for the driver

- Side airbags
- Head airbag
- Airbag control lamp  on the instrument panel »» page 73
- Key-operated switch for front passenger airbag
- Control lamp for disabled/enabled status of the front passenger airbag.

The airbag system operation is monitored electronically. The airbag control lamp will illuminate for a few seconds every time the ignition is switched on (self-diagnosis).

There is a fault in the system if the control lamp :

- does not light up when the ignition is switched on »» page 73,
- turns off after 4 seconds after the ignition is switched on,
- turns off and then lights up again after the ignition is switched on,
- illuminates or flashes while the vehicle is moving.

The airbag system is not triggered if:

- the ignition is switched off
- there is a minor frontal collision
- there is a minor side collision
- there is a rear-end collision

- the vehicle turns over.

WARNING

- **The seat belts and airbags can only provide maximum protection if the occupants are seated correctly »» page 57, Correct position of the vehicle occupants.**
- **If a fault has occurred in the airbag system, have the system checked immediately by a specialised workshop. Otherwise there is a danger that during a collision, the system may fail to trigger, or not trigger correctly.**

Airbag activation

The airbags deploy extremely rapidly, within thousandths of a second, to provide additional protection in the event of an accident. A fine dust may develop when the airbag deploys. This is normal and it is not an indication of fire in the vehicle.

The airbag system is only ready to function when the ignition is on.

In special accidents instances, several airbags may activate at the same time.

In the event of minor head-on and side collisions, rear-end collisions, overturning or roll-over of the vehicle, airbags **do not activate**.

Activation factors

The conditions that lead to the airbag system activating in each situation cannot be generalised. Some factors play an important role, such as the properties of the object the vehicle hits (hard/soft), angle of impact, vehicle speed, etc.

Deceleration trajectory is key for airbag activation.

The control unit analyses the collision trajectory and activates the respective restraint system.

If the deceleration rate is below the predefined reference value in the control unit the airbags will not be triggered, even though the accident may cause extensive damage to the car.

The following airbags are triggered in serious head-on collisions:

- Driver airbag.
- Front passenger front airbag
- Knee airbag for the driver.

The following airbags are triggered in serious side-on collisions:

- Front side airbag on the side of the accident.
- Curtain (head) airbag on the side of the accident. »

In an accident with airbag activation:

- the interior lights switch on (if the interior light switch is in the courtesy light position);
- the hazard warning lights switch on;
- all doors are unlocked;
- the fuel supply to the engine is cut.

Airbag safety instructions

Front airbags

Read the additional information carefully
 >>>  page 21.

 WARNING

- The deployment space between the front passengers and the airbags must not in any case be occupied by other passenger, pets and objects.
- The airbags provide protection for just one accident; replace them once they have deployed.
- It is also important not to attach any objects such as cup holders or telephone mountings to the surfaces covering the airbag units.
- Do not attempt to modify components of the airbag system in any way.

Knee airbag*

Read the additional information carefully
 >>>  page 23.

 WARNING

- The knee airbag is deployed in front of the driver's knees. Always keep the deployment areas of the knee airbags free.
- Never not fix objects to the cover or in the deployment area of the knee airbag.
- Adjust the driver's seat so that there is a distance of at least 10 cm (4 inches) between your knees and the location of the this airbag. If your physical constitution prevents you from meeting these requirements, make sure you contact a specialised workshop.

Side airbags

Read the additional information carefully
 >>>  page 23.

 WARNING

- If you do not wear a seat belt, if you lean forward, or are not seated correctly while the vehicle is in motion, you are at a greater risk of injury if the side airbag system is triggered in an accident.
- In order for the side airbags to provide their maximum protection, the prescribed

sitting position must always be maintained with seat belts fastened while travelling.

- In a side-on collision the side airbags will not work if the sensors do not correctly measure the pressure increase on the interior of the doors, due to air escaping through the areas with holes or openings in the door panel.
- Never drive if the interior door panels have been removed or if the panels have not been correctly fitted.
- Never drive the vehicle if the loudspeakers in the door panels have been removed, unless the holes left by the loudspeakers have been closed properly.
- Always check that the openings are closed or covered if loudspeakers or other equipment are fitted inside the door panels.
- Occupants of the outer seats must never carry any objects or pets in the deployment space between them and the airbags, or allow children or other passengers to travel in this position. It is also important not to attach any accessories (such as cup holders) to the doors. This would impair the protection offered by the side airbags.
- The built-in coat hooks should be used only for lightweight clothing. Do not leave any heavy or sharp-edged objects in the pockets.

- Great forces, such as hard blows or kicks, must not be exerted upon the backrest bolster because the system may be damaged. In this case, the side airbags would not be triggered.
- Under no circumstances should protective covers be fitted over seats with side airbags unless the covers have been approved for use in your vehicle. Because the airbag deploys from the side of the backrest, the use of conventional seat covers would obstruct the side airbag, seriously reducing the airbag's effectiveness.
- Any damage to the original seat upholstery or around the seams of the side airbag units must be repaired immediately by a specialised workshop.
- The airbags provide protection for just one accident; replace them once they have deployed.
- Any work on the side airbag system or removal and installation of the airbag components for other repairs (such as removal of the front seat) should only be performed by a specialised workshop. Otherwise, faults may occur during the airbag system operation.
- Do not attempt to modify components of the airbag system in any way.

Curtain airbags*

Read the additional information carefully

>>>  page 24.

WARNING

- In order for the head-protection airbags to provide their maximum protection, the prescribed sitting position must always be maintained with seat belts fastened while travelling.
- For safety reasons, the curtain airbag must be disabled in those vehicles fitted with a screen dividing the interior of the vehicle. See your technical service to make this adjustment.
- There must be no other persons, animals or objects between the occupants of the outer seats and the deployment space of the head-protection airbags so that the head-protection airbag can deploy completely without restriction and provide the greatest possible protection. Therefore, sun blinds which have not been expressly approved for use in your vehicle may not be attached to the side windows
- The built-in coat hooks should be used only for lightweight clothing. Do not leave any heavy or sharp-edged objects in the pockets. Please, do not hang the clothes on coat hangers.
- The airbags provide protection for just one accident; replace them once they have deployed.

- Any work on the head-protection airbag system or removal and installation of the airbag components for other repairs (such as removal of the roof lining) should only be performed by a specialised workshop. Otherwise, faults may occur during the airbag system operation.
- Do not attempt to modify components of the airbag system in any way.
- The side and head airbags are managed through sensors located in the interior of the front doors. To ensure the correct operation of the side and curtain airbags neither the doors nor the door panels should be modified in any way (e.g. fitting loudspeakers). If the front door is damaged, the airbag system may not work correctly. All work carried out on the front door must be done in a specialised workshop.

Deactivating airbags

Activation and deactivation of front passenger airbag



Fig. 81 Switch for activating and deactivating the front passenger airbag.



Fig. 82 Dashboard: control lamp for deactivated front passenger airbag in centre console.



Deactivate the front passenger front airbag only if you have to use a rear-facing child seat in the front passenger seat.

CUPRA recommends fitting the child seat in the rear seat to avoid having to deactivate the front passenger airbag.



Front passenger front airbag switch

When the front passenger airbag is **deactivated**, this means that only the front passenger front airbag is deactivated. All the other airbags in the vehicle remain activated.

Disconnect the front passenger front airbag

- Switch the ignition off.
- Open the door on the front passenger side.
- Insert the key into the slot of the switch for deactivating the front passenger airbag >>> **Fig. 81**. About 3/4 of the key should enter; this is as far as it will go.
- Turn the key gently to the **OFF** position. If you have difficulty, ensure that you have inserted the key as far as it will go.
- Close the front passenger door.
- Check, with the ignition switched on, that the **OFF**  control lamp remains lit where it says **PASSENGER AIR BAG OFF** , in the centre of the dash panel >>> **Fig. 82**.

Connect the front passenger front airbag

- Switch the ignition off.
- Open the front passenger door.
- Insert the key into the slot of the switch for deactivating the front passenger airbag >>> **Fig. 81**. About 3/4 of the key should enter, as far as it will go.
- Turn the key gently to the **ON** position. If you have difficulty, ensure that you have inserted the key as far as it will go.
- Close the front passenger door.
- Check, with the ignition switched on, that the **OFF**  control lamp is not lit where it says **PASSENGER AIR BAG OFF** , in the centre of the dash panel >>> **Fig. 82**. The **ON**  control lamp lights up for 60 seconds and then goes off.

WARNING

- The driver of the vehicle is responsible for disabling or switching on the airbag.
- Always switch off the ignition before disabling the front passenger airbag! Failure to do so could result in a fault in the airbag deactivation system.
- Never leave the key in the airbag disabling switch as it could get damaged or enable or disable the airbag during driving.
- If for any reason an airbag is deactivated, reactivate it as soon as possible so that it can fulfil its protective function.

Airbag system control lamps



It lights up on the combi-instrument

Fault in airbag system and seat belt tensioners.
Have the system checked immediately by a specialised workshop.



It lights up on the dash panel



Front passenger front airbag disabled.
Check whether the airbag should remain disabled







It lights up on the dash panel

Front passenger airbag enabled.
The control lamp switches off automatically 60 seconds after the ignition is switched on

Several warning and control lamps light up for a few seconds when the ignition is switched on, signalling that the function is being verified. They will switch off after a few seconds.

If the airbag and seat belt tensioner system control lamp  remains on or flashes, it indicates a malfunction in the airbag and seat belt tensioner system >>> . Have the system checked immediately by a specialised workshop.

If the front passenger airbag is deactivated, the warning lamp **PASSENGER AIR BAG OFF**  remains lit on the dash panel to remind you that the airbag is deactivated. If, with the

front passenger airbag deactivated, this lamp does not remain lit or if it is lit together with the control lamp  on the dash panel, there is a fault in the airbag system >>> . If the control lamp is flashing, there is a fault in the disabling of the airbag system >>> . Have the system checked immediately by a specialised workshop.

WARNING

In the event of a fault in the airbag and seat belt tensioner system, the airbags and seat belts may not trigger correctly, may fail to trigger or may even trigger unexpectedly.

- **The vehicle occupants run the risk of sustaining severe or fatal injuries. Have the system checked immediately by a specialised workshop.**
- **Do not mount a child seat in the front passenger seat or remove the mounted child seat! The front passenger front airbag may deploy during an accident in spite of the fault.**

CAUTION

Always pay attention to any lit control lamps and to the corresponding descriptions and instructions to avoid damage to the vehicle or harm to the occupants.

Transporting children safely

Safety for children

Introduction

For safety reasons, as we have learned from accident statistics, we recommend that children under 12 years of age travel in the rear seats. Depending on their age, height and weight, children travelling in rear seats must use a child seat or a seat belt. For safety reasons, the child seat should be installed in the rear seat, behind the front passenger seat or in the centre back seat.

The physical laws involved and the forces acting in a collision apply also to children >>> page 64. But unlike adults, children do not have fully developed muscle and bone structures. This means that children are subject to a greater risk of injury.

To reduce the risk of injuries, children must always use special child restraint systems when travelling in the vehicle.

We recommend the use of child safety products from the Original Accessories Programme, which includes systems for all ages made by "Peke" (not for all countries) (see www.seat.com).

»

These systems have been especially designed and approved, complying with the ECE-R44. regulation.

CUPRA recommends securing the child seats shown on the website as described below:

- Child seats in the opposite direction of travel (group 0+): ISOFIX and support bracket (Peke GO Plus + ISOFIX Base (RWF)).
- Child seats in the direction of travel (group 1): ISOFIX and Top Tether (Peke G1 ISOFIX DUO Plus).
- Child seats directed towards the front of the vehicle for group 2: safety belt and ISOFIX (Peke G3 KIDFIX)¹⁾.
- Child seats directed towards the front of the vehicle for group 3: safety belt and ISOFIX (Peke G3 KIDFIX)¹⁾.

Follow the manufacturer's instructions and observe any statutory requirements when installing and using child seats. Always read and note >>> page 74.

We recommend you always carry the manufacturer's Child Seat Instruction Manual together with the on-board documentation.

¹⁾ Temporarily, the child seat recommended by the Accessories Programme for groups 2 and 3 will be ROMER KIDFIX XP[®] instead of Peke G3 KIDFIX. It is available from the CUPRA website.

Important information regarding the front passenger's airbag

Read the additional information carefully >>>  page 24.

Read and always observe the safety information included in the following chapters:

- Safety distance with respect to the passenger airbag >>> page 68.
- Objects between the passenger and the passenger side airbag >>>  in Front airbags on page 70.

The passenger side front airbag, when enabled, is a serious risk for a child that is facing backward since the airbag can strike the seat with such force that it can cause serious or fatal injuries. Children up to 12 years old should always travel on the rear seat.

Therefore we strongly recommend you to transport children on the rear seats. This is the safest location in the vehicle. Alternatively, the front passenger airbag can be disabled with a key-operated switch >>> page 72. When transporting children, use a child seat

suitable for the age and size of each child >>> page 75.

WARNING

- If a child seat is secured to the front passenger seat, the risk to the child of sustaining critical or fatal injuries in the event of an accident increases.
- An inflating front passenger airbag can strike the rear-facing child seat and project it with great force against the door, the roof or the backrest.
- Never install a child seat facing backwards on the front passenger seat unless the front passenger front airbag has been disabled. Risk of potentially fatal injuries to the child! However, if it is necessary, in exceptional cases, to transport a child in the front passenger seat, the front passenger front airbag must always be disabled >>> page 72. If the passenger seat has a height adjustment option, move it to the highest, most upright position. If you have a fixed seat, do not install any child restraint system in this location.
- For those vehicles that do not include a key lock switch to deactivate the airbag, the vehicle must be taken to a technical service. Do not forget to reconnect the airbag

when an adult wants to sit in the front passenger seat.

- All vehicle occupants, especially children, must assume the proper sitting position and be properly belted in while travelling.
- Never hold children or babies on your lap, this can result in potentially fatal injuries to the child!
- Never allow a child to be transported in a vehicle without being properly secured, or to stand up or kneel on a seat while travelling. In an accident, the child could be flung through the vehicle, causing possibly fatal injuries to themselves and to the other vehicle occupants.
- If children assume an improper sitting position when the vehicle is moving, they expose themselves to greater risk of injury in the event of a sudden braking manoeuvre or in an accident. This is particularly important if the child is travelling on the front passenger seat and the airbag system is triggered in an accident; as this could cause serious injury or even death.
- A suitable child seat can protect your child!
- Never leave a child alone in the child seat or inside the vehicle because depending on the season, very high temperatures may be reached inside a parked vehicle, which could be fatal.
- Children who are less than 1.5 metres tall must not wear a normal seat belt without a

child seat, as this could cause injuries to the abdominal and neck areas during a sudden braking manoeuvre or in an accident.

- Do not allow the seat belt to become twisted and the seat belt should be properly in place >>> page 62.
- Only one child may occupy a child seat >>> page 75, Child seats.
- When a child seat is mounted in the rear seats, the door child-proof lock should be activated >>> page 121.

Child seats

Safety instructions

Read the additional information carefully >>>  page 24.

WARNING

When travelling, children must be secured in the vehicle with a restraint system suitable for age, weight and size.

- Read and always observe information and warnings concerning the use of child seats >>> page 74.

WARNING

The retaining rings are designed only for use with "ISOFIX" and Top Tether* system child seats.

- Never secure other child seats that do not have the "ISOFIX" or Top Tether* system, or retaining belts or objects to the fastening rings - this can result in potentially fatal injuries to the child.
- Ensure that the child seat is secured correctly using the "ISOFIX" and Top Tether* securing rings.

WARNING

An undue installation of the safety seat will increase the risk of injury in the event of a crash.

- Never tie the retainer strap to a hook in the luggage compartment.
- Never secure or tie luggage or other items to the lower anchorages (ISOFIX) or the upper ones (Top Tether).

Categorisation of child seats into groups

Use only child seats that are officially approved and suitable for the child.

Child seats are subject to the regulation ECE-R 44 or ECE-R 129. ECE-R stands for: »

Economic Commission for Europe Regulation.

The child seats are grouped into 5 categories:

Group 0 Up to 10 kg (up to around 9 months)

Group 0+ Up to 13 kg (up to around 18 months)

Group 1 from 9 to 18 kg (up to approx. 4 years old)

Group 2 from 15 to 25 kg (up to approx. 7 years old)

Group 3 from 22 to 36 kg (up to approx. 7 years old)

Child seats that have been tested and approved under the ECE-R 44 or ECE-R 129 standard bear the test mark ECE-R 44 or ECE-R 129 on the seat (the letter E in a circle with the test number below it).

Follow the manufacturer's instructions and observe any statutory requirements when installing and using child seats.

We recommend you to always include the manufacturer's Child Seat Instruction Manual together with the on-board documentation.

CUPRA recommends you use child seats from the **Original Accessories Catalogue**. These child seats have been designed and

tested for use in our vehicles. You can find the right child seat for your model and age group at our dealers.

Child seats by approval category

Child seats may have the approval category of universal, semi-universal, vehicle specific (all according to the ECE-R 44 standard) or i-Size (according to the ECE-R 129 standard).

- **Universal:** child seats with universal approval can be installed in all vehicles. There is no need to consult any list of models. In the case of universal approval for ISOFIX, the child seat is additionally provided with a Top Tether belt.
- **Semi-universal:** semi-universal approval, in addition to the standard requirements of universal approval, requires safety devices to lock the child seat, which require additional testing. Child seats with semi-universal approval include a list of vehicle models for which they can be installed.
- **Vehicle-specific:** vehicle-specific approval requires a dynamic test of the child seat for each vehicle model separately. Child seats with vehicle-specific approval also include a list of vehicle models for which they can be installed.
- **i-Size:** child seats with i-Size approval must meet the requirements prescribed in the ECE-R 129 standard in relation to installation and safety. Child seat manufacturers can tell

you which seats have i-Size approval for this vehicle.

Attachment systems

Depending on the country, different attachment systems are used for safely installing child seats.

Attachment systems overview

• **ISOFIX:** ISOFIX is a standardised attachment system allowing quick and safe attachment of child seats in the vehicle. ISOFIX attachment establishes a rigid connection between the child seat and the car body.

The child seat has two rigid attachment clips, called connectors. These connectors are fitted into the ISOFIX attachment rings found between the seat cushion and the backrest of the vehicle's back seat (on the sides). ISOFIX attachment systems are used mainly in Europe >>>  page 26. If necessary, ISOFIX attachment may have to be supplemented with a Top Tether belt or a support bracket.

• **Automatic three-point seat belt.** Whenever possible, it is preferable to attach the child seats with the ISOFIX system rather than attaching them with an automatic three-point seat belt >>>  page 25.

Additional attachment:

- **Top Tether:** the Top Tether belt is guided over the back of the rear seat and attached to an anchor point with a hook. Anchor points are located at the back of the rear seat backrest on the boot side >>>  page 29. The rings for retaining the Top Tether belt are marked with an anchor symbol.

- **Support bracket:** some child seats rest on the floor of the vehicle with a support bracket. The support bracket prevents the child seat from tipping forward in the event of impact. Child seats fitted with a support bracket should only be used in the passenger seat and side rear seats >>> . For the assembly of this type of seat you should also consult the list of approved vehicles for this assembly, available in the instructions for child restraint systems.

Recommended systems for attaching child seats

CUPRA recommends attaching child seats as follows:

- **Baby carriers or child seats in the opposite direction of travel:** ISOFIX and support bracket or iSize.
- **Child seats in the direction of travel:** ISOFIX and Top Tether.

WARNING

Incorrect use of the support bracket can cause serious or fatal injury.

- Make sure the support bracket is correctly and safely installed.

Emergencies

Self-help

Vehicle tool kit, anti-puncture kit*

The tools and anti-puncture kit* are stored under the floor panel in the luggage compartment.

To access the vehicle tools:

- Lift up the floor surface by the plastic handle until it is fastened to the tabs on both sides.

Depending on the vehicle equipment, the anti-puncture kit* is located under the floor panel in the luggage compartment.

The tool kit includes:

- Jack*
- Wire hook for pulling off the wheel cover*/wheel bolt cap clip.
- Box spanner for wheel bolts*
- Towline anchorage
- Adapter for the anti-theft wheel bolts*
- Towing bracket device

Some of the items listed are only provided in certain model versions, or are optional extras.

Note

The jack does not generally require any maintenance. If required, it should be greased using universal type grease.

Tyre repair

TMS (Tyre Mobility System)*

Read the additional information carefully
 >>>  page 47

The Anti-puncture kit* (Tyre Mobility System) will reliably seal punctures caused by the penetration of a foreign body of up to about **4 mm** in diameter. **Do not remove foreign objects, e.g. screws or nails, from the tyre.**

After inserting the sealant residue in the tyre, you must again check the tyre pressure about 10 minutes after starting the engine.

You should only use the tyre mobility set if the vehicle is parked in a safe place, you are familiar with the procedure and you have the necessary tyre mobility set! Otherwise, you should seek professional assistance.

Do not use the tyre sealant in the following cases:

- If the wheel rim has been damaged.

- In outside temperatures below -20°C (-4°F).
- In the event of cuts or perforations in the tyre greater than 4 mm.
- If you have been driving with very low pressure or a completely flat tyre.
- If the sealant bottle has passed its use by date.

WARNING

Using the tyre mobility system can be dangerous, especially when filling the tyre at the roadside. Please observe the following rules to minimise the risk of injury:

- Stop the vehicle safely as soon as possible. Park it at a safe distance from surrounding traffic to fill the tyre.
- Ensure the ground on which you park is flat and solid.
- All passengers and particularly children must keep a safe distance from the work area.
- Turn on the hazard warning lights to warn other road users.
- Use the tyre mobility system only if you are familiar with the necessary procedures. Otherwise, you should seek professional assistance.
- The tyre mobility set is intended for temporary emergency use only until you can reach the nearest specialised workshop.

- Replace the repaired tyre with the tyre mobility set as soon as possible.
- The sealant is a health hazard and must be cleaned immediately if it comes into contact with the skin.
- Always keep the tyre mobility set out of the reach of small children.
- Always switch off the engine, activate the electronic parking brake and place the selector lever in P to reduce the risk of accidental vehicle movement.

⚠ WARNING

A tyre filled with sealant does not have the same performance properties as a conventional tyre.

- Never drive faster than 80 km/h (50 mph).
- Avoid heavy acceleration, hard braking and fast cornering.
- Drive for only 10 minutes at a maximum speed of 80 km/h (50 mph) and then check the tyre.

♻ For the sake of the environment

Dispose of used or expired sealant observing any legal requirements.

i Note

You can purchase a new bottle of tyre sealant in specialised CUPRA dealers or any SEAT dealership.

i Note

Take into account the separate instruction manual of the tyre mobility set* manufacturer.

Contents of the tyre mobility system*

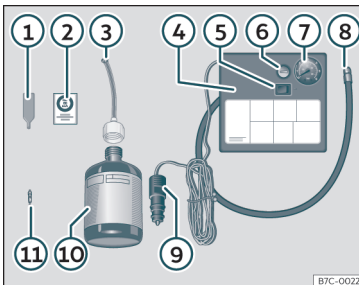

Fig. 83 Standard display: contents of the anti-puncture kit.

The anti-puncture kit is located underneath the floor covering in the luggage compartment. It includes the following components >>> **Fig. 83:**

- ① Valve insert remover
- ② Sticker indicating maximum speed “max. 80 km/h” or “max. 50 mph”
- ③ Filler tube with cap
- ④ Air compressor
- ⑤ ON/OFF switch
- ⑥ Air bleed screw (it can also be integrated in the inflator tube).
- ⑦ Warning provided by tyre pressure monitoring system (it can also be integrated in the inflator tube).
- ⑧ Tube for inflating tyres
- ⑨ 12 volt connector
- ⑩ Bottle of sealant
- ⑪ Spare tyre valve

The **valve insert remover** ① has a gap at the lower end for a valve insert. The valve insert can only be screwed or unscrewed in this way. This also applies to its replacement part ⑪.

⚠ WARNING

When inflating the wheel, the air compressor and the inflator tube may become hot.

- Protect hands and skin from hot parts.
- Do not place the hot flexible inflator tube or hot air compressor on flammable material.

- Allow them to cool before storing the device.
- If it is not possible to inflate the tyre to at least 2.0 bars (29 psi / 200 kPa), the tyre is too badly damaged. The sealant is not in a good condition to seal the tyre. Do not continue driving. Seek specialist assistance.

ⓘ CAUTION

Switch off the air compressor after a maximum of 8 operational minutes to avoid overheating! Before switching on the air compressor again, let it cool for several minutes.

Check after 10 minutes of driving

Screw in the inflator tube >>> Fig. 83 ⑧ again and check the pressure on the gauge ⑦.

1.3 bar (19 psi / 130 kPa) and lower:

- **Stop the vehicle!** The tyre cannot be sealed sufficiently with the tyre mobility set.
- You should obtain professional assistance >>> ⚠.

1.4 bar (20 psi / 140 kPa) and higher:

- Set the tyre pressure to the correct value again.

- Carefully resume your journey until you reach the nearest specialised workshop without exceeding 80 km/h (50 mph).
- Have the damaged tyre replaced.

⚠ WARNING

Driving with an unsealed tyre is dangerous and can cause accidents and serious injury.

- Do not continue driving if the tyre pressure is 1.3 bar (19 psi / 130 kPa) and lower.
- Seek specialist assistance.

Manual unlocking/locking

Introduction

Read the additional information carefully >>> 📖 page 16, >>> 📖 page 17.

The doors, rear lid and panoramic tilting sun-roof can be locked manually and partially opened, for example if the key or the central locking is damaged.

⚠ WARNING

Opening and closing doors carelessly can cause serious injury.

- If the vehicle is locked from outside, the doors and windows cannot be opened from the inside.

- Never leave children or disabled people alone in the car. They could be trapped in the car in an emergency and will not be able to get themselves to safety.
- Depending on the time of the year, temperatures inside a locked and closed vehicle can be extremely high or extremely low resulting in serious injuries and illness or even death, particularly for young children.

⚠ WARNING

Getting in the way of the doors and the rear lid is dangerous and can lead to serious injury.

- Open and close the doors and the rear lid only when there is nobody in the way.

ⓘ CAUTION

When opening and closing in an emergency, carefully disassemble components and then reassemble them carefully to avoid damage to the vehicle.

Changing the windscreen wiper blades

Changing the windscreen and rear window wiper blades

Read the additional information carefully
 >>>  page 54.

The windscreen wiper blades are supplied as standard with a layer of graphite. This layer is responsible for ensuring that the wipe is silent. If the graphite layer is damaged, the noise of the water as it is wiped across the windscreen will be louder.

Check the condition of the wiper blades regularly. **If the wipers scrape across the glass**, they should be changed if they are damaged, or cleaned if they are dirty >>> .

Damaged windscreen wiper blades should be replaced immediately. These are available from qualified workshops.

WARNING

Worn or dirty windscreen wiper blades reduce visibility and increase the risk of accident and serious injury.

- Always replace damaged or worn windscreen wiper blades or blades that no longer clean the windscreen properly.

CAUTION

- Damaged or dirty windscreen wipers could scratch the glass.
- If products containing solvents, rough sponges or sharp objects are used to clean the blades, the graphite layer will be damaged.
- Never use fuel, nail varnish remover, paint thinner or similar products to clean the windows.
- In icy conditions, always check that the wiper blades are not frozen to the glass before using the wipers. In cold weather, it may help to leave the vehicle parked with the wipers in service position
 >>>  page 54.

CAUTION

- To prevent damage to the bonnet and the wiper arms, only leave them in the service position.
- Before driving, always lower the wiper arms.

Tow-starting and towing

Introduction

Tow-starting means starting the engine of the vehicle while another pulls it.

Towing means one vehicle pulling another that is not roadworthy.

Always consider the legal provisions relating to tow-starting and towing.

For technical reasons, towing a vehicle with a discharged battery is not allowed.

The jump start should be used instead
 >>>  page 52.

If the vehicle comes with the Keyless Access system, towing is only allowed with the ignition on!

The vehicle battery drains if the vehicle is towed with the engine switched off and the ignition connected. Depending on the battery charge status, the drop in voltage may be so large, even after just a few minutes, that no electrical device in the vehicle may work e.g. the hazard warning lights. In vehicles with the Keyless Access system, the steering wheel could lock >>> .

WARNING

A vehicle with no power should never be towed.

- During towing, never switch off the ignition with the starter button. Otherwise, the electronic lock of the steering column could suddenly get blocked and it would be impossible to steer the vehicle. This could cause an accident, serious injury and loss of control of the vehicle. >>>

- If during towing the vehicle runs out of power, stop towing immediately and request the assistance of specialist personnel.

WARNING

Vehicle handling and braking capacity change considerably during towing. Please observe the following instructions to minimise the risk of serious accidents and injury:

- As the driver of the vehicle being towed:
 - You should depress the brake much harder as the brake servo does not operate. Pay the utmost attention to avoid crashing into the towing vehicle.
 - More strength is required at the steering wheel as the power steering does not operate when the engine is switched off.
- As the driver of the towing vehicle:
 - Accelerate with particular care and caution.
 - Avoid sudden braking and manoeuvres.
 - Brake earlier than usual and more smoothly.

CAUTION

- To avoid damaging the vehicle, for example the paint, remove and replace the lid and towing eye carefully.

- Unburnt fuel could enter the catalytic converter and damage it during towing.

Indications for tow-starting

Vehicle's should not generally be tow-started. The jump start should be used instead >>>  page 52.

For technical reasons, towing the following vehicles is **not** allowed:

- Vehicles with an automatic gearbox.
- If the vehicle battery is discharged, because in vehicles with the Keyless Access locking and ignition system the steering remains locked and the electronic parking brake cannot be deactivated nor can the electronic lock of the steering column be released if they are activated.
- If the battery is flat, it is possible that the engine control units may not operate correctly.

CAUTION

When tow-starting, unburnt fuel could enter the catalytic converter and damage it.

Note

The vehicle can only be tow-started if the electronic parking brake and, if appropriate, the electronic lock of the steering col-

umn are deactivated. If the vehicle has no power supply or there is an electric system fault, the engine must be tow-started to deactivate the electronic parking brake and the electronic lock of the steering column.

Towing instructions

Tow rope or tow bar

It is safer for the vehicle to be towed using a tow bar, avoiding damage to the vehicle. A tow rope should only be used if a tow bar is not available.

A tow rope should be slightly elastic to avoid damage to both vehicles. It is advisable to use a tow rope made of synthetic fibre or similarly elastic material.

Only attach the tow rope or the tow bar to the towing eyes provided or a towing bracket.

If the vehicle is **factory-equipped with a towing bracket**, it is **only** allowed to tow with a tow bar if this has been specially designed to be installed with a tow hitch >>> page 299.

When the vehicle has to be towed:

Check whether the vehicle may be towed >>> page 83, Cases where towing a vehicle is not allowed.

- Switch the ignition on.

- Move the selector lever to the N >>> page 224 position.
- Do not allow the vehicle to be towed at speeds of over 50 km/h (30 mph).
- The vehicle must not be towed further than 50 km (30 miles).
- If a breakdown lorry is used, vehicles with automatic transmission are only allowed to be towed with the front wheels suspended.

Towing vehicles with four-wheel drive (4Drive)

Four-wheel drive vehicles (4Drive) can be towed using a tow bar or tow rope. If the vehicle is towed with the front or rear axle suspended, the engine must be switched off, otherwise the transmission may be damaged.

Cases where towing a vehicle is not allowed

- If, due to a fault, the gearbox is out of lubricant.
- If the vehicle battery is discharged, because the steering remains locked and, if appropriate, the electronic parking brake cannot be deactivated or the electronic lock of the steering column released.
- If a distance above 50 km needs to be travelled.

- When, for example, after an accident, the smooth rotation of the wheels or the steering operation cannot be guaranteed.

When the vehicle is to tow another vehicle:

- Observe legal requirements.
- Keep in mind the instructions in the manual on towing vehicles.

Note

The vehicle can only be towed if the electronic parking brake and the electronic lock of the steering column are deactivated. If the vehicle has no power supply or there is an electric system fault, the engine must be tow-started >>>  page 52 to deactivate the electronic parking brake and the electronic lock of the steering column.

Fitting the front towing eye

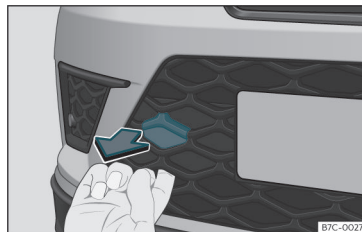

Fig. 84 Front bumper on right: remove the lid.



Fig. 85 Right side of the front bumper: towline anchorage screwed in.

The housing of the screw towing eye is on the right side of the front bumper behind a lid >>> Fig. 84.

The towing eye should always be kept in the vehicle. >>>

Bear in mind the instructions for towing
»» page 82.

Fitting the towline anchorage

- Remove the towing eye from the vehicle tool kit in the luggage compartment
»» page 78.
- Remove the lid of the towing eye by inserting a finger in the grid hole and pressing outward »» Fig. 84.
- Remove the lid and let it hang from the vehicle.
- Screw the towing eye in the housing by turning it to the maximum **anticlockwise** »» ❶. Use a suitable object that can completely and securely tighten the towing eye in its housing.
- After towing, unscrew the towing eye **clockwise** with a suitable object.
- Insert the bottom flange of the lid into its housing and press the upper side of the lid until it is inserted into the bumper.
- Replace the lid by inserting the bottom part first and pressing until it fits into the bumper.
- Clean the towing eye if necessary and then store it in the luggage compartment along with the other vehicle tools.

❶ CAUTION

The towing eye must always be completely and firmly tightened. Otherwise, it could be released while towing and tow-starting.

Fitting the rear towing eye

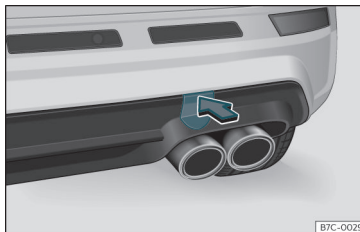

Fig. 86 Rear bumper on right: remove the lid.

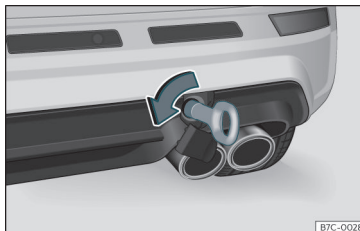

Fig. 87 Right side of the rear bumper: towline anchorage screwed in.

The housing of the screw towing eye is on the right side of the rear bumper behind a lid »» Fig. 86. Vehicles equipped as standard with a towing bracket **do not** have any housing for the screw towing eye behind the lid. In this case, the tow hitch needs to be extracted or installed and used for towing
»» page 296, »» ❶.

Bear in mind the instructions for towing
»» page 82.

Assemble the rear towing eye (cars without a factory-equipped towing bracket)

- Remove the towing eye from the vehicle tool kit in the luggage compartment
»» page 78.
- Press the upper side of the lid »» Fig. 86 to unclip it.
- Remove the lid and let it hang from the vehicle.
- Screw the towing eye in the housing by turning it to the maximum **anticlockwise** »» Fig. 87 »» ❶. Use a suitable object that can completely and securely tighten the towing eye in its housing.
- After towing, unscrew the towing eye **clockwise** with a suitable object.
- Insert the upper flange of the lid into the opening of the bumper and press the lower side of the lid until it is inserted into the bumper.

- Clean the towing eye if necessary and then store it in the luggage compartment along with the other vehicle tools.

ⓘ CAUTION

- The towing eye must always be completely and firmly tightened. Otherwise, it could be released while towing and tow-starting.
- If the vehicle is factory-equipped with a towing bracket, it is only allowed to tow with a tow bar if this has been specially designed to be installed with a tow hitch. If an unsuitable tow bar is used, both the tow hitch and the vehicle may be damaged. Instead, a tow rope should be used.

Driving tips for towing

Towing requires some expertise and experience, especially when using a tow rope. Both drivers should be familiar with the difficulties involved in towing. For this reason, inexperienced drivers should abstain from towing.

During towing, it should be ensured that no impermissible tractive forces or shocks are generated. When towing on an unpaved road, there is always a risk of overloading and damaging the anchorage points.

During towing, the towing vehicle can signal the change of direction even with the hazard warning lights turned on. To do so, at the same time, the turn signal lever must be op-

erated with ignition switched on. Meanwhile, the hazard warning lights will go off. When the turn signal lever is returned to the rest position, the hazard warning lights will be automatically reactivated.

Notes for the driver of the towed vehicle

- Leave the ignition on, so that the steering is not blocked, and the electronic parking brake may be deactivated and the turn signals and wash/wipe operated.
- More strength is required at the steering wheel as the power steering does not operate when the engine is switched off.
- You should depress the brake much harder as the brake servo does not operate. Avoid hitting the towing vehicle.
- Bear in mind the information and instructions in the manual of the vehicle to be towed.

Notes for the driver of the towing vehicle

- Accelerate with particular care and caution. Avoid sharp manoeuvres.
- Brake earlier than usual and smoothly.
- Bear in mind the information and instructions in the manual of the towed vehicle.

Fuses and bulbs

Fuses

Introduction

In general, a fuse can be assigned to various electrical components. Likewise, an electrical component can be protected by several fuses.

Only replace fuses when the cause of the problem has been solved. If a newly inserted fuse blows after a short time, you must have the electrical system checked by a specialised workshop as soon as possible.

⚠ WARNING

The high voltages in the electrical system can give serious electrical shocks, causing burns and even death!

- Never touch the electrical wiring of the ignition system.
- Take care not to cause short circuits in the electrical system.

⚠ WARNING

Using unsuitable fuses, repairing fuses or bridging a current circuit without fuses can cause a fire and serious injury.

- Never use a fuse with a higher value. Only replace fuses with a fuse of the same »

amperage (same colour and markings) and size.

- Never repair a fuse.
- Never replace a fuse by a metal strip, staple or similar.

ⓘ CAUTION

- To prevent damage to the vehicle's electric system, before replacing a fuse always turn off the ignition, the lights and all electrical elements and remove the key from the ignition.
- If you replace a fuse with higher-rating fuse, you could cause damage to another part of the electrical system.
- Protect the fuse boxes when open to prevent the entry of dust or humidity as they can damage the electrical system.

ⓘ Note

- One component may have more than one fuse.
- Several components may run on a single fuse.

Vehicle interior fuses

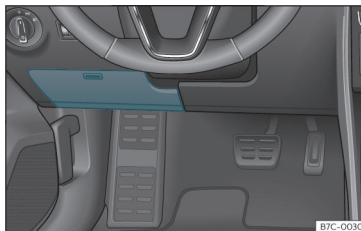

Fig. 88 Vehicles with the steering wheel on the left: fuse box cover under the driver-side dash panel

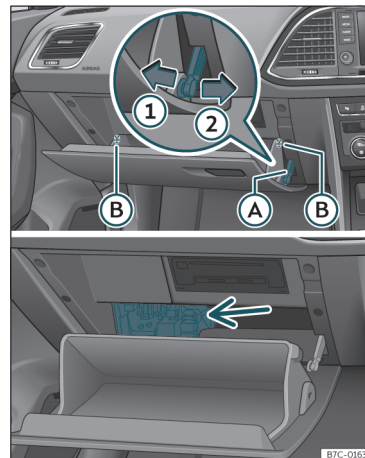

Fig. 89 Vehicles with the steering wheel on the right: access the fuse box behind the glove compartment.

Opening and closing the fuse box situated below the dash panel (left-hand steering wheel)

- *Open*: fold the cover down >>> **Fig. 88**.
- *Close*: push back the cover it in until it clicks into place.

Fuses behind the glove compartment (right-hand steering wheel)

To be able to access the fuse box:

- Undo the opening limiter >>> **Fig. 89** **(A)** in two steps: first, unlock the limiter by pulling back on it (arrow **①**) and then move it gently to the right (arrow **②**). Remove the guide when the cover is in the normal opening position (30°).
- Free the side pivots **(B)** to release the cover to its second opening position (60°).

Follow the same procedure in reverse order to return the glove compartment to its normal position.

ⓘ CAUTION

- Always carefully remove the fuse box covers and refit them correctly to avoid problems with your vehicle.
- Protect the fuse boxes when open to avoid the entry of dust or humidity. Dirt and humidity inside fuse boxes can cause damage to the electrical system.

Engine compartment fuses

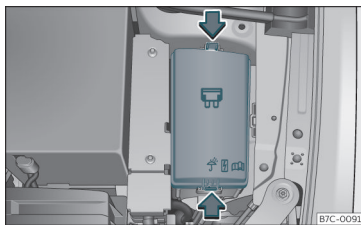

Fig. 90 In the engine compartment: lid of the fuse box.

To open the engine compartment fuse box

- Open the bonnet **(A)** >>> page 310.
- Press the locking tabs to release the fuse box cover >>> **Fig. 90**.
- Then lift the cover out.
- To fit the cover, place it on the fuse box. Push the locking tabs down until they click audibly into place.

Fuse placement

Read the additional information carefully >>> page 45

Only replace fuses with a fuse of the same amperage (same colour and markings) and size.

Fuses in the vehicle interior

No.	Consumers/Amps	
5	Gateway	5
6	Automatic gearbox lever	5
7	Air conditioning and heating control panel, back window heating, auxiliary heating.	10
8	Diagnosis, handbrake switch, light switch, reverse light, interior lighting, driving mode, lit-up door sill	10
9	Steering column	5
10	Radio display	7.5
11	Left lights	40
12	Radio	20
14	Air conditioner fan	40
15	Steering column release	10
16	Connectivity Box	7.5
17	Instrument panel, OCU	7.5
18	Rear camera	7.5
19	Kessy	7.5
20	SCR, engine relay, 1.5	10/15
21	4x4 Haldex Control Unit	15
22	Trailer	15

»

Emergencies

No.	Consumers/Amps	
23	Electric sunroof	30
24	Right lights	40
25	Left door	30
26	Heated seats	30
27	Interior light	30
28	Trailer	25
32	Control unit for parking aid, front camera and radar	7.5/10
33	Airbag	5
34	Reverse switch, climate sensor, electrochromic mirror, rear power sockets (USB)	7.5
35	Diagnosis, headlight control unit, headlight adjuster	10
36	Right LED headlight	7.5
37	Left LED headlight	7.5
38	Trailer	25
39	Right door	30
40	12V socket	20
42	Central locking	40
43	Beats Audio CAN and MOST.	30
44	Trailer	15
45	Electric driver's seat	15

No.	Consumers/Amps	
47	Rear window wiper	15
49	Starter motor; clutch sensor	5
50	Electric rear lid	40
52	Driving mode.	15
53	Heated rear window	30

Fuse arrangement in engine compartment

No.	Consumers/Amps	
1	ESP control unit	25
2	ESP control unit	40
3	Engine control unit	30/15
4	Engine sensors	5/10
5	Engine sensors	7.5
6	Brake light sensor	5
7	Engine power supply	10
8	Lambda probe	10/15
9	Engine	5/10/20
10	Fuel pump control unit	15/20
11	PTC	40
12	PTC	40
13	Automatic gearbox control unit	15/30
14	Heated windscreen	40

No.	Consumers/Amps	
15	Horn	15
16	Petrol pump	5/15/20
17	Engine control unit	7.5
18	Terminal 30 (positive reference)	5
19	Front windscreen washer	30
20	Alarm horn	10
22	Engine control unit	5
23	Starter motor	30
24	PTC	40
31	Pressure pump	15
33	Gearbox pump	30
37	Parking heating	20

Note

- In the vehicle, there are more fuses than those indicated in this chapter. These should only be changed by a specialised workshop.
- Positions not containing a fuse do not appear in the following tables.
- Some of the equipment listed in the tables below pertain only to certain versions of the model or are optional extras.

- Please note that the above lists, while correct at the time of printing, are subject to change.

Changing a bulb

Topic introduction

Read the additional information carefully
»»  page 46.

Full-LED headlights

Full-LED headlights handle all light functions (daylight, side light, turn signal, dipped beam and route light) with light emitting diodes (LEDs) as a light source.

Full-LED headlights are designed to last the lifetime of the car and light bulbs cannot be replaced. In case of headlight failure, go to an authorised workshop to have it replaced.

Rear incandescent light bulbs

	Type
Turn signal	PY21W LL
Reverse lights	W16W
The remaining functions work with LEDs	

⚠ CAUTION

- Remove the ignition key before working on the electric system. Otherwise, a short circuit could occur.
- Switch off the lights and the parking light before changing a bulb.
- Take good care to avoid damaging any components.

♻ For the sake of the environment

Please ask your specialist retailer how to dispose of used bulbs in the proper manner.

i Note

- Please check at regular intervals that all lighting (especially the exterior lighting) on your vehicle is functioning properly. This is not only in the interest of your own safety, but also that of all other road users.
- Before changing a bulb, make sure you have the correct new bulb.
- Do not touch the glass part of the bulb with your bare hands, use a cloth or paper towel instead, since the fingerprints left on the glass will vaporise as a result of the heat generated by the bulb, they will be deposited on the reflector and will impair its surface.

Rear bulbs (in the side panel)

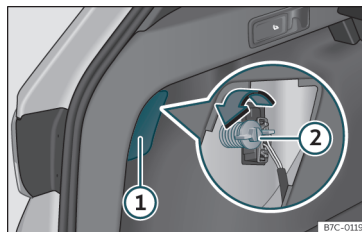

Fig. 91 Boot: access to the bolt securing the tail light unit.

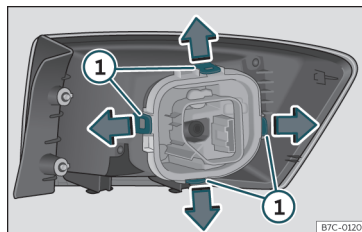

Fig. 92 Retaining tabs on reverse side of tail light.

Follow the steps indicated:

1. Check which of the bulbs is defective.
2. Open the rear lid. »

3. Remove the lid, levering it with the flat side of a screwdriver into the recess »» Fig. 91 ①.
4. Remove the bulb connector.
5. Unscrew the light securing bolt by hand or using a screwdriver »» Fig. 91 ②.
6. Remove the light from the body, gently pulling it toward you, and place on a clean, smooth surface.
7. Disassemble the bulb holder unlocking the securing tabs »» Fig. 92 ①.
8. Change the damaged bulb.
9. To refit follow the steps in reverse order, taking special care when fitting the bulb holder. The securing tabs must click into place.

ⓘ CAUTION

Take care when removing the rear light unit to make sure there is no damage to the paintwork or any of its components.

ⓘ Note

- Make sure you have a soft cloth ready to place under the glass on the rear light unit, to avoid any scratches.
- In the case of LED lights, change only the turn signal bulb.

Rear lights (in the rear lid)

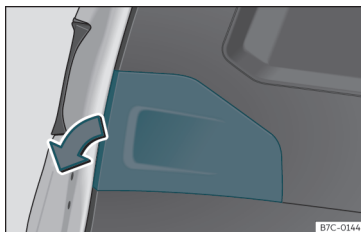

Fig. 93 Rear lid open: remove the lid.

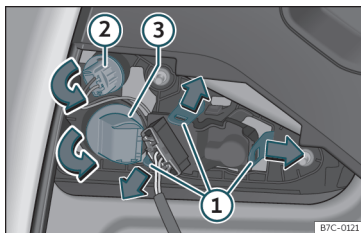

Fig. 94 Remove the bulb holder.

The rear lid must be open to change the bulbs.

Follow the steps indicated:

1. Remove the rear lid cover in the direction indicated »» Fig. 93.

2. Unlock the securing tabs from the bulb holder »» Fig. 94 ① or turn the bulb holder to the left ② and ③.
3. Remove the bulb holder from its location.
4. Lightly press the defective bulb into the bulb holder, then turn it to the left and remove it.
5. Fit the new bulb, pressing it into the bulb holder and turn it to the right as far as it will go.
6. Use a cloth to remove any fingerprints from the glass part of the bulb.
7. Check that the new bulb works properly.
8. Carry out the same actions in reverse order for assembly and pay special attention to placing the bulb holder, ensuring that the tabs are properly secured.

ⓘ Note

For LED pilots, you can only change the reverse bulb.

Changing number plate light bulbs

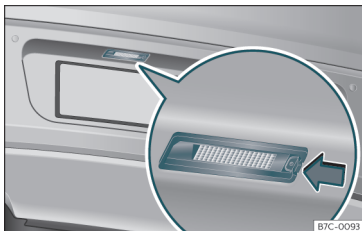

Fig. 95 In the rear bumper: number plate light.

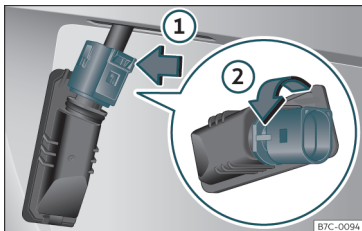

Fig. 96 Number plate light: detach the bulb holder.

Follow the steps indicated:

1. Press the number plate light in the direction of the arrow »» **Fig. 95**.
2. Remove the number plate light.

3. Turn the connector lock »» **Fig. 96** in the direction of arrow ① and pull on the connector.
4. Rotate the bulb holder in the direction of arrow ② and extract it with the bulb.
5. Replace the defective bulb with a new bulb with the same features.
6. Insert the bulb holder in the number plate light and turn in the opposite direction of arrow ② until it stops.
7. Plug the connector into the bulb holder.

Note

Depending on how equipped the vehicle is, the number plate lights may be LEDs. LEDs have an estimated life that exceeds than that of the car. If a light with LEDs fails, go to an authorised workshop for replacement.

Side turn signals

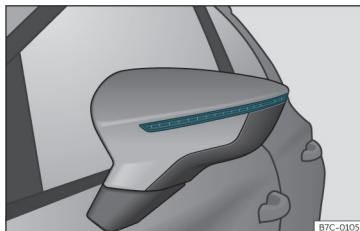

Fig. 97 Turn signal integrated in the rear view mirror

The side turn signals are LEDs and are integrated in the exterior mirrors.

In case of failure, go to an authorised workshop to have them replaced.

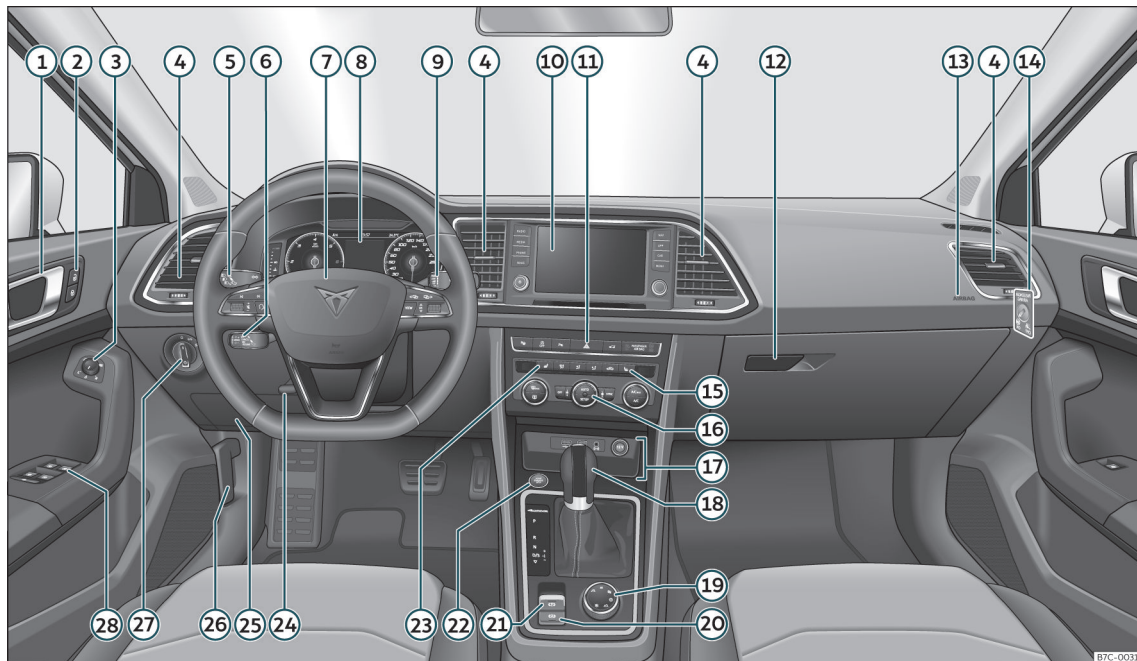

Fig. 98 Instruments and controls.

B7C-0031

Operation

Controls and displays

General instrument panel

① Door release lever			
② Central locking switch	115		
③ Control for the electric adjustment of the exterior mirrors	142		
④ Air vents	161		
⑤ Control lever for:			
– Turn signals and main beam headlights	133		
– Lane Assist	260		
– Main beam assist	134		
– Cruise control system (CCS)	242		
⑥ Depending on equipment fitted:			
– Lever for cruise control	242		
⑦ Steering wheel with horn and			
– Driver airbag	21		
– On-board computer controls	108		
– Controls for radio, telephone, navigation and speech dialogue system	164		
– Paddle levers for tiptronic gearshift (automatic gearbox)	227		
⑧ Instrument panel	94		
⑨ Control lever for:			
– Windscreen wipers and washer	139		
– Wipe and wash system	139		
– On-board computer	99		
⑩ Easy Connect system (navigation, radio, TV/video)	164		
⑪ Depending on the equipment, buttons for:			
– Start-Stop system	238		
– Park assist system	281		
– Hazard warning lights	136		
– Tyre pressure switch	327		
– Airbag off display	72		
⑫ Depending on the equipment, glove compartment with:	148		
– CD player* and/or SD card*	186		
⑬ Front passenger airbag	21		
⑭ Front passenger airbag switch	72		
⑮ Front passenger seat heating control	145		
⑯ Automatic air conditioning controls	39		
⑰ Depending on the equipment:			
– USB/AUX-IN input	212		
– Lighter/power socket	149		
– Connectivity Box/Wireless Charger*	212		
– Storage compartment	147		
⑱ DSG automatic gearbox lever	224		
⑲ Rotating control(Driving Experience button) for driving modes	271		
⑳ Auto Hold switch	241		
㉑ Electronic parking brake switch	217		
㉒ Start-up push button (Keyless Access closing and start-up system)	214		
㉓ Driver's seat heating control	145		
㉔ Steering column adjustment lever	21		
㉕ Knee airbag	23		
㉖ Bonnet lock release	311		
㉗ Headlight switch	132		
㉘ Electric windows	126		

Note

- Some of the equipment listed in this section is only fitted on certain models or are optional extras.
- The arrangement of switches and controls on right-hand drive models* may be slightly different from the layout shown in >>> page 92. However, the symbols used to identify the controls are the same.

Instruments and warning/control lamps

Dashboard

Introduction

After switching the engine on with a 12-volt battery that is heavily discharged or newly changed some system settings (such as the time, the date, the personalised comfort settings and the programming) might be altered or deleted. Check and correct these settings once the battery is sufficiently charged.

WARNING

Any distraction may lead to an accident, with the risk of injury.

- Do not operate the instrument panel controls when driving.
- To reduce the risk of accident and injury, only make adjustments to the instructions on the screen of the instrument panel and to the instructions on the screen of the Infotainment system when the vehicle is stationary.

Digital instrument panel (Digital Cockpit)

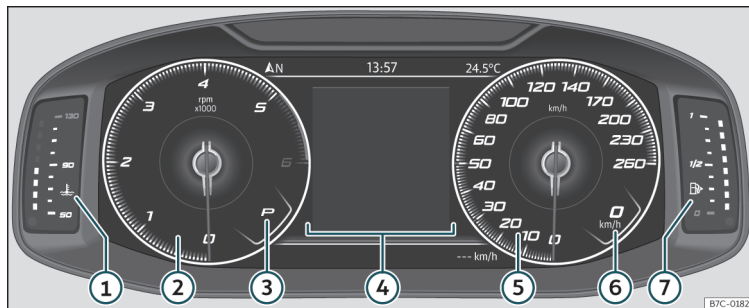

Fig. 99 Digital Cockpit on the instrument panel (classic view).

Details of the instruments:

- ① **Engine coolant temperature display**
»» page 106
- ② **Revolution counter.** Revolutions per minute with the engine running
»» page 105.
- ③ **Gear engaged or position of the selector lever currently selected**
- ④ **Screen display** »» page 96
- ⑤ **Speedometer**
- ⑥ **Digital speed display**
- ⑦ **Fuel gauge** »» page 105.

The Digital Cockpit is a digital instrument panel with a high-resolution TFT colour screen. It has a 3 or 4 views, depending on the version, accessible using the button **VIEW** of the multifunction steering wheel. By selecting different information profiles, indications other than the classic circular instruments can be displayed, such as navigation data, multimedia information or travel data.

Information profiles

With the option **INSTRUMENT PANEL** (Infotainment button **CAR**) > **Vehicle function button** > **View** > **Instrument cluster**)

you can choose between the different display options of the information that appears in the Digital Cockpit.

Classic View

The revolutions per minute and speedometer needles appear along the entire length
»» **Fig. 99.**

View 1, 2, 3 or AUTOMATIC*¹⁾

Personalisation of the information that appears in the Digital Cockpit. Only 2 of these items of information can be displayed at the »

¹⁾ Pre-set information depending on the "Driving mode" selected.

same time, but the user chooses which to display, and in what order, by moving the finger vertically over the dials.

Depending on the version, the Views can be memorised by exiting the menu or keeping the **View** button pressed.

- **Consumption.** Graphic representation of the current consumption and digital display of the average consumption.
- **Audio.** Digital display of the current audio playback.
- **Altitude.** Digital display of the current altitude above sea level.
- **Compass.** Digital display of the compass.
- **Information about the final destination.** Digital display of the remaining travelling time, distance to the destination and the estimated time of arrival.
- **Operating range.** Digital display of the remaining range.
- **Travel time.**
- **Route guidance.**
- **Journey.** Digital display of the distance travelled.
- **Assistance systems.** Graphic representation of different assistance systems.
- **Traffic signs.** Display of traffic signs detected.
- **Navigation.** Graphical representation of the navigation with arrows.

It may vary based on the features, the number and the contents of the selectable information profiles..

Navigation system in the Digital Cockpit*



Fig. 100 Infotainment system: map transfer button

Depending on the features, the Digital Cockpit can display a detailed map. To do this, select the **Navigation** option in the menu menu on the instrument panel >>> page 98.

Depending on the features, the navigation map can be displayed in the Digital Cockpit or on the Infotainment system or on both at the same time. If it is displayed only in the Infotainment system, the Digital Cockpit will only display the arrows for manoeuvres.

Transfer of navigation map

Using the map transfer key >>> **Fig. 100**, the map is transferred from the Infotainment system to the Digital Cockpit and vice versa.

Using the right thumbwheel of the multifunction steering wheel, in the **Navigation** menu, you can transfer the map back to the Infotainment System.

Display indications

Possible indications on the instrument panel display

Different pieces of information can be displayed on the screen of the instrument panel, depending on the features of the vehicle.

- Doors, bonnet and rear lid open
- Warning and information messages
- Odometer
- Time >>> page 104
- Indications of the radio and navigation system
- Indications of the phone
- Outside temperature
- Indications of the compass
- Selector lever positions
- Gear recommendation (Triptonic mode) >>> page 227

- Display of travel data (multifunction display) and menus for different settings »» page 98

- Service interval display »» page 106

- Speed warning »» page 99

- Speed warning for winter tyres

- Start-Stop system status display

»» page 238

- Signs detected by the traffic signal detection system »» page 102

- Identifying letters on engine (LDM)

- Driver assistance system display

»» page 238

Doors, bonnet and rear lid open

When the vehicle is unlocked and while driving, the instrument panel display shows if any of the doors, the bonnet or rear lid are opened and, in some cases, it is also indicated by an audible warning. The display may vary according to the type of instrument panel fitted.

Selector lever positions (dual-clutch DSG®)

The current position of the selector lever is shown on the side of the lever and on the instrument panel display. When the lever is in the **D/S** position or in the Tiptronic position, in some cases, the gear engaged in each

case is shown on the instrument panel display.

Outside temperature display

If the outside temperature is lower than approximately +4 °C (+39 °F), the “ice crystal symbol” ❄ on the outside temperature display also lights up. This symbol remains lit until the outside temperature exceeds +6 °C (+43 °F) »» .

When the vehicle is stationary, when the auxiliary heater is switched on or when driving at very low speeds, the outside temperature indicated may be higher than the actual temperature due to the heat produced by the engine.

The margin of measurement ranges from -45 °C (-49 °F) to +76 °C (+169 °F).

Driving recommendation

While driving, the instrument panel of certain vehicles may indicate a gear recommendation for saving fuel »» page 227.

Odometer



The *odometer* registers the total distance travelled by the car.

The *partial odometer (trip)* shows the distance travelled since the last time it was reset to zero.

- Set the odometer to zero via the Infotainment system or the multifunction steering wheel »» page 99.

Speed warning for winter tyres

If the maximum speed set is exceeded, this is displayed on the instrument panel »» page 98.

The speed warning can be adjusted on the Infotainment system: using button  > **SETTINGS > Driver Assistance** »»  page 33 button.

Compass indication

Depending on the equipment, when the ignition is on, the instrument panel display indicates the direction in which you are driving with a symbol, e.g. NW for Northwest.

When the Infotainment system is on and there is no route guidance active, the graphic representation of a compass is also shown.

Identifying letters on engine (LDM)

- Select the information profile **Range** in the instrument cluster (Infotainment button  /> **View > Driving data > Range** function button).

- Press and hold the button  on the multifunction steering wheel until the menu Service is displayed on the instrument panel display »» page 98.

»

- Select the menu option **Engine code**.

WARNING

Even when the outside temperature is higher than freezing temperature, some roads and bridges could be frozen.

- The “ice crystal symbol” indicates that there may be a risk of freezing.
- At outside temperatures above +4 °C (+39 °F), there may be ice even when the “ice crystal symbol” is not on.
- The outside temperature sensor takes a guideline measurement.

Note

- There are different instrument panels and therefore the versions and instructions on the display may vary. In the case of displays without warning or information texts, faults are indicated exclusively by the control warning lamps.
- Some indications on the instrument panel screen may be concealed by a sudden event, e.g. an incoming call.
- Depending on the equipment, some settings and instructions can be carried out or displayed on the infotainment system as well.
- If there are several warnings at the same time, the symbols will be displayed one after the other for a few seconds. The symbols will stay on until you remove the cause.

- If when switching on the ignition warnings are shown about existing faults, it might not be possible to change the settings or show the information as described. In this case, go to a specialised workshop and request a repair.

Instrument panel menus

The number of menus and information items available will depend on the vehicle's electronics and features.

A specialised workshop can programme or modify additional functions, according to the vehicle equipment. To do so, CUPRA recommends going to a specialised CUPRA dealer or any SEAT dealership.

Some menu options can only be read when the vehicle is stationary.

- **Driving data** »» page 99
- **Assistance systems.**
 - Lane Assist On/Off »» page 260
 - Front Assist On/Off »» page 247
 - Blind spot detector On/Off »» page 265
 - ACC (only display) »» page 251
- **Navigation.**
- **Audio.**
- **Telephone.**
- **Vehicle status** »» page 100

Service Menu

In the Service menu various settings can be adjusted depending on the features.

Open the Service menu

To open the Service menu, select the information profile **Range** (Infotainment button **CAR** > **View** > **Driving data** > **Range** button) and press and hold the **OK** button on the multifunction steering wheel for around 4 seconds. You can browse the menu with the buttons on the multifunction steering wheel in the usual manner.

Restart the service interval display

Select the **Service** menu and follow the instructions on the screen of the instrument panel.

Restart the oil service

Select the **Restore Oil service** menu and follow the instructions on the instrument panel display.

Restart journey data

Select the **Reset trip** menu and follow the instructions on the instrument panel display to reset the value.

Identifying letters on engine (LDM)

Select the menu **Engine code**. The identifying letters of the engine will be shown on the instrument panel display.

Setting the clock

Select the **Time** menu and set the correct time by turning the right thumbwheel of the multifunction steering wheel.

Journey data display (multifunction display)

The display of the travel data (multifunction display) shows different values about the journey and the consumption.

Change from one display to another

- Turn the right thumbwheel of the multifunction steering wheel »» page 108.

Changing memory

Press the **OK** button on the multifunction steering wheel.

Since start The memory is deleted if the journey is interrupted for more than 2 hours.

Since refuelling Display and storage of the journey data and the consumption

values collected. When refuelling, the memory is deleted.

Long-term This memory contains travel data up to a maximum of 19 hours and 59 minutes or 99 hours and 59 minutes, or up to a maximum of 1999.9 km or 9999.9 km. When one of these values is exceeded (varies depending on the version of the instrument panel), the memory is deleted.

Delete journey data presets

- Select the memory that you wish to erase.
- Keep the **OK** button on the multifunction steering wheel pressed for approximately 2 seconds.

Select the instructions

In the Infotainment system, in the menu Vehicle settings, you can display different travel data »»  page 33.

Current fuel consumption The current fuel consumption display operates throughout the journey, in litres/100 km; and with the engine running and the vehicle stopped, in litres/hour.

Average fuel consumption The average fuel consumption is displayed after driving for approximately 300 metres.

Travelling time This indicates the hours (h) and minutes (min) since the ignition was switched on.

Operating range Approximate distance in km that can still be travelled if the same driving style is maintained.

Distance travelled Distance covered in km (m) after switching on the ignition.

Average speed The average speed will be shown after driving for approximately 100 metres.

Digital speed Current speed displayed in digital format.

Convenience consumers Displays a list of the connected comfort systems that increase energy consumption, e.g. air conditioning.



Set a speed warning

- Select the display **Speed warning at --- km/h** or **Speed warning at --- mph**.
- Press the **OK** button on the multifunction steering wheel to memorise the current speed and activate the warning.
- **Activate:** set the desired speed within 5 seconds by rotating the wheel on the multifunction steering wheel. Next, press the **OK** button again or wait several seconds. The speed is stored and the warning activated.
- **Deactivate:** press the **OK** button. The stored speed is deleted.

»

The warning can be adjusted for speeds between 30 km/h (18 mph) and 250 km/h (155 mph).

Display Oil temperature

The engine reaches its operating temperature when, under normal driving conditions, the oil temperature is between 80°C and 120°C. If the engine is under a lot of stress and the outside temperature is high, the engine oil temperature can increase. This does not present any problem as long as the warning lamps  or  [»» page 314](#) do not appear on the display.

Warning and information messages (Vehicle status)

The system runs a check on certain components and functions when the ignition is switched on and while the vehicle is moving. Faults displayed on the instrument panel as red and yellow warning symbols accompanied with messages and [»» !\[\]\(950a62bbddad88d64435fd35607dfc42_img.jpg\) page 36](#), depending on the case, even an audible warning. The representation of the messages and symbols may vary depending on the version of the instrument panel.

Existing faults can also be checked manually. To do so, open the menu **Vehicle status** or **Vehicle** [»» page 98](#).

Priority 1 warning (red). The symbol lights up or flashes (in part accompanied by audible warnings).  **Stop driving!** Danger! Check the fault and eliminate the cause. If necessary, seek professional assistance.

Priority 2 warning (yellow). The symbol lights up or flashes (in part accompanied by audible warnings). Operating faults or the lack of operating fluids can cause damage to the vehicle or a fault. Check the faulty function as soon as possible. If necessary, seek professional assistance.

Information message. It provides information about processes in the vehicle.

Note

- Depending on the equipment, some settings and instructions can be carried out or displayed on the infotainment system as well.
- If there are several warnings at the same time, the symbols will be displayed one after the other for a few seconds. The symbols will stay on until you remove the cause.
- If when switching on the ignition warnings are shown about existing faults, it might not be possible to change the settings or show the information as described. In this case, go to a specialised workshop and request a repair.

Fatigue detection (break recommendation)*

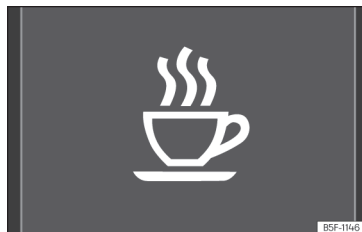

Fig. 101 On the screen of the instrument panel: fatigue detection.

The Fatigue detection informs the driver when their driving behaviour shows signs of fatigue.

Function and operation

Fatigue detection determines the driving behaviour of the driver when starting a journey, making a calculation of tiredness. This is constantly compared with the current driving behaviour. If the system detects that the driver is tired, an audible warning is given with a sound and an optic warning is shown with a symbol and complementary message on the instrument panel display [»» Fig. 101](#). The message on the instrument panel display is shown for approximately 5 seconds,

and depending on the case, is repeated. The system stores the last message displayed.

The message on the instrument panel display can be switched off by pressing the **OK** button on the multi-function steering wheel >>> page 108.

The message can be recalled to the instrument panel display using the multifunction display >>> page 99.

Conditions of operation

Driving behaviour is only calculated on speeds above about 65 km/h (40 mph) up to around 200 km/h (125 mph).

Switching on and off

Fatigue detection can be activated or deactivated in the Easy Connect system with the **CAR** / button and the **SETTINGS** function button >>>  page 33. A mark indicates that the adjustment has been activated.

System limitations

The Fatigue detection has certain limitations inherent to the system. The following conditions can limit the Fatigue detection or prevent it from functioning.

- At speeds below 65 km/h (40 mph)

- At speeds above 200 km/h (125 mph)
- When cornering
- On roads in poor condition
- In unfavourable weather conditions
- When a sporty driving style is employed
- In the event of a serious distraction to the driver

Fatigue detection will be restored when the vehicle is stopped for more than 15 minutes, when the ignition is switched off or when the driver has unbuckled their seat belt and opened the door.

In the event of slow driving during a long period of time (below 65 km/h, 40 mph) the system automatically re-establishes the tiredness calculation. When driving at a faster speed the driving behaviour will be recalculated.

WARNING

Do not let the comfort afforded by the Fatigue detection system tempt you into taking any risks when driving. Take regular breaks, sufficient in length when making long journeys.

- The driver always assumes the responsibility of driving to their full capacity.
- Never drive if you are tired.

- The system does not detect the tiredness of the driver in all circumstances. Consult the information in the section >>> page 101, System limitations.
- In some situations, the system may incorrectly interpret an intended driving manoeuvre as driver tiredness.
- No warning is given in the event of the effect called microsleep!
- Please observe the indications on the instrument panel and act as is necessary.

Note

- Fatigue detection has been developed for driving on motorways and well paved roads only.
- If there is a fault in the system, have it checked by a specialised workshop.

Traffic sign detection system*1)

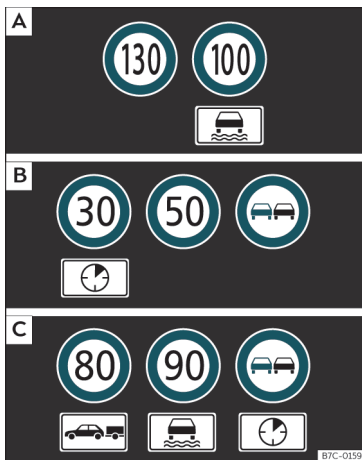

Fig. 102 On the instrument panel display: examples of speed limits or overtaking prohibitions with their respective additional signs.

The traffic sign detection system records the standard traffic signs in front of the vehicle with a camera located on the base of the interior mirror and provides information about speed limits and overtaking prohibitions.

Within its limitations, the system also displays additional signals, such as time-specific prohibitions, signs for vehicles towing trailers >>> page 296 or limitations that only apply in the event of rain. Even on journeys without signs, the system may display any applicable speed limits.

The traffic sign detection system does not work in all countries. Keep this in mind when travelling abroad.

Indication on the display

In Germany, on motorways and vehicle roads, besides speed limits and overtaking provisions the system also displays the end of prohibition signs. The valid speed limit at the time in other countries is always shown.

The traffic signs detected by the system are displayed on the dash panel display >>> **Fig. 102** and, depending on the navigation system fitted in the vehicle, on the infotainment system as well >>>  page 33.

Traffic sign detection system messages

Message	Cause and solution
There are no traffic signs available	The system is starting up. OR: the camera has not recognised any obligation or prohibition signs.

Message	Cause and solution
Error: Detection of traffic signs	There is a fault in the system. Have the system checked by a specialised workshop.
Speed warning currently unavailable.	The speed warning function of the traffic sign detection system is faulty. Have the system checked by a specialised workshop.
Detection of traffic signs: Clean the windscreen!	The windscreen is dirty in the camera area. Clean the windscreen.
Detection of traffic signs: Limited at the moment	No data transfer by the navigation system. Check whether the navigation system has current maps. OR: the vehicle is currently in a region that is not included in the navigation system's map.
No data available	The traffic sign detection system does not work in the current country.

Activating and deactivating traffic sign display on the instrument panel

The permanent display of traffic signs on the instrument panel can be activated or deactivated in the infotainment system using the

¹⁾ System available depending on the country.

CAR > SETTINGS > Driver Assistance function buttons.

Display of traffic signs

When the traffic sign detection system is connected, a camera located on the base of the interior rear-view mirror records the traffic signs in front of the vehicle. After checking and evaluating the information from the camera, the navigation system and the current vehicle data, up to three valid traffic signs are displayed >>> **Fig. 102 B** in conjunction with their corresponding additional signs.

First: The sign that is currently valid for the driver is shown in the left side of the screen. For example, a maximum speed limit of **130 km/h (100 mph)** >>> **Fig. 102 A**.

Second: A sign valid only in certain circumstances, e.g. **100 km/h (60 mph)** is shown second, together with the additional rain sign.

Additional sign: If the windscreen wiper is working while you are driving, the signal with the additional rain sign will be shown first, on the left, as it is the one that is applicable at the time.

Third: A sign valid only with restrictions, e.g. No overtaking at certain times, will be displayed third >>> **Fig. 102 C**.

Speed warning

If the system detects that the permitted speed is exceeded, it may warn the driver with a “gong” and visually with a message on the dash panel display.

The speed warning can be adjusted or deactivated completely in the infotainment system using the **CAR** > SETTINGS > Driver Assistance function buttons >>>  page 33. The speed is adjusted in steps of 5 km/h (3 mph) within a range of between 0 km/h (mph) and 20 km/h (12 mph) above the maximum speed permitted.

Trailer mode

In vehicles equipped with a towing bracket device from the factory and a trailer that is electrically connected to the vehicle, it is possible to activate or deactivate the display of specific traffic signs for vehicles with trailer, such as speed limits or overtaking prohibitions. Activation or deactivation is performed on the infotainment system using the **CAR** > SETTINGS > Driver Assistance function buttons >>>  page 33.

For trailer mode, the display of speed limits applicable to the type of trailer or to the legal provisions can be adjusted. The speed is adjusted in steps of 10 km/h (5 mph) within a range of between 60 km/h (40 mph) and 130 km/h (80 mph). If it is adjusted to a speed greater than that which is permitted in

the country in question for driving with a trailer, the system automatically displays the usual speed limits, e.g. in Germany 80 km/h (50 mph).

If the speed warning for the trailer is deactivated, the system displays the speed limits as if there were no trailer hitched.

Limited operation

The traffic sign detection system has certain limitations. The following cases may lead the system to operate with limitations or not at all:

- In the case of poor visibility, e.g. in snow, rain, fog or intense mist.
- In cases of dazzling, e.g. caused by head-on traffic or by the sun.
- When driving at high speeds.
- If the camera is covered or dirty.
- If the traffic signs are out of the camera's field of vision.
- If the traffic signs are partially or totally covered, e.g. by trees, snow, dirt or other vehicles.
- In the case of traffic signs that do not fulfil the regulations.
- In the case of damaged or bent traffic signs.

»

- In the case of variable messages on overhead or gantry signs (LED-based variable traffic signs or other lighting units).
- If the maps on the navigation system are not up-to-date.
- In the case of adhesives affixed to vehicles that depict traffic signs, e.g. speed limits on lorries.

WARNING

The technology in the traffic sign detection system cannot change the limits imposed by the laws of physics and only works within the system's limits. Do not let the extra convenience afforded by the traffic sign detection system tempt you into taking any risks when driving. The system is not a replacement for driver awareness.

- Adapt your speed and driving style to suit visibility, weather, road and traffic conditions.
- Poor visibility, darkness, snow, rain and fog may lead to the system failing to display traffic signs or not displaying them correctly.
- If the camera's field of vision is dirty, covered or damaged, system operation may be impaired.

WARNING

The driving recommendations and traffic indications shown on the traffic sign detec-

tion system may differ from the actual current traffic situation.

- The system may not detect or correctly show all the traffic signs.
- Traffic signs and traffic regulations have priority over the recommendations and displays provided by the system.

WARNING

If messages are ignored, the vehicle may stall in traffic and cause accidents and severe injuries.

- Never ignore the messages displayed.
- Stop the vehicle at the next opportunity and in a safe place.

Note

In order not to compromise the system's operation, please take the following points into account:

- Regularly clean the area of vision of the camera and keep it in a clean state, without snow or ice.
- Do not cover the field of vision of the camera.
- Always replace damaged or worn blades when required to avoid lines on the camera's field of vision.
- Check that the windscreen is not damaged in the area of the camera's field of vision.



- The use of outdated maps on the navigation system may cause the system to show traffic signs incorrectly.
- In the waypoints mode of the navigation system, the traffic sign detection system is only partly available.
- Failure to heed the control lamps and corresponding text messages when they light up may result in damage to the vehicle.

Time

Setting the time on the infotainment system

- Press the infotainment  button.
- Press the **SETTINGS** function button.
- Select the menu option **Date and time** to set the time >>>  page 33.

Adjusting the time in the Digital Cockpit

- While on the **Driving data** menu select **Range** (Infotainment button  > **View** > **Driving data** > **Range**).
- Press the button  on the multifunction steering wheel until the Service menu is displayed on the instrument panel display >>> page 98.
- Select the menu **Time**.

- Adjust the correct time by turning the right thumbwheel of the multifunction steering wheel.

Revolution counter

The rev counter indicates the number of engine revolutions per minute.

Together with the gear-change indicator, the rev counter offers you the possibility of using the engine of your vehicle at a suitable speed.

The beginning of the red zone of the rev counter indicates the maximum speed in any gear after running-in and with the engine hot. However, it is advisable to move the selector lever to **D** or lift your foot off the accelerator before the needle reaches the red zone >>> **!**

We recommend that you avoid high revs and that you follow the recommendations on the gear-change indicator. Consult the additional information in >>> page 227, Gear recommendation.

! CAUTION

- To prevent damage to the engine, the rev counter needle should only remain in the red zone for a short period of time.

- When the engine is cold, avoid high revs and heavy acceleration and do not make the engine work hard.

🌿 For the sake of the environment

Changing up a gear early will help you to save fuel and minimise emissions and engine noise.

Fuel level indicator



Fig. 103 Fuel gauge.

Control lamps



It lights up, and in addition, the low-er diode lights up in red

Fuel tank almost empty. The fuel reserve level has been reached >>> **!** Refuel as soon as possible. When the fuel level is very low, the lower diode flashes in red.

The display only works when the ignition is switched on.

The fuel range is displayed on the instrument panel.

You can consult the tank capacity of your vehicle in the >>> **📖** page 41 section.

⚠️ WARNING

When driving with low fuel, the vehicle may stall in traffic and cause accidents and severe injuries.

- If the fuel tank level is too low, fuel could reach the engine irregularly, particularly when driving up or down slopes.
- The steering system and the driver assistance systems and brakes do not work when the engine is running irregularly or switches off due to lack of fuel or an irregular supply thereof.
- Always refuel when there is only one quarter of fuel in tank to prevent the vehicle to stop due to lack of fuel.

! CAUTION

Never run the fuel tank completely dry. An irregular fuel supply can cause misfiring and unburnt fuel could enter the exhaust system. The catalytic converter or the particulate filter may get damaged!

>>

Note

The small arrow on the fuel gauge next to the fuel pump symbol points out towards the side of the vehicle with the fuel tank flap.

Engine coolant temperature display

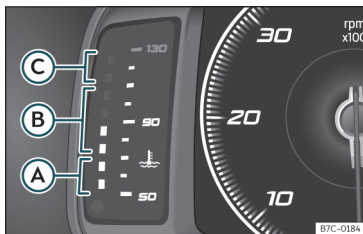



Fig. 104 Engine coolant temperature indicator.

>>> Fig. 104:

- A Cool zone.** The engine has not reached operating temperature yet. Avoid high engine speeds and stressing the engine if it has not reached operating temperature.
- B Normal zone.** At high outside temperatures and when making the engine work hard, the diodes may continue lighting up and reach the upper zone. This is no

cause for concern, provided the control lamp does not light up 

- C Warning area.** When the engine is working hard, especially at high outside temperatures, the diodes may light up in the warning area.

The coolant temperature gauge only works when the ignition is switched on.

Control and warning lamp



It lights up red



Do not keep driving!

Engine coolant level too low, coolant temperature too high



Flashes red

Fault in the engine coolant system.

- Stop the vehicle, switch off the engine and let it cool down.
- Check the engine coolant level >>> page 316.
- If the warning lamp does not switch off even if the coolant level is correct, request assistance from specialised personnel.



CAUTION

- To ensure a long useful life for the engine, avoid high revs, driving at high speed and making the engine work hard for approxi-

mately the first 15 minutes when the engine is cold. The phase until the engine is warm also depends on the outside temperature. If necessary, use the engine oil temperature* >>> page 100 as a guide.

- Additional lights and other accessories in front of the air inlet reduce the cooling effect of the coolant. At high outside temperatures and high engine loads, there is a risk of the engine overheating.
- The front spoiler also ensures proper distribution of the cooling air when the vehicle is moving. If the spoiler is damaged this can reduce the cooling effect, which could cause the engine to overheat. Seek specialist assistance.

Service intervals

The service interval indication appears on the instrument panel display and the Infotainment system.

There are different versions of instrument panels and infotainment systems, so the versions and instructions on the screens may vary.

CUPRA distinguishes between services *with* engine oil change (e.g. Oil change service) and services *without* engine oil change (e.g. Inspection).

In vehicles with **Services established by time or mileage**, the service intervals are already pre-defined.

In vehicles with **LongLife Service**, the intervals are determined individually. Thanks to technological progress, maintenance work has been greatly reduced. Because of the technology used by CUPRA, with this service you only need to change the oil when the vehicle so requires. To calculate this variation (max. 2 years), the vehicle's conditions of use and individual driving styles are considered. The advance warning first appears 20 days before the date established for the corresponding service. The kilometres (miles) remaining until the next service are always rounded up to the nearest 100 km (miles) and the time is given in complete days. The current service message cannot be viewed until 500 km after the last service. Prior to this, only lines are visible on the display.

Inspection reminder

If a service or an inspection has to be carried out soon, a **service reminder** will be displayed when the ignition is switched on.

The figure displayed are the kilometres that can still be travelled or the time until the next service.

Service due



When the **time for a service** or an **inspection** comes, an audible warning will be emitted when the ignition is switched on and the fixed key symbol  may appear on the instrument panel for a few seconds, along with one of the following messages:

- **Service now!**
- **Request an inspection.**
- **Oil service required!**
- **Oil service and inspection required!**

Check a service warning

With the ignition switched on, the engine off and the vehicle at a standstill, the current **service notification** can be read:

Check the date of the current service on the infotainment system

- Press the infotainment  button.
- Press the **SETTINGS** function button >>>  page 33.
- Select the **Service** menu option to display information about the services.

Checking the date on the digital instrument panel

- The date of the service can only be read through the Service menu >>> page 98.

Resetting service interval display

If the service was not carried out by a specialised CUPRA dealer or SEAT dealership, the display can be reset as follows:

- The service interval display can only be reset through the Service menu >>> page 98.

Do not restart the indicator between the service intervals, otherwise the information displayed will be incorrect.

If the oil change service is reset manually, the service interval display changes to a fixed service interval, also in vehicles with **Flexible oil change service**.

Note

- The service message disappears after a few seconds, when the engine is started or when the  button is pressed on the multi-function steering wheel.
- In vehicles with the LongLife system in which the battery has been disconnected for a long period of time, it is not possible to calculate the date of the next service. Therefore the service interval display may not be correct. In this case, bear in mind the maximum service intervals permitted >>> page 331.
- If you reset the display manually, the next service interval will be indicated as in vehicles with fixed service intervals. For this >>>

reason we recommend that the service interval display be reset by an authorised dealer.

Using the instrument panel

Introduction

With the ignition switched on, it is possible to read the different functions of the display by scrolling through the menus.

The multifunction display can only be controlled from the buttons on the multifunction steering wheel.

Some menu options can only be read when the vehicle is at a standstill.

WARNING

Distracting the driver in any way can lead to an accident and cause injuries.

- Never use the menus on the instrument panel display while the vehicle is in motion.

Note

After loading or changing the 12-volt battery, check the system settings. If the power supply is interrupted, the system settings might be incorrect or deleted.

Using the multifunction steering wheel

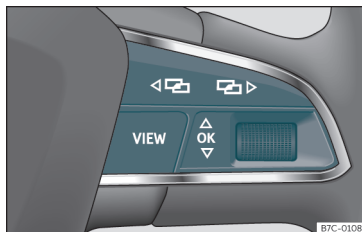







Fig. 105 Right side of multifunction steering wheel: buttons to the menus and informative indications on the instrument panel.

As long as a priority 1 >>> page 100 warning is active, it will not be possible to access any menu. Some warnings can be confirmed and hidden with the button  of the multifunction steering wheel >>> Fig. 105.

Select a menu or an informative display

- Switch the ignition on.
- If a message or vehicle symbol is displayed, press the button  >>> Fig. 105; if necessary, several times.
- To change menus, use buttons  or  >>> Fig. 105.
- To open the menu or the information displayed, press the button  >>> Fig. 105 or

wait a few seconds until the menu or the informative display opens automatically.

Changing menu settings

- In the menu displayed, turn the right thumbwheel of the multifunction steering wheel >>> Fig. 105 until the desired option of the menu is highlighted. The option appears framed.
- Press the button  >>> Fig. 105 to make the required modifications. A mark indicates that the system or function is activated.

Back to menu selection

Press the button  or  >>> Fig. 105.

Note

If when switching on the ignition warnings are shown about existing faults, it might not be possible to change the settings or show the information as described. In this case, go to a specialised workshop and request a repair.

Key for the driving assistance systems*

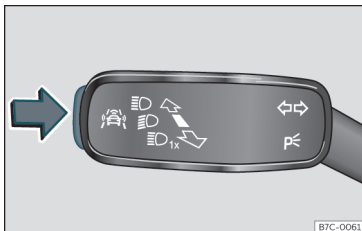

Fig. 106 On the turn light and main beam headlight lever button, you can activate or deactivate the driver assistance systems displayed in the **Assistance systems** menu.

With the turn signal and main beam headlight lever button, you can activate or deactivate the driver assistance systems displayed in the **Assistance systems** menu.

Activate or deactivate a driver assistance system

- Briefly press the button >>> **Fig. 106** in the direction of the arrow to open the menu **Assistance systems**.
- Select the driver assistance system and activate or deactivate it >>> page 108. A mark indicates that driver assistance system is switched on.
- **Next**, confirm the selection by pressing the **OK** button on the multi-function steering wheel.

The driver assistance systems can also be switched on and off in the infotainment system, in the menu **Vehicle settings** >>> page 33.

Control lamps

Control and warning lamps

Read the additional information carefully >>> page 36.

The control and warning lamps are indicators of warnings, >>> , faults >>> or certain functions. Some control and warning lamps come on when the ignition is switched on, and switch off when the engine starts running, or while driving.

Depending on the model, additional text messages may be viewed on the instrument panel display. These may be purely informative or they may be advising of the need for action >>> page 94, **Dashboard**.

Depending upon the equipment fitted in the vehicle, instead of a warning lamp, sometimes a symbol may be displayed on the instrument panel.

When certain control and warning lamps are lit, an audible warning is also heard.

WARNING

If the warning lamps and messages are ignored, the vehicle may stall in traffic, or may cause accidents and severe injuries.

- Never ignore the warning lamps or text messages.
- Stop the vehicle safely as soon as possible.
- Park the vehicle away from traffic and ensure that there are no highly flammable materials under the vehicle that could come into contact with the exhaust system (e.g. dry grass, fuel).
- A faulty vehicle represents a risk of accident for the driver and for other road users. If necessary, switch on the hazard warning lamps and put out the warning triangle to advise other drivers.
- Before opening the bonnet, switch off the engine and allow it to cool.
- In any vehicle, the engine compartment is a hazardous area and could cause severe injuries >>> page 310.

CAUTION

Failure to heed the control lamps and text messages when they appear may result in faults in the vehicle.

Multifunction steering wheel

Operating the audio, telephone and navigation system with voice control

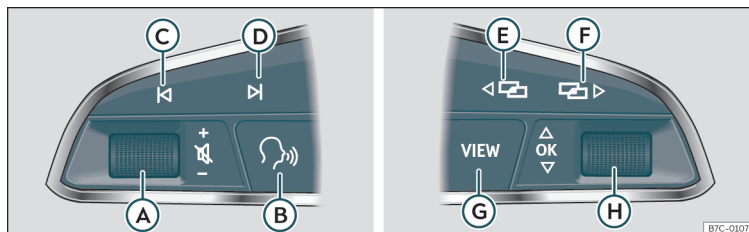

Fig. 107 Controls on the steering wheel.

The steering wheel includes a multifunction module from where it is possible to control

the audio, telephone and radio/navigation functions without needing to distract the driver.

Button	Radio	Media (except AUX)	AUX	Telephone*	Navigation*
A Turn	Turn volume up/down. You do not need to be in audio mode (radio).	Turn volume up/down. You do not need to be in audio mode (media).	Turn volume up/down. You do not need to be in audio mode (media).	Turn volume up/down. You do not need to be in telephone mode.	Turn announcement volume up/down. You do not need to be in navigation mode but there has to be an announcement active when you adjust the volume.
A Press	Mute volume.	Mute volume.	Mute volume.	Mute incoming call.	Mute the current navigation announcement.
B ^{a)}	Enable/disable voice control ^{b)} . This function can be used from any mode, except with an active call.				
C / D	Search for the previous/next station ^{c)} .	<i>Short press:</i> Switch to the previous/next song. <i>Hold down:</i> Fast rewind/forward ^{d)} .	No function	- No active call: Radio/Media functions (except AUX) - Active call: no function	No function for the other modes (navigation, assistants, vehicle status, travel data).

Instruments and warning/control lamps

Button	Radio	Media (except AUX)	AUX	Telephone*	Navigation*
E / F ^{a)}	Change menu on instrument panel. ^{b)}				
G	<i>Short press</i> ^{b)} : change views Classic Info / Digital Maps / Semicircular clocks / Sport . <i>Long press</i> ^{b)} : access settings of "Individual Profiles".				
H Turn	List of sources available (audio/media).	List of sources available (audio/media).	No function	– <i>There is no active call</i> : Recent calls list. – <i>Active call</i> : go to the call options list (call in standby, hang up, mute microphone, private number, etc.).	– <i>Navi System Plus</i> : Zoom in/out (with and without active route). – <i>Navi System</i> : If there is a map on the Digital Scorecard: Zoom in-out (with and without active route). If there is no map on the Digital Scorecard: the map is transferred from the Infotainment System display to the Digital Scorecard (with and without active route).
H Press	No function	No function	No function	No function	Auto/Manual Zoom Zoom if the map on the DigitScorecard.

a) According to the vehicle's equipment package.

b) This function can be used from any mode (audio, media, navigation, vehicle status, travel data).

c) This action can be performed when you are listening to the radio; there is no need to be in audio-radio mode.

d) These actions can be performed when you are listening to media; there is no need to be in audio-radio mode.

Opening and closing

Central locking

Description

Read the additional information carefully
 >>>  page 15

The vehicle can be locked and unlocked via the central locking system. There are several methods, depending on the vehicle equipment:

- key with remote control >>> page 114,
- lock on driver door (emergency opening >>>  page 15) or
- interior central locking switch >>> page 115.

Unlocking one side of the vehicle only

When you lock the vehicle with the key, the doors and the rear lid are locked. When you open the door, you can either unlock *only* the driver door, or all the vehicle doors. To select the required option, use Easy Connect* >>> page 114.

Auto Lock*

The Auto Lock function locks the doors and the rear lid when the vehicle exceeds a speed of about 15 km/h (9 mph).

The vehicle is unlocked again when the ignition key is removed. Alternatively, the vehicle can also be unlocked via the central locking switch or by pulling one of the inside door handles. The Auto Lock function can be switched on and off on the sound system or on the Easy Connect* system >>> page 114.

In the event of an accident in which the airbags inflate, the doors will be automatically unlocked to facilitate access and assistance.

Anti-theft alarm system*

If the anti-theft alarm system senses interference with the vehicle it triggers an audible and visible alarm.

The anti-theft alarm system is automatically switched on when locking the vehicle. It switches off when the vehicle is unlocked from a distance.

When the driver door is unlocked with the key, you should switch on the ignition within 15 seconds. Otherwise the alarm will be triggered. On some export versions, the alarm is triggered immediately when you open a door.

To deactivate the alarm, press the  button on the remote control key, or switch on the ignition. After a certain time, the alarm will automatically switch off.

Switch off the vehicle interior monitoring and tow-away protection if you wish to prevent

the alarm from being triggered accidentally >>> page 123.

Turn signals

The turn signals will flash twice when the vehicle is unlocked and once when the vehicle is locked.

If it does not flash, this indicates that one of the doors, the rear lid or the bonnet is not closed correctly.

Accidental lock-out

The central locking system prevents you from being locked out of the vehicle in the following situations:

- If the driver door is open, the vehicle cannot be locked with the central locking switch >>> page 115.

Lock the vehicle with the remote control key, when all the doors and the rear lid have been closed. This prevents the accidental locking of the vehicle.

WARNING

Do not leave anyone (especially children) in the vehicle if it is locked from the outside and the anti-theft security system* is enabled, as the doors and windows cannot then be opened from the inside. Locked doors could delay assistance in an emergency, potentially putting lives at risk.

Note

- Never leave any valuable items in the vehicle unattended. Even a locked vehicle is not a safe.
- If the diode on the driver door sill lights up for about 30 seconds when the vehicle is locked, the central locking system or anti-theft alarm* is not working properly. You should have the fault repaired at a specialised CUPRA dealer, SEAT Official Service or specialised workshop.
- The vehicle interior monitoring of the anti-theft alarm* system will only function as intended if the windows and the sunroof* are closed.

Car key

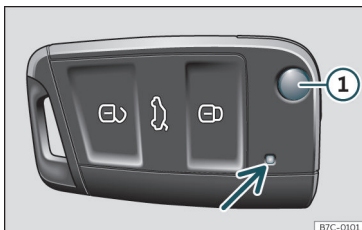

Fig. 108 Vehicle key

Vehicle key

With the vehicle key the vehicle may be locked or unlocked remotely »» page 112.

The vehicle key includes an emitter and battery. The receiver is in the interior of the vehicle. The range of the vehicle key with remote control and new battery is several metres around the vehicle.

If it is not possible to open or close the vehicle using the remote control key, this should be re-synchronised »» page 121 or the battery changed »» page 120.

Different keys belonging to the vehicle may be used.

Control lamp on the vehicle key

When a button on the vehicle key is pressed, the control lamp flashes »» Fig. 108 (arrow) once briefly, but if the button is held down for a longer period the control lamp flashes several times, such as in convenience opening.

If the vehicle key control lamp does not light up when the button is pressed, replace the key's battery »» page 120.

Unfolding and folding the key shaft

Press button ① »» Fig. 108 to unlock and unfold the key shaft.

To fold the shaft away, press button ① and fold the key shaft in until it locks in place.

Spare key

To obtain a spare key and other vehicle keys, the vehicle chassis number is required.

Each new key contains a microchip which must be coded with the data from the vehicle electronic immobiliser. A vehicle key will not work if it does not contain a microchip or the microchip has not been encoded. This is also true for keys which are specially cut for the vehicle.

The vehicle keys or new spare keys can be obtained from a specialised CUPRA dealer or SEAT Official Service, a specialised workshop or an approved key service qualified to create this kind of key.

New keys or spare keys must be synchronised before use »» page 121.

CAUTION

All of the vehicle keys contain electronic components. Protect them from damage, impacts and humidity.

Note

- Only use the key button when you require the corresponding function. Pushing the button unnecessarily could accidentally unlock the vehicle or trigger the alarm. It is »

also possible even when you are outside the radius of action.

- Key operation can be greatly influenced by overlapping radio signals close to the vehicle working in the same range of frequencies, for example, radio transmitters or mobile telephones.
- Obstacles between the remote control and the vehicle, bad weather conditions and discharged batteries can considerably reduce the range of the remote control.
- If the buttons of the vehicle key are pressed >>> Fig. 108 or one of the central locking buttons >>> page 115 is pressed repeatedly in short succession, the central locking briefly disconnects as protection against overloading. The vehicle is then unlocked. Lock it if necessary.

Unlocking/Locking by remote control

Read the additional information carefully >>>  page 15

The vehicle will be locked again automatically if you do not open one of the doors or the rear lid within 30 seconds after unlocking the car. This function prevents the vehicle from remaining unlocked if the unlocking button is pressed by mistake. This does not apply if you press the  button for at least one second.

In vehicles with a **security central locking feature** (selective unlocking of side doors) >>> page 114, when the  button is pressed once, only the driver door and the fuel tank flap are unlocked. When the button is pressed a second time, all the vehicle doors are unlocked.

WARNING

Observe the safety warnings >>>  in Description on page 112.

Note

- Do not use the remote control key until the vehicle is visible.
- Other functions of the remote control key >>> page 127, Convenience opening and closing.

Selective unlocking system

The selective unlocking system allows you to only unlock the driver door and the fuel tank flap. All other doors and the rear lid remain locked.

Unlocking the driver door and tank flap

- Press (once) the  button on the remote control key or turn the key *once* in the opening direction.

Unlocking all the doors, the rear lid and the tank flap simultaneously.

- Within 5 seconds, press (twice) the  button on the remote control key, or turn the key *twice* within 5 seconds in the opening direction.

The anti-theft security system* and the anti-theft alarm* are immediately disabled if you unlock only the driver door, without unlocking the other doors.

In vehicles with Easy Connect*, you can programme the security central locking system directly >>> page 114.

Adjusting the central locking

You can use Easy Connect* to select which doors are unlocked with the central locking system. Using the radio or the Easy Connect* system, you can select whether the vehicle automatically closes with the “Auto Lock” programme at speeds of more than 15 km/h (9 mph).

Setting door unlocking

- Select the  button > SETTINGS function button > Opening and closing > Central locking > Unlocking doors.

Setting the Auto Lock

– Select: **CAR** button > **SETTINGS** function button > **Opening and closing** > **Central Locking** > **Locking while driving**.

Unlocking doors

You can choose to unlock **all** the doors or only the **driver door** when you unlock the vehicle. In **all** the options, the fuel tank flap is also unlocked.

With the **Driver** setting, when you press the  button on the remote control key once, only the driver door is unlocked. If that button is pressed twice, the rest of the doors and the rear lid will be unlocked.

In vehicles with a conventional key, turn the key in the door lock, in the direction of opening, twice within 2 seconds.

If the  button is pressed, all the vehicle doors are locked. At the same time, a confirmation signal* is heard.

Auto Lock while driving

If you select **on**, all the vehicle doors are locked at speeds above 15 km/h (9 mph).

Central locking switch

Read the additional information carefully
»  page 15

Please note the following when using the central locking switch to lock your vehicle:

- It is not possible to open the doors or the rear lid from the *outside* (for safety reasons, e.g. when stopped at traffic lights).
- The LED in the central locking switch lights up when all the doors are closed and locked.
- You can open the doors individually from the inside by pulling the inside door handle.
- In the event of an accident in which the airbags inflate, doors locked from the inside will be automatically unlocked to facilitate access and assistance.

WARNING

- The central locking switch also operates when the ignition is switched off and automatically locks all the vehicle doors when the  button is pressed.
- The central locking switch does not operate if the vehicle is locked from the outside and the anti-theft security system is switched on.
- Locked doors could delay assistance in an emergency, potentially putting lives at risk. Do not leave anyone, especially children, in the vehicle.

Note

Your vehicle will lock automatically when it reaches a speed of about 15 km/h (9 mph)

(Auto Lock) »» page 112. You can unlock the vehicle again using the  button on the central locking switch.

Unlocking and locking the vehicle with Keyless Access*

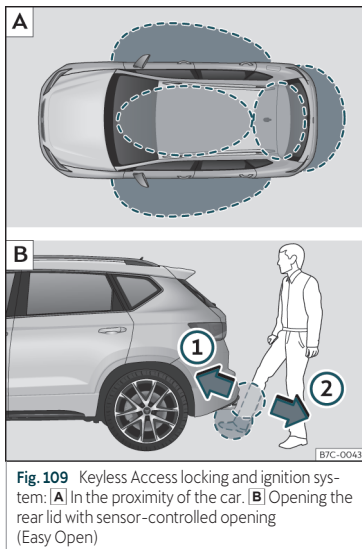

Fig. 109 Keyless Access locking and ignition system: **A** In the proximity of the car. **B** Opening the rear lid with sensor-controlled opening (Easy Open)

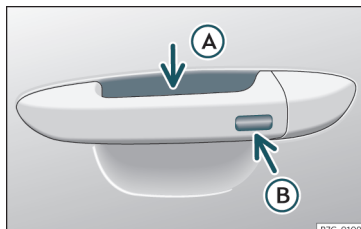

Fig. 110 Keyless Access locking and ignition system

- A** Unlocking sensor surface on the inside of the door handle
- B** Locking sensor surface on the outside of the door handle

Depending on the equipment, the vehicle may have the Keyless Access system.

Keyless Access is a key-free locking and ignition system to unlock and lock the vehicle without actively using its key. To do this, all that is required is to have a valid vehicle key in the detection area where you are attempting to access the vehicle >>> **Fig. 109 A** and to touch one of the sensor surfaces on the door handles >>> **Fig. 110** or operate the *soft-touch/handle* on the rear lid >>> **page 124** >>> **!**

The vehicle can be unlocked and locked via the front doors only. When doing so, the re-

mote control key must be no further than approx. 1.5 m away from the door handle.

It does not matter where you carry the key, for instance whether it is in your jacket pocket or in a briefcase.

Once the doors have been locked, they cannot be opened again immediately. This will enable you to check that the doors are properly closed.

If you wish, when unlocking, you can unlock *only* the corresponding door or the entire vehicle. The necessary adjustments can be performed in vehicles with a driver information system >>> **page 33**.

General information

If a valid key is in the proximity of the car, >>> **Fig. 109 A** the Keyless Access locking and starting system gives the key entry as soon as one of the sensor surfaces on the door handles is touched or the *softtouch/handle* on the rear lid is operated. The following features are then available without having to use the vehicle key actively:

- **Keyless Entry:** unlocking the vehicle using the handles of the front doors or the *soft-touch/handle* on the rear lid.
- **Keyless Exit:** locking the vehicle using the sensor of the driver or passenger door handle.

- **Easy Open:** opening the rear lid moving one foot below the rear bumper.
- **Press & Drive:** keyless starting of the engine with the starter button >>> page 214.

The central locking and locking systems operate in the same way as a *normal* locking and unlocking system. Only the controls change.

Unlocking the vehicle is confirmed with a *double* flash of the indicator lights; locking by a *single* flash.

If the vehicle is locked and then all doors and the rear lid are closed leaving the last key used inside the vehicle and none outside, the vehicle will **not** lock **immediately**. All the vehicle's indicator lights will flash *four times*. The vehicle will lock after a few seconds if you do not open any door or the rear lid.

The vehicle will lock again after a few seconds if you unlock the vehicle but fail to open any door or boot hatch.

Unlocking and opening the doors (Keyless-Entry)

- Grip one of the front door handles. In doing this, the sensor surface >>> Fig. 110 A (arrow) on the handle is touched and the vehicle unlocks.
- Open the door.

On vehicles with selective opening or information system configuration, pulling the door handle twice will unlock all doors.

In vehicles without safety system "Safelock": closing and locking the doors (Keyless-Exit)

- Switch the ignition off.
- Close the driver's door.
- Touch (*once*) the locking sensor surface B (arrow) on one of the front door handles. The door that is used must be closed.

In vehicles with a safety system "Safelock": closing and locking the doors (Keyless-Exit)

- Switch the ignition off.
- Close the driver's door.
- Touch (*once*) the sensor surface B (arrow) on one of the front door handles. The vehicle locks with the "Safelock" security system >>> page 120. The door that is used must be closed.
- Touch (*twice*) the sensor surface B (arrow) of one of the front door handles to lock the vehicle without activating the "Safelock" security system >>> page 120.

Unlocking and locking the boot hatch

When the vehicle is locked, the rear lid automatically unlocks on opening if there is a valid vehicle key in the proximity >>> Fig. 109 A.

Open or close the rear lid *normally*.

After closing, the hatch locks automatically. If the complete vehicle is unlocked, the rear lid will **not** lock automatically after closing it.

Rear lid with sensor-controlled opening/closing (Easy Open)

If there is a valid vehicle key in the proximity >>> Fig. 109 A of the rear lid, it is possible to unlock and open or close it moving one foot in the area of the sensors >>> Fig. 109 B located under the rear bumper.

- Switch the ignition off.
- Stand in front of the rear bumper, in the middle.
- With a brisk movement, bring your foot and lower leg as close as you can to the bumper. The lower part of the leg needs to be close to the upper sensor area and your foot to the lower sensor area >>> Fig. 109 B 1.
- Quickly remove your foot and lower leg from the sensor areas >>> Fig. 109 B 2. The rear lid will be automatically opened.
- If the rear lid fails to open, repeat the procedure after a few seconds.

>>

The third brake light flashes once to show the boot has opened with the Easy Open function.

The rear lid can be closed with another foot movement similar to the opening one (provided a valid vehicle key is in the proximity of the rear lid).

When closed, the rear lid automatically locks if the vehicle has been locked beforehand and there is no valid key inside.

While the rear lid is in motion (either opening or closing), it can be stopped with another foot movement similar to the opening one (provided a valid vehicle key is in the proximity of the rear lid).

The Easy Open feature is not available or only has limited availability in the following situations (examples):

- If the rear bumper is very dirty.
- If the rear bumper is wet with salt water, e.g. after having driven on gritted roads.
- If the electrical unlocking tow hitch is not covered.
- If the vehicle has been equipped at a later time with a tow bracket.

In the event of heavy rain, the Easy Open feature may take a little longer to open the boot or may deactivate automatically, to avoid the boot opening by accident, e.g. because of the running water.

The Easy Open function can be connected and disconnected permanently in the infotainment system by pressing the **CAR** button and the **SETTINGS > Opening and closing** function buttons >>>  page 33.

What happens when locking the vehicle with a second key

If there is a vehicle key inside the vehicle and it is locked from the outside with a second vehicle key, the key inside the vehicle is blocked for engine ignition >>> page 214. In order to enable engine ignition, press the  button on the key inside the vehicle.

Automatically disabling sensors

If the vehicle is not locked or unlocked for a long period of time, the proximity sensors on the passenger doors are automatically disabled.

If one of the sensor surfaces on the door handles is often activated in an unusual manner with the vehicle locked (e.g. by the branches of a bush rubbing against it), all proximity sensors are disabled for a certain period of time.



Sensors will again be enabled:

- After a time.
- **OR:** if the vehicle is unlocked with the button  on the key.
- **OR:** if the boot is opened.

- **OR:** if the vehicle is unlocked manually with the key.

Keyless Access temporary disconnection function*

You can deactivate the vehicle's Keyless Access unlocking for a locking and unlocking cycle.

- Move the gear lever to position **P** (if the vehicle has automatic gearbox), since otherwise the vehicle cannot be locked.
- Close the door.
- Push the central locking button  on the remote control and touch the locking sensor surface of the driver door handle >>> **Fig. 110**  within the following 5 seconds. Do not grasp the door handle; otherwise the vehicle will not unlock. Deactivation is also possible if the vehicle is locked through the driver's door lock.
- To check that the function has been deactivated, wait at least 10 seconds, grip and pull on the door handle. The door should not open.

The next time the door can only be unlocked via the remote control or the lock cylinder. The next time the door is locked/unlocked, Keyless Access will be active again.

Convenience functions

To close all the electric windows using the **convenience function**, keep a finger on the locking sensor surface **B** (arrow) of the door handle for a few seconds until the windows have closed.

The **doors opened** by touching the sensor surface of the door handle depend on the settings that have been activated in the infotainment system with the **CAR** > **SETTINGS** > **Opening and closing** function buttons.

WARNING

If there is a valid key in the proximity of the rear lid, in some cases the Easy Open function may be accidentally activated and the rear lid will open, for example, when sweeping under the rear bumper, when directing a water jet or high pressure steam to the area or when carrying out maintenance work or repairs in that area. If accidentally opened, the rear lid could injure somebody situated in its area of operation or cause material damage.

- Therefore, always make sure that there is no unsupervised valid key in the area near the rear lid.
- Before carrying out any maintenance or repair work on the vehicle, always disable the Easy Open feature via the infotainment system.

- Before washing the vehicle, always disable the Easy Open feature via the infotainment system.

- Before attaching a bicycle rack or a trailer, >>> page 296, always disable the Easy Open feature via the infotainment system.

CAUTION

The sensor surfaces on the door handles could engage if hit with a water jet or high pressure steam if there is a valid vehicle key in the proximity. If at least one of the electric windows is open and the sensor surface **B** (arrow) on one of the handles is activated continuously, all windows will close.

Note

- If the vehicle battery has little or no charge, or the vehicle key battery is almost or entirely out of charge, you will probably not be able to lock or unlock the vehicle with the Keyless Access system. The vehicle can be unlocked or locked manually >>> page 80.
- To control the proper locking of the vehicle, the release function is disabled for approx. 2 seconds.
- If the message **Keyless access system faulty** is displayed on the screen of the dash panel, abnormalities may occur in the operation of the Keyless Access system. Contact a specialised workshop. To do so,

CUPRA recommends going to a specialised CUPRA dealer or any SEAT dealership.

- Depending on the function set on the infotainment system for the mirrors, the exterior mirrors will unfold and the surround lighting will come on when unlocking the vehicle using the sensor surface on the driver and passenger door handles

>>> page 142.

- If there is no valid key inside the vehicle or the system fails to detect one, a warning will display on the dash panel screen. This could happen if any other radio frequency signal interferes with the key signal (e.g. from a mobile device accessory) or if the key is covered by another object (e.g. an aluminium case).
- If the sensors are very dirty, e.g. have a layer of salt, the correct functioning of the sensors on the door handles may be affected. In this case, clean the vehicle.
- If the vehicle is equipped with an automatic gearbox, it may only be locked in the gear stick is in position P.
- To improve the safety of your vehicle, the remote control of the system is equipped with a position sensor. If this remote control does not detect movement for a certain length of time, the system will conclude that the vehicle cannot be opened (e.g. on a night table) so it will be disabled.

Anti-theft security system (Safelock)*

The following message is displayed on the instrument panel to remind the driver that when the vehicle is closed from the outside, the anti-theft security system is switched on.

⚠ Do not forget the Safelock.

Please see Instruction Manual. The vehicle cannot be opened from inside. This makes it more difficult for unauthorised persons to break into the vehicle >>> **⚠** in Description on page 112.

The anti-theft security system can be switched off each time the vehicle is locked:

- Turn the key a second time to the lock position, in the door lock, **within two seconds**. If necessary, remove the protective cover on the driver door handle >>> **🔑** page 15 or
- Press the **🔒** button on the remote control for a second time **within 2 seconds**.

The flashing frequency of the diode in the door sill immediately confirms the process. Initially, the diode flashes in a fast sequence for a brief period, then it stops for approximately 30 seconds and, lastly continues flashing slowly.

Replacing the battery

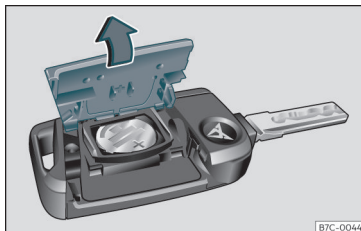

Fig. 111 Vehicle key: opening the battery compartment.

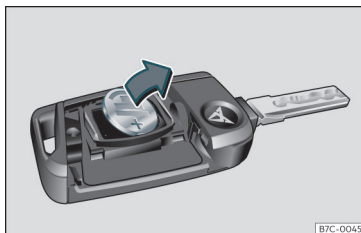

Fig. 112 Vehicle key: removing the battery.

CUPRA recommends you ask a specialised workshop to replace the battery.

The battery is located to the rear of the vehicle key, under a cover.

Changing the battery

- Unfold the vehicle key blade >>> page 113.
- Remove the cover from the back of the vehicle key >>> **Fig. 111** in the direction of the arrow >>> **ⓘ**.
- Extract the battery from the compartment using a suitable thin object >>> **Fig. 112**.
- Place the new battery in the compartment as shown >>> **Fig. 112**, pressing in the opposite direction to that shown by the arrow >>> **ⓘ**.
- Fit the cover as shown >>> **Fig. 111**, pressing it onto the vehicle key casing in the opposite direction to that shown by the arrow until it clicks into place.

ⓘ CAUTION



- If the battery is not changed correctly, the vehicle key may be damaged.
- Use of unsuitable batteries may damage the vehicle key. For this reason, always replace the dead battery with another of the same voltage, size and specifications.
- When fitting the battery, check that the polarity is correct.

♻ For the sake of the environment

Please dispose of your used batteries correctly and with respect for the environment.

Synchronising the vehicle key

If the  button is pressed frequently outside of the vehicle range, it is possible that the vehicle can no longer be locked or unlocked using the key. In this case, the key must be resynchronised as described below:

- Unfold the vehicle key blade >>> page 113.
- If necessary, remove the cover from the driver door lever >>>  page 15.
- Press the  button on the vehicle key. For this, it must remain with the vehicle.
- Open the vehicle within one minute using the key blade. The key has been synchronised.
- If necessary, fit the cap.

Childproof lock



Fig. 113 Childproof lock on the left hand side door.

The childproof lock prevents the rear doors from being opened from the inside. This system prevents minors from opening a door accidentally while the vehicle is running.

This function is independent of the vehicle electronic opening and locking systems. It only affects rear doors. It can only be activated and deactivated manually, as described below:

Activating the childproof lock

- Unlock the vehicle and open the door in which you wish to activate the childproof lock.
- With the door open, rotate the groove in the door using the ignition key, clockwise for the left hand side doors >>> **Fig. 113** and

anti-clockwise for the right hand side doors.

Deactivating the childproof lock

- Unlock the vehicle and open the door whose childproof lock you want to deactivate.
- With the door open, rotate the groove in the door using the ignition key, anti-clockwise for the left hand side doors >>> **Fig. 113** and clockwise for the right hand side doors.

Once the childproof lock is activated, the door can only be opened from the outside. The childproof lock can be activated or deactivated by inserting the key in the groove when the door is open, as described above.

Anti-theft alarm system*

Description

The anti-theft alarm makes it more difficult to break into the vehicle or steal it.

The anti-theft alarm is automatically turned on when the vehicle is locked with the key.

- The turn signal light will flash twice on opening and deactivating the alarm.

»

- The turn signal light will flash once on closing and activating the alarm.

When does the system trigger an alarm?

The anti-theft alarm siren will be triggered for about 30 seconds accompanied by sound and optical (flashing) warning signals and will be repeated about ten times when the vehicle is locked and the following unauthorised actions are attempted:

- Opening a door that is mechanically unlocked using the vehicle key without switching on the ignition in the next 15 seconds (in certain markets, such as the Netherlands, there is no 15 second waiting time and the alarm is activated immediately on opening the door).
- A door is opened.
- The bonnet is opened.
- The rear lid is opened.
- When the ignition is switched on with a non-authorised key.
- When the vehicle battery is disconnected.
- Movement inside the vehicle (in vehicles with interior monitoring >>> page 123).
- When the vehicle is towed (in vehicles with anti-tow system >>> page 123).
- When the vehicle is raised (in vehicles with anti-tow system >>> page 123).

- When the vehicle is transported on a ferry or by rail (vehicles with an anti-tow system or vehicle interior monitoring >>> page 123).
- When a trailer connected to the anti-theft alarm system is disconnected.

How to turn OFF the alarm

Unlock the vehicle with the unlocking button on the key or turn on the ignition with a valid key.

Note

- After 28 days, the indicator light will be switched off to prevent the battery from exhausting if the vehicle has been left parked for a long period of time. The alarm system remains activated.
- If, after the audible warning goes off, another monitored area is accessed (e.g. the rear lid is opened after a door has been opened), the alarm is triggered again.
- The anti-theft alarm is not activated when the vehicle is locked from within using the central locking button .
- If the driver door is unlocked mechanically with the key, only the driver door is unlocked, the rest of the doors remain locked. Only when the ignition has been turned on will the other doors be available - but not unlocked - and the central locking button will be activated.

- If the vehicle battery is run down or flat then the anti-theft alarm will not operate correctly.
- Vehicle monitoring remains active even if the battery is disconnected or not working for any reason.
- The alarm is triggered immediately if one of the battery cables is disconnected while the alarm system is active.

Vehicle interior monitoring and anti-tow system*

It is a monitoring or control function incorporated in the anti-theft alarm* which detects unauthorised vehicle entry by means of ultrasound.

Activation

- It is automatically switched on when the anti-theft alarm is activated.

Deactivation

- Open the vehicle with the key, either mechanically or by pressing the  button on the remote control. The time period from when the door is opened until the key is inserted in the contact should not exceed 15 seconds, otherwise the alarm will be triggered.

– Press the  button on the remote control twice. The volumetric sensor and tilt sensors will be deactivated. The alarm system remains activated.

The vehicle interior monitoring and the anti-tow system are automatically switched on again next time the vehicle is locked.

The vehicle interior monitoring and anti-tow sensor (tilt sensor) are automatically switched on when the anti-theft alarm is switched on. In order to activate it, all the doors and the rear lid must be closed.

If you wish to switch off the vehicle interior monitoring and the anti-tow system, it must be done each time that the vehicle is locked; if not, they will be automatically switched on.

The vehicle interior monitoring and the anti-tow system should be switched off if animals are left inside the locked vehicle (otherwise, their movements will trigger the alarm) or when, for example, the vehicle is transported or has to be towed with only one axle on the ground.

False alarms

Interior monitoring will only operate correctly if the vehicle is completely closed. Please observe related legal requirements.

The following cases may cause a false alarm:

- Open windows (partially or fully).

- Panoramic/tilting sunroof open (partially or completely).
- Movement of objects inside the vehicle, such as loose papers, items hanging from the rear vision mirror (air fresheners), etc.

Note

- **If the vehicle is relocked and the alarm is activated without the volumetric sensor function, relocking will activate the alarm with all its functions, except the volumetric sensor. This function is reactivated when the alarm is switched on again, unless it is deliberately switched off.**
- **If the alarm has been triggered by the volumetric sensor, this will be indicated by a flashing of the warning lamp on the driver door when the vehicle is opened. The flash is different to the flash indicating the alarm is activated.**
- **The vibration of a mobile phone left inside the vehicle may cause the vehicle interior monitoring alarm to trigger, as both sensors react to movements and shakes inside the vehicle.**
- **If on activating the alarm, any door or the rear lid is open, only the alarm will be activated. The vehicle interior monitoring and the anti-tow system will only be activated once all the doors are closed (including the rear lid).**

Deactivating the vehicle interior monitoring and anti-tow system*

When the vehicle is locked, the alarm will be triggered if movements are detected in the interior (e.g. by animals) or if the vehicle's inclination is changed (e.g. during transport). You can prevent the alarm from being triggered accidentally by switching off the vehicle interior monitoring and/or tow-away protection.

- To disconnect vehicle interior monitoring and anti-tow protection, switch off the ignition and use the infotainment system to select the following:  button > function button **SETTINGS > Open and close > Central locking > Vehicle interior monitoring**.
- When the vehicle is locked now, the vehicle interior monitoring and the tow-away protection are switched off until the next time the door is opened.

If the anti-theft security system (Safelock)* >>> page 120 is switched off, the vehicle interior monitoring and the tow-away protection are automatically switched off.

WARNING

Observe the safety warnings >>>  in Description on page 112.

Rear lid (luggage compartment)

Rear lid with electric opening and closing*

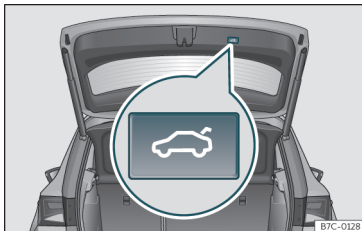



Fig. 114 Rear lid open: button to close rear lid immediately.







Fig. 115 Centre console: button to open and close rear lid.

Opening the rear lid

- Unlock the vehicle >>> page 112 and briefly press the handle of the rear lid. On vehicles with Keyless Access you can directly press the handle of the rear lid. The rear lid is unlocked if an authorised key is recognised in the proximity of the vehicle.
- **OR:** press the button on the centre console for at least one second >>> Fig. 115. The button also works when the ignition is switched off.
- **OR:** press and hold the  button of the vehicle key for approx. 1 second. If the vehicle is locked, only the rear lid is unlocked (the doors remain locked).
- **OR:** on vehicles with Keyless Access and sensor-controlled opening you can open the rear lid by moving one foot in the area of the sensors located below the rear bumper (Easy Open). The rear lid will be automatically opened.

Closing the rear lid

- Briefly press the  button on the rear lid >>> Fig. 114 >>> .
- **OR:** press the  button located on the centre console until the rear lid is closed >>> Fig. 115.
- **OR:** on vehicles with Keyless Access, press and hold the  vehicle key button until the rear lid is closed or move one foot in the area of the sensors located below the rear bump-

er (Easy Open) >>> page 116. The key of the vehicle must not be further away than 1.5 m from the boot or inside the vehicle.

- **OR:** manually move the rear lid in the direction of closing until it closes automatically.
- The rear lid goes down automatically to the final position and also closes automatically >>> .

Interrupting opening or closing

After beginning to open or close the rear lid, the action can be halted by pressing one of the  buttons.

Continue opening or closing the rear lid by hand. To do this, some force will have to be used.

If you press one of the  buttons again, the rear lid will move again in the original direction.

If the rear lid is met with resistance or an obstacle during the automatic opening or closing, opening or closing will be interrupted immediately. For the closing process, the rear lid opens again slightly.

- Check why it has not been possible to open or close the rear lid.
- Try to open or close the rear lid again.
- If necessary, the rear lid can be opened or closed by hand using reasonable force.

Special feature for pulling a trailer

If the factory-fitted towing bracket is electrically connected to a trailer »» page 296, the electric rear lid can only be opened or closed with the buttons on the rear lid itself.

Acoustic warnings

Throughout the process of opening or closing the rear lid, acoustic warnings can be heard. Exception: when the rear lid is opened manually using the handle or the Easy Open function with the movement of the foot or closed using the button on the rear lid itself »» Fig. 114.

Modifying and memorising the opening angle

If the space behind or above the vehicle is less than the travel area of the rear lid, you can change the opening angle of the rear lid.

To memorise a new opening angle, the rear lid must be open at least halfway.

- Interrupt the opening process in the desired position.
- Press the  button »» Fig. 114 on the rear lid for at least 3 seconds.

The opening angle is memorised. Memorisation is indicated by blinking of the hazard warning lights and an audible warning.

Resetting and memorising the opening angle

For the rear lid to reopen completely, the opening angle must be reset and memorised again.

- Release the rear lid and open it to the memorised height.
- Lift the rear lid by hand as far as it goes. To do this, some force will have to be used.
- Press the  button »» Fig. 114 on the rear lid for at least 3 seconds.
- This resets and memorises the factory-set opening angle. Memorisation is indicated by blinking of the hazard warning lights and an audible warning.

Automatic protection against overheating

If the system is operated repeatedly in a short space of time, it automatically switches off to prevent overheating.

Once the system is cool again, the function can be reused. Until then, the rear lid can only be opened and closed by hand using reasonable force.

If with the rear lid open the vehicle battery is disconnected »» page 318 or the corresponding fuse burns out »» page 85, the system will have to be reset. This requires closing the rear lid completely once.

Emergency unlocking

»»  page 17

WARNING

If a lot of snow builds up on the rear lid or it is heavily loaded, the rear lid may not open or, after opening, it may lower by itself due to the extra weight and cause serious injury.

- Do not open the rear lid when there is a lot of snow on it or when carrying a load (e.g. on a rack).
- Before opening the rear lid, remove the snow or the load.

WARNING

If the rear lid is closed incorrectly or without due care, it could result in serious injury.

- Never leave the vehicle unattended or allow children to play inside or next to it, especially if the rear lid is open. Children could enter the luggage compartment, close the rear lid and become trapped. A locked vehicle can reach extremely high and low temperatures, depending on the time of year, thus causing serious injuries, illness or even death.

CAUTION

Before opening or closing the rear lid, make sure that there is enough space to open or »

close it, e.g. when pulling a trailer or in a garage.

Rear lid automatic locking

Where the vehicle has been locked by pressing the  button on the remote control with the rear lid open, the rear lid will lock automatically when closed.

The automatic rear lid locking time extension function can be activated. Where this function is activated and once the rear lid has been unlocked by pressing the  button on the remote control key >>> page 114, the rear lid can be re-opened for a certain length of time.

Where required, the automatic tailgate locking time extension function can be activated or deactivated at an authorised service, which will provide all the necessary information.

Before the vehicle locks automatically, there is a risk of intruders getting into the vehicle. Therefore, we recommend you always lock the vehicle by pressing the  button on the remote control or by using the central locking button.

WARNING

Observe the safety warnings >>>  in Introduction on page 80.

- Always close the rear lid properly. Risk of accident or injury.

- The rear lid must not be opened when the reverse or rear fog lights are lit. This may damage the tail lights.

- Do not close the rear lid by pushing it down with your hand on the rear window. The glass could smash. Risk of injury!

- Ensure the rear lid is locked after closing it. If not, it may open unexpectedly while driving.

- Closing the rear lid without observing and ensuring it is clear could cause serious injury to you and to third parties. Make sure that no one is in the path of the rear lid.

- Never drive with the rear lid open or half-closed, exhaust gases may penetrate into the interior of the vehicle. Danger of poisoning!

- If you only open the rear lid, do not leave the key inside. The vehicle cannot be opened if the key is left inside.

Controls for the windows

Opening and closing the electric windows

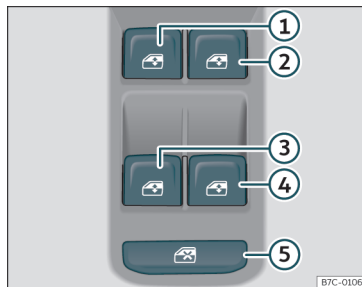



Fig. 116 Detail of the driver door: controls for the windows.

Read the additional information carefully >>>  page 18



The front and rear electric windows can be operated by using the controls on the driver door. The other doors each have a switch for their own window.

Always close the windows fully if you park the vehicle or leave it unattended >>> .

You can use the electric windows for approx. 10 minutes after switching off the ignition if neither the driver door nor the front

passenger door has been opened and the key has not been removed from the ignition.

Safety switch *



The safety switch  **Fig. 116**  on the driver door can be used to disable the electric window buttons on the rear doors.

Safety switch not pressed: buttons on rear doors are activated.

Safety switch pressed: buttons on rear doors are deactivated.

The safety control symbol  lights up in yellow if the buttons on the rear doors are switched off.

WARNING

Observe the safety warnings   in Introduction on page 80.

- Incorrect use of the electric windows can result in injury.
- Never close the rear lid without observing and ensuring it is clear, to do otherwise could cause serious injury to you and third parties. Make sure that no one is in the path of a window.
- If the ignition is switched on, the electric equipment could be activated with risk of injury, for example, in the electric windows.
- The doors can be locked using the remote control key. This could become an

obstacle for assistance in an emergency situation.

- Therefore always take the key with you when you leave the vehicle.
- The electric windows will work until the ignition has been switched off and one of the front doors has been opened.
- If necessary, use the safety switch to disable the rear electric windows. Make sure that they have been disabled.

Note

If the window is not able to close because it is stiff or because of an obstruction, the window will automatically open again  page 127. If this happens, check why the window could not be closed before attempting to close it again.

Roll-back function



The roll-back function reduces the risk of injury when the electric windows close.

- If a window is obstructed when closing automatically, the window stops at this point and lowers immediately .
- Next, check why the window does not close before attempting it again.
- If you try within the following 10 seconds and the window closes again with difficulty or

there is an obstruction, the automatic closing will stop working for 10 seconds.

- If the window is still obstructed, the window will stop at this point.
- If there is no obvious reason why the window cannot be closed, try to close it again by pulling the tab within ten seconds. The window closes with maximum force. **The roll-back function is now deactivated.**
- If more than 10 seconds pass, the window will open fully when you operate one of the buttons. One-touch closing is reactivated.

WARNING



Observe the safety warnings   in Opening and closing the electric windows on page 127.

- The roll-back function does not prevent fingers or other parts of the body getting pinched against the window frame. Risk of accident.



Convenience opening and closing

Use the convenience opening/closing function to easily open/close all the windows from the outside. »

Convenience open function

- Press and hold the  button on the remote control key until all the windows have reached the desired position, or
- First unlock the vehicle using the  button on the remote control key and then keep the key in the driver door lock until all the windows have reached the required position.

Convenience close function

- Press and hold the  button on the remote control key until all the windows are closed >>> , or
- Lock the driver's door with the key and hold the key in the lock position until all the windows are closed

Programming convenience opening in the Easy Connect*

- Select:  button > **SETTINGS function button** > **Opening and closing** > **Opening the window by holding down button** or > **Front window on/off**.

WARNING

- Never close the windows without due care or proper control. There is a risk of suffering injury.
- For safety reasons, you should only use the remote control open and close func-

tions within about 2 metres of the vehicle. To avoid injuries, always keep an eye on the windows when pressing the button to close them. The windows stop moving as soon as the button is released.

One-touch opening and closing

One-touch opening and closing means you do not have to hold down the button.

Buttons >>> **Fig. 116** ①, ②, ③ and ④ have two positions for opening windows and two for closing them. This makes it easier to open and close windows to the desired position.

One-touch closing

- Pull up the window button briefly up to the second position. The window closes fully.

One-touch opening

- Push down the window button briefly up to the second position. The window opens fully.

Resetting one-touch opening and closing

The automatic open and close function will not work if the battery has been temporarily disconnected. The function can be restored as follows:

- Close the window as far as it will go by lifting and holding the electric window switch.
- Release the switch and then lift it again for 1 second. This will re-enable the automatic function.

If you push (or pull) a button to the first stage, the window will open (or close) until you release the button. If you push or lift the button briefly to the second stage, the window will open (one-touch opening) or close (one-touch closing) automatically. If you operate the button while the window is opening or closing, it stops at this position.

Sunroof*

Introduction

The sunroof consists of two glass parts. The rear part is fixed and cannot be opened. It also has a sun blind.

WARNING

If the sunroof is used negligently or without paying due attention, it can cause serious injury.

- Open or close the sunroof and the sun blind only when no one is in their path of movement.

- Never leave any key inside the vehicle when exiting.
- Never leave a child or any other person who may need help in the vehicle, especially if they have access to the vehicle key. If using the key unattended, they could lock the vehicle, start the engine, switch on the ignition and activate the sunroof.
- After switching off, it is still possible to open or close the sunroof during a short space of time provided that neither the driver nor passenger door is opened.

ⓘ CAUTION

- To prevent damage, during winter temperatures remove any ice or snow that might be on the car roof before opening the sunroof or adjusting the tilt position.
- Before leaving the vehicle or in case of rainfall, always close the sunroof. With the sunroof open or in a tilted position, water can enter the interior and can cause considerable damage to the electrical system. As a result, other damage can occur in the vehicle.

ℹ Note

- Leaves and other loose objects that accumulate on the sunroof rails should be regularly cleaned away either by hand or with a vacuum.

- If the sunroof does not work correctly, the anti-trap function will not work either. Contact a specialised workshop.

Opening and closing the sunroof

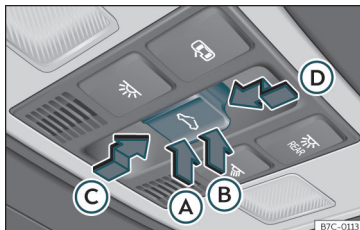

Fig. 117 On the interior roof lining: sunroof button.

The sunroof only works when the ignition is switched on. Once the ignition has been switched off, you can still open or close the sunroof for a few minutes provided the driver door and the front passenger door are not opened.

The sun blind automatically opens along with the sunroof if completely closed or if in front of the sunroof. The sun blind remains in the previous position and does not automatically close with the sunroof. The sun blind can only be closed completely once the sunroof has been closed.

The button **Fig. 117** has two levels. The first level switches the sunroof to the tilted position, opening or closing it fully or partially.

On the second level, the sunroof automatically moves to the corresponding final position after briefly pressing the button. Activating the button again stops the automatic function.

Adjusting the tilt position of the sunroof

- Press the rear part of the button **(B)** to the first level.
- Automatic function: briefly press the rear part of button **(B)** to the second level.

Closing the sunroof from a tilted position

- Press the front part of the button **(A)** to the first level.
- Automatic function: briefly press the front part of the button **(A)** to the second level.

Stopping the automatic operation by adjusting the tilted position of the sunroof or by closing the sunroof

- Press button **(A)** or **(B)** again.

Opening the sunroof

- Press button **(C)** backwards to the first level. »

- Automatic function to the comfort position: briefly press button **(C)** backwards to the second level.

Closing the sunroof

- Press button **(D)** forwards to the first level.
- Automatic function: briefly press button **(D)** forwards to the second level.

Stopping the automatic operation during the opening or closing

- Press button **(C)** or **(D)** again.

Opening and closing the sun blind

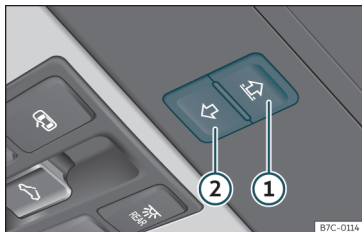

Fig. 118 On the interior roof lining: switches for the sun blind.

The electrical sun blind works when the ignition is switched on.

When the sunroof is in its most tilted position, the sun blind automatically goes into a ventilation position. The sun blind remains in this position also with the sunroof closed.

Buttons **>>> Fig. 118 (1)** and **(2)** have two levels. The first level opens or closes the sun blind fully or partially.

By briefly pressing the button to the second level, the sun blind automatically moves to the corresponding final position. Activating the button again stops the automatic function.

Once the ignition has been switched off, you can still open or close the sun blind for a few minutes provided the driver door and the front passenger door are not opened.

Opening the sun blind

- Press button **(1)** to the first level.
- Automatic function: briefly press button **(1)** to the second level.

Closing the sun blind

- Press button **(2)** to the first level.
- Automatic function: briefly press button **(2)** to the second level.

Stopping the automatic operation during the opening or closing

- Press button **(1)** or **(2)** again.

Note

When the sunroof is open, the electric sun blind can only be closed to the front edge of the sunroof.

Convenience function to open or close the sunroof*

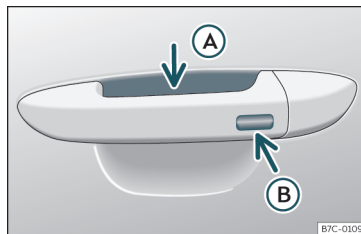

Fig. 119 Driver door lever: sensor surfaces.

The sunroof can be opened and closed with the convenience function, just like the windows.

Using the door lock*

- Hold the key in the door lock of the driver door in either the unlocking or locking position to open or close the roof in the tilted position. Release the key to interrupt this function.

Using the remote control

- Keep the locking/unlocking button pressed to open/close the roof. If you release the button the opening/closing will stop.

Using the Keyless Access* system (only closing)

- Press and hold the locking sensor surface >>> **Fig. 119**  on the door handle to close the sunroof. If you release the sensor surface, the closing movement stops.

WARNING

If the sunroof is used negligently or without paying due attention, it can cause serious injury.

Anti-trap function of the panoramic sliding sunroof and the sun blind



The anti-trap function can reduce the risk of injury when closing the sunroof and the sun blind >>> . If the sunroof or sun blind encounter resistance or an obstacle when closing, they reopen immediately.

- Check why the sunroof or sun blind do not close.
- Try to close the sunroof or sun blind again.
- If the sunroof or sun blind cannot be closed due to an obstacle or some resist-

ance, it stops at the corresponding position and then opens. For automatic closing, a new closing attempt might take place.

- If the sunroof or sun blind is still unable to close, close it without the anti-trap function.

Closing the sunroof or sun blind without the anti-trap function

- *Sunroof*: within approximately 5 seconds of having activated the roll-back function, press the  button >>> **Fig. 117** to the second level in the direction of arrow >>> **Fig. 117**  until the sunroof closes completely.
- *Sun blind*: within approximately 5 seconds of having activated the anti-trap function, press button >>> **Fig. 118**  until the sun blind closes completely.
- **The sunroof or sun blind close without the anti-trap function intervening!**
- If the sunroof or sun blind will still not close, visit a specialised workshop.

WARNING

Closing the sunroof or sun blind without the anti-trap function can cause serious injuries.

- Always be careful when closing the sunroof and sun blind.
- No person should ever remain in the way of the sunroof or sun blind, especially when closing without the anti-trap function.

- The anti-trap function does not prevent fingers or other parts of the body from becoming trapped against the roof frame and injuries occurring.

Lights and visibility

Lights

Control lamps

It lights up

Driving light totally or partially faulty.

Fault in the cornering light system.

It lights up

Rear fog light switched on >>> page 135.

It lights up

Left or right turn signal.
The control lamp flashes twice as fast when a turn signal is faulty.

Hazard warning lights on >>> page 136.

It lights up

Trailer turn signals

It lights up

Main beam on or flasher on >>> page 133.

It lights up

The Light Assist system is on >>> page 134.

Several warning and control lamps light up for a few seconds when the ignition is switched on, signalling that the function is being verified. They will switch off after a few seconds.

WARNING

Observe the safety warnings >>>  in Control and warning lamps on page 109.



Side light and dipped beam headlight

Read the additional information carefully >>>  page 30

The driver is personally responsible for the correct use and adjustment of the lights in all situations.

Audible warnings to advise the driver that the lights have not been switched off

If the key is not in the ignition and the driver door is open, an audible warning signal is heard in the following cases: this will remind you to turn the light off.

- When the parking light is on >>> page 133.
- When the light switch is in position  or .

WARNING

The side lights or daytime running lights are not bright enough to illuminate the road ahead and to ensure that other road users are able to see you.

- Always use your dipped beam head lights if it is raining or if visibility is poor.

WARNING

If the headlights are set too high and not used correctly, there is a risk of dazzling or distracting other road users. This could result in a serious accident.

- Always make sure that the headlights are correctly adjusted.

Note

The legal requirements regarding the use of vehicle lights in each country must be observed.

Daytime running lights

The daytime running lights consist of individual lights, integrated in the front headlights. When the daytime running lights are switched on, the rear side light also switches on >>> .

The daytime running lights switch on every time the ignition is switched on, if the switch

is in positions **0** or **AUTO**, according to the level of exterior lighting.

When the light switch is in position **AUTO**, a light sensor automatically switches dipped beam on and off (including the control and instrument lighting) or the daytime running lights depending on the level of exterior lighting.

WARNING

- Never drive with daytime lights if the road is not well lit due to weather or lighting conditions. Daytime lights do not provide enough light to illuminate the road properly or be seen by other road users.
- A vehicle which does not have the rear lights on may not be visible to other drivers in the darkness, in the case of heavy rain or in conditions of poor visibility.

Turn signal and main beam lever



Read the additional information carefully
»  page 31

Push the lever all the way down to turn off the corresponding function.

Convenience turn signals

For the one-touch signalling, when the ignition is switched on, move the lever as far as possible upwards or downwards and release

the lever. The turn signal will flash three times.

One-touch signalling is activated and deactivated in the Easy Connect system via the  button and the function button **SETTINGS > Lights > One-touch signalling**
»  page 33.

In vehicles that do not have the corresponding menu, this function can be deactivated in a specialised workshop.

WARNING

Improper or lack of use of the turn signals, or forgetting to deactivate them can confuse other road users. This could result in a serious accident.

- Always give warning when you are going to change lane, overtake or when turning, activating the turn signal in good time.
- As soon as you have finished changing lane, overtaking or turning, switch the turn signal off.

WARNING

Incorrect use of the headlights may cause accidents and serious injury, as the main beam may distract or dazzle other drivers.

Note

- If the convenience turn signals are operating (three flashes) and the other conven-

ience turn signals are switched on, the active part stops flashing and only flashes once in the new part selected.

- The turn signal only works when the ignition is switched on. The hazard warning lights also work when the ignition is switched off.
- If a trailer turn signal malfunctions, the control lamp will stop flashing (trailer turn signals) and the vehicle turn signal will flash at double speed.
- The *main beam headlights* can only be switched on if the dipped beam headlights are already on.
- In cold or damp weather conditions, the headlights, tail lights and turn signals may mist up inside temporarily. This is normal and in no way effects the useful life of the vehicle lighting system.

Automatic dipped beam control **AUTO***

The automatic dipped beam control is merely intended as an aid and is not able to recognise all driving situations.

When the light switch is in position **AUTO**, the vehicle lights and the instrument panel and switch lighting switch on and off automatically in the following situations »  In Day-time running lights on page 133: »

Automatic switching on	Automatic switching off
The photo sensor detects <i>darkness</i> , for example, when driving through a tunnel.	When adequate lighting is detected.
The rain sensor detects rain and activates the windscreen wipers.	When the windscreen wipers have been inactive for a few minutes.

WARNING

If the road is not well lit and other road users cannot see the vehicle well enough or at all, accidents may occur.

- The automatic dipped beam control (AUTO) only switches on the dipped beam when there are no changes in brightness, and not, for example when it is foggy.

Main beam assist (Light Assist)*



The main beam assist acts within the limits of the system and depending on environmental and traffic conditions. Once switched on, the system is activated as of a speed of about 60 km/h (37 mph) and is deactivated below about 30 km/h (18 mph) >>> .

When the system is activated and the camera detects other vehicles that may be dazzled, the main beam is automatically switch-

ed off. Otherwise, the main beam is automatically switched on.

The main beam assist generally detects illuminated areas and deactivates the main beam when passing through a town, for example.

Switching the main beam assist on and off

Function	Use
Activate: 	<ul style="list-style-type: none"> – Switch the ignition on and turn the light switch to position AUTO. – From the base position, move the main beam and turn signal lever forwards >>> page 133. When the warning lamp  is displayed on the instrument panel display, the main beam assist is switched on.
Deactivate:	<ul style="list-style-type: none"> – Turn the light switch to a different position to AUTO >>> page 132. – OR: with main beam on, move the turn signal and main beam lever backwards. – OR: move the turn signal and main beam lever forward to manually enable the main beam. The main beam assist will then be deactivated.

Malfunctions

The following conditions may prevent the main beam headlight control from turning off the headlights in time or from turning off altogether:

- In poorly lit towns with highly reflective signs.
- Other insufficiently lit road users (such as pedestrians or cyclists).
- On tight bends and steep slopes (bumps) and when oncoming vehicles are partially obscured.
- When the drivers of other oncoming vehicles (such as a truck) can see over a guard rail in the centre of the road.
- If the camera is damaged or the power supply is cut off.
- In fog, snow and heavy rain.
- With dust and sand turbulence.
- With loose gravel in the field of vision of the camera.
- When the field of vision of the camera is misted up, dirty or covered by stickers, snow, ice, etc.

WARNING

The convenience features of the main beam assist should not encourage the taking of risks. The system is not a replacement for driver concentration.

- You are always in control of the main beam and adapting it to the light, visibility and traffic conditions.
- It is possible that the main beam headlight control does not recognise all driving

situations and is limited under certain circumstances.

- When the field of vision of the camera is dirty, covered or damaged, operation of the main beam control may be affected. This also applies when changes are made to the vehicle lighting system, for example, if additional headlights are installed.

⚠ CAUTION

To avoid affecting the operation of the system, take the following points into consideration:

- Clean the field of vision of the camera regularly and make sure it is free of snow and ice.
- Do not cover the field of vision of the camera.
- Check that the windscreen is not damaged in the area of the field of vision of the camera.

i Note

Main beam and headlight flasher can be turned on and off manually at any time with the turn signal and main beam lever >>> page 133.

Fog lights



Fig. 120 Instrument console: light panel.

The fog lights can be switched on when the light panel is in the **AUTO** (side light) or **D** (dipped beam) and the engine is running.

- **Switching on the rear fog light** (☼): pull on the light switch until it engages >>> Fig. 120 ①. The ☼ indicator light will appear in the instrument panel.
- To switch off the fog lights, press the light switch in or turn it to position **0**.

i Note

The rear fog light can dazzle drivers behind you. You should use the rear fog light only when visibility is very poor.

“Coming home” function

This function may be connected/disconnected through the radio menu. The “Coming Home” and/or “Leaving Home” delay time may also be set (default: 30 sec).

In the “Coming Home” function, the dipped beams, the daytime running lights (DRL), the rear side lights, the number plate lights and the courtesy lights in the rear view mirror (Welcome Light) switch on.

Automatic* activation of “Coming Home”

For vehicles with a light and rain sensor (rotary light switch in position **AUTO**).

- Switch off the engine and remove the key from the ignition with the rotary light switch in position **AUTO** >>> page 30.
- The automatic “Coming Home” function is only active when the light sensor detects darkness.
- When the car door is opened, the “Coming Home” lighting comes on.

Manual “Coming Home” activation

For vehicles with a light and rain sensor (rotary light switch without position **AUTO**).

- Switch off the engine and remove the key from the ignition. >>>

- Activate the headlight flashers for approximately 1 second.
- Activated for any position of the rotary light switch.
- When the car door is opened, the “Coming Home” lighting comes on. The headlights are turned off 60 seconds after the vehicle door is opened.

Deactivation

- If no door has been closed, they go out automatically after 60 seconds.
- After the last door has been closed, the headlights will be switched off after the “Coming Home” delay (as established in the radio menu) has elapsed.
- On turning the light switch to position 0 >>>  page 30.
- When the ignition is switched on (when starting the engine).

Function “Leaving Home”

The “Leaving Home” function is only available for vehicles with a light and rain sensor (rotary light switch in position **AUTO**).

This function may be connected/disconnected through the radio menu. The “Leaving Home” function switch-off delay may also be set (default: 30 sec).

In the “Leaving Home” function, the dipped beams, the daytime running lights (DRL), the rear side lights, the number plate lights and the courtesy lights in the rear view mirror (“Welcome Light”) switch on.

Activation

- When the vehicle is unlocked using the remote control.
- The “Leaving Home” function is only activated when the rotary light switch is in position **AUTO** and the light sensor detects darkness.

Deactivation

- When the “Leaving Home” delay period ends (default: 30 sec).
- When the vehicle is locked using the remote control.
- When the light control is switched into a position other than **AUTO**.
- With the ignition is switched on.

Hazard warning lights

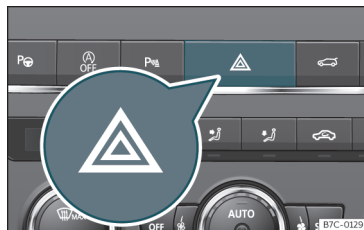



Fig. 121 Dashboard: switch for hazard warning lights.



Read the additional information carefully
>>>  page 31

The hazard warning lights are used to draw the attention of other road users to your vehicle in emergencies.

If your vehicle breaks down:

1. Park your vehicle at a safe distance from moving traffic.
2. Press the button to switch on the hazard warning lights >>> .
3. Switch the ignition off.
4. Apply the handbrake.
5. Move the selector lever to position **P**.

- Use the warning triangle to draw the attention of other road users to your vehicle.
- Always take the vehicle key with you when you leave the vehicle.

All turn signals flash simultaneously when the hazard warning lights are switched on. The two turn signal turn signal lamps  and the turn signal lamp in the switch  will flash at the same time. The simultaneous hazard warning lights also work when the ignition is switched off.

Emergency braking warning

If the vehicle brakes suddenly and continuously at a speed of more than 80 km/h (50 mph), the brake light flashes several times per second to warn the vehicles driving behind. If you continue braking, the hazard warning lights will come on automatically when the vehicle comes to a standstill. They switch off automatically when the vehicle starts to move again.

WARNING

- The risk of an accident increases if your vehicle breaks down. Always use the hazard warning lights and a warning triangle to draw the attention of other road users to your stationary vehicle.
- Due to the high temperatures that the catalytic converter can reach, never park in

an area where the catalytic converter could come into contact with highly inflammable materials, for example dry grass or spilt petrol. This could start a fire.

Note

- The battery will run down if the hazard warning lights are left on for a long time, even if the ignition is switched off.
- The use of the hazard warning lights described here is subject to the relevant statutory requirements.

Parking lights

When the parking light is switched on, (right or left turn signal), the front side light and the rear light on the corresponding side of the vehicle stay lit. The parking lights can only be activated with the ignition switched off and the turn signal and main beam lever in the central position, before being triggered.

Parking light on both sides

With the ignition switched off and the light switch in position , when locking the vehicle from the outside, the parking lights on both sides of the vehicle light up. In doing so, only the side lights of both headlights light

up, and additionally the tail lights will do so partially.

Motorway light*

The function is connected/disconnected via the corresponding Easy Connect system menu.

- Activation:** when going above 110 km/h (68 mph) for more than 30 seconds, the dipped beam raises slightly to increase the driver's visibility distance.
- Deactivation:** when reducing the speed of the car below 100 km/h (62 mph), the dipped beam returns to its normal position.

Driving abroad

The light beam of the dipped beam lights is asymmetric: the side of the road on which you are driving is lit more intensely.

When a car that is manufactured in a country that drives on the right travels to a country that drives on the left (or vice versa), it is normally necessary to cover part of the headlight bulbs with stickers or to change the adjustment of the headlights to avoid dazzling other drivers.

In such cases, the regulations specify certain light values that must be complied with for 

designated points of the light distribution. This is known as “Tourist light”.

The light distribution of the halogen and full-LED headlights allows the specific “tourist light” values to be met without the need for stickers or changes in the settings.

Note

“Tourist light” is only allowed temporarily. If you are planning a long stay in a country that drives on the other side, you should take the vehicle to an Authorised Technical Service to change the headlights.

Dynamic adjustment of headlight range

The headlight range is automatically adjusted according to the vehicle load status when they are switched on.

WARNING

Heavy objects in the vehicle may mean that the headlights dazzle and distract other drivers. This could result in a serious accident.

- Adjust the light beam to the vehicle load status so that it does not blind other drivers.

Lighting of the instrument panel, screens and controls

Depending on the model, the lighting of the instrument panel and controls can be adjusted in the Easy Connect system, using the **CAR** button and the **SETTINGS** function button >>>  page 33.

In certain cases, when the engine is running and the lights are not switched on; e.g., passing through a tunnel without having activated the **AUTO** function, a **Switch on the Lights** warning will appear on the instrument panel.

Interior and reading lights¹⁾

Read the additional information carefully >>>  page 32

Glove compartment and luggage compartment lighting*

When opening and closing the glove compartment on the front passenger side and the rear lid, the respective light will automatically switch on and off.

Footwell lighting*

The lights in the footwell area below the dash (driver and front passenger sides) will switch on when the doors are opened and will decrease in intensity while driving. The intensity of these lights can be adjusted using the radio menu (see **Easy Connect > Light Settings > Interior Lighting** >>>  page 33).

Ambient light*

The ambient light lights up the area of the centre console, the footwell area and, depending on the version, the front door panels.

The ambient lighting in the door panels may change colour. The brightness and colour of these lights can be adjusted using the radio

¹⁾ Depending on the features fitted in the vehicle, LEDs can be used for the following interior lights: front vanity mirror light, rear vanity mirror light, footwell light, sun blind and glove compartment light.

menu (see **Easy Connect > Light Settings > Interior lighting** >>>  page 33).

Note

The reading lights switch off when the vehicle is locked using a key or after several minutes if the key is removed from the ignition. This prevents the battery from discharging.

Visibility

Sun visors

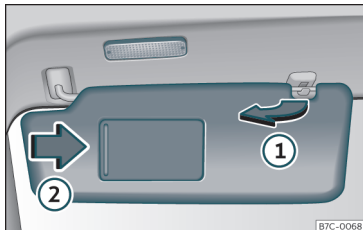



Fig. 122 Sun visor

Options for adjusting driver and front passenger sun visors:

- Lower the sun visor towards the windscreen.

- The sun visor can be pulled out of its mounting and turned towards the door >>> **Fig. 122** .

- Swing the sun visor towards the door, longitudinally backwards.

Vanity mirror light

There may be a vanity mirror, with a cover, on the rear of the sun visor. When the cover is opened  a light comes on.

The lamp goes out when the vanity mirror cover is closed or the sun visor is pushed back up.

WARNING

Folded sun blinds can reduce visibility.

- Always store sun blinds and visors in their housing when not in use.

Note

The light above the sun visor automatically switches off after a few minutes in certain conditions. This prevents the battery from discharging.

Windscreen wiper and window wiper systems

Window wiper lever

Read the additional information carefully >>>  page 32

CAUTION

If the ignition is switched off with the windscreen wipers active, they complete their wipe before returning to the rest position. When switching the ignition back on, the windscreen wiper will continue to operate at the same wiping level. Ice, snow and other obstacles on the windscreen may damage the wiper and the windscreen wiper motor.

- If necessary, remove snow and ice from the windscreen wipers before starting your journey.
- Carefully lift the frozen windscreen wipers from the glass. CUPRA recommends a de-icer spray for this operation.
- Do not switch on the windscreen wipers if the windscreen is dry. Cleaning with the windscreen wipers while dry can cause damage.
- In icy conditions, always check that the wiper blades are not frozen to the glass before using the wipers. In cold weather, it may help to leave the vehicle parked with

the wipers in service position

>>>  page 54.

Note

- The windscreen and window wipers only function when the ignition is switched on and the bonnet or rear lid, respectively, are closed.
- The interval wipe speed varies according to the vehicle speed. The faster the vehicle is moving, the more often the windscreen is cleaned.
- The rear wiper is automatically switched on when the windscreen wiper is on and the car is in reverse gear.

Windscreen wiper functions

Windscreen wipers performance in different situations

If the vehicle is at a standstill	The activated position provisionally changes to the previous position.
During automatic wipe	The air conditioner comes on for approximately 30 seconds in air recirculation mode to prevent the smell of the windscreen washer fluid entering the inside the vehicle.

Windscreen wipers performance in different situations

For the interval wipe	Intervals between wipes depend on the vehicle's speed. The higher the vehicle speed the shorter the intervals.
-----------------------	--

Heated windscreen washer jets*

The heating only thaws the frozen jets, it does not thaw the water in the washer hoses. When the ignition is switched on the heated windscreen washer jets automatically adjust the heat depending on the ambient temperature.

Headlight wash/wipe system*

The headlight washers/wipers clean the headlight lenses.

After the ignition is switched on, the first and every fifth time the windscreen washer is switched on, the headlights are also washed. Therefore, the windscreen wiper lever should be pulled towards the steering wheel when the dipped beam or main beam are on. Any encrusted dirt (such as insects) should be cleaned regularly (e.g. when refuelling).

To ensure the headlight washers work correctly in winter, any snow which has got into the bumper jet supports should be cleaned away. If necessary, remove snow with an anti-icing spray.

Note

The wiper will try to wipe away any obstacles that are on the windscreen. The wiper will stop moving if the obstacle blocks its path. Remove the obstacle and switch the wiper back on again.

Rain sensor

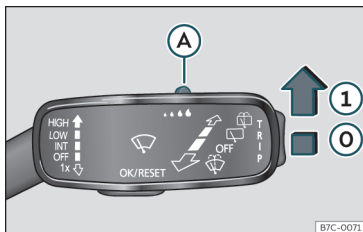

Fig. 123 Windscreen wipers lever: adjust the rain sensor (A).

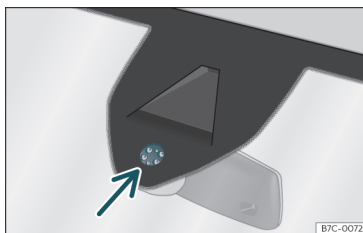

Fig. 124 Rain sensor sensitive surface

The rain sensor controls the frequency of the windscreen wiper intervals, depending on the amount of rain >>> **⚠**. The sensitivity of the rain sensor can be adjusted manually. Manual wipe >>> page 139.

Move the lever to the required position

>>> **Fig. 123**:

- ⊖ Rain sensor off.
- ① Rain sensor on; automatic wipe if necessary.
- Ⓐ Setting sensitivity level of rain sensor
 - Set control to the right: high sensitivity.
 - Set control to the left: low sensitivity.

When the ignition is switched off and then back on, the rain sensor stays on and starts operating again when the windscreen wipers are in position ① and the vehicle is travelling at more than 16 km/h (10 mph).

Rain sensor modified behaviour

Possible causes of faults and mistaken readings on the sensitive surface >>> **Fig. 124** of the rain sensor include:

- Damaged wipers: a film of water on the damaged blades may lengthen the activation time, reduce the washing intervals or result in a fast and continuous wipe.
- Insects: insects on the sensor may trigger the windscreen wiper.
- Salt on the road: in winter, salt spread on the roads may cause an extra long wipe when the windscreen is almost dry.
- Dirt: dry dust, wax, coating on glass (Lotus effect) or traces of detergent (car wash) may

reduce the effectiveness of the rain sensor or make it react more slowly, later or not at all.

- Windscreen crack: the impact of a stone will trigger a single wipe cycle with the rain sensor on. Next the rain sensor detects the reduction in the sensitive surface area and adapts accordingly. The behaviour of the sensor will vary with the size of the damage caused by the stone.

⚠ WARNING

The rain sensor may not detect enough rain to switch on the wipers.

- If necessary, switch on the wipers manually when water on the windscreen obstructs visibility.

i Note

- Clean the sensitive surface of the rain sensor regularly and check the blades for damage >>> **Fig. 124** (arrow).
- To remove wax and coatings, we recommend a window cleaner containing alcohol.

Mirror

Anti-dazzle rear view mirror

It is dangerous to drive if you cannot see clearly through the rear window.

Rear view mirror with automatic anti-dazzle function*

The anti-dazzle function is activated every time the ignition is switched on.

When the anti-dazzle function is enabled, the interior rear vision mirror will darken **automatically** according to the amount of light it receives. The anti-dazzle function is cancelled if reverse gear is engaged.

⚠ WARNING

In the event that an automatic anti-dazzle rear vision mirror breaks, an electrolyte fluid may leak. This could cause irritation to the skin, eyes and respiratory organs. If you come into contact with this liquid, it must be rinsed with large quantities of water. If necessary, get medical help.

⚠ CAUTION

In the event that an automatic anti-dazzle rear vision mirror breaks, an electrolyte fluid may leak. This liquid attacks plastic surfaces. Clean it with a wet sponge as soon as possible.

i Note

- If the light incident in the interior rear vision mirror is obstructed (e.g. with the sun blind*), the anti-dazzle rear vision mirror with automatic setting will not operate perfectly.
- When the interior lights are on or reverse gear engaged, the mirrors do not darken with automatic adjustment for anti-dazzle position.

Adjusting the exterior rear-view mirrors

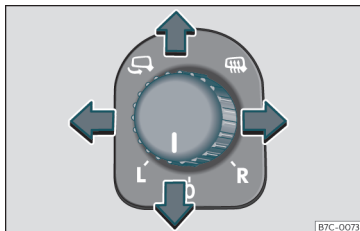

Fig. 125 Driver door: control for the exterior mirror.

Read the additional information carefully
 >>> page 20

Synchronized regulation of the exterior mirrors

- In the **Settings - Convenience** menu, select whether or not the exterior mirrors should move in synchronisation.
- Turn the knob to position **L**¹⁾.
- Adjust the left-hand exterior mirror. The right exterior mirror will be adjusted at the same time (synchronised).

¹⁾ Regulation in right-hand drive vehicles is symmetrical.

- If necessary, correct the right-hand rear-view mirror: rotate the control to position **R**¹⁾.
- In the Easy Connect system the exterior mirrors can be adjusted using the **CAR** button and the **SETTINGS** function button.

Fold the rearview mirrors when locking the vehicle*

The Easy Connect system, the **CAR** > **SETTINGS** > **Mirrors and windscreen wipers** can be used to have the exterior mirrors fold in when the vehicle is parked and locked >>>  page 33.

When the vehicle is locked with the remote control, the exterior mirrors are retracted automatically. When the vehicle is opened with the remote control, the exterior mirrors are deployed automatically.

WARNING

Convex or wide-angle* exterior mirrors give a larger field of vision. However, they make objects look smaller and further away than they really are. If you use these mirrors to estimate the distance to vehicles behind you when changing lane, you could misjudge the distance. Risk of accident!

CAUTION

- If one of the mirror housings is knocked out of position (e.g. when parking), the mirrors must first be fully retracted with the electric control. Do not readjust the mirror housing by hand, as this will interfere with the mirror adjuster function.
- Before washing the vehicle in an automatic car wash, please make sure to retract the exterior mirrors to prevent them from being damaged. Electrically retractable exterior mirrors must not be folded in or out by hand. Always use the electrical power control.

Note

If the electrical adjustment should fail to operate, both of the mirrors can be adjusted by hand by lightly pressing the edge of the mirror glass.

Seats and head restraints

Adjusting the seats and headrests

Manual adjustment of the seats

Read the additional information carefully >>>  page 19

WARNING

The safe driving chapter contains important information, tips, suggestions and warnings that you should read and observe for your own safety and the safety of your passengers >>> page 56.

WARNING

- Adjust the front seats only when the vehicle is stationary. Failure to follow this instruction could result in an accident.
- Be careful when adjusting the seat height. Careless or uncontrolled adjustment can cause injuries.
- The front seat backrests must not be reclined for driving. Otherwise, seat belts and the airbag system might not protect as they

¹⁾ Regulation in right-hand drive vehicles is symmetrical.

should, with the subsequent danger of injury.

Electric driver's seat adjustment*

Read the additional information carefully
 >>>  page 19

WARNING

- If the electric front seats are used negligently or without paying due attention, it can cause serious injury.
- The front seats can also be electrically adjusted when the ignition is switched off. Never leave a child or any other person who may need help in the vehicle.
- In the event of an emergency, electrical adjustment can be stopped by pressing any control.

CAUTION

To avoid damaging the electrical components of the front seats, please refrain from kneeling on the seat or applying sharp pressure at a single point to the seat cushion and backrest.

Note

- It may not be possible to electrically adjust the seat if the vehicle battery is very low.

- If the engine is started while the seats are being electrically adjusted, the adjustment will stop.

Adjusting the front head restraints

Read the additional information carefully
 >>>  page 19

Adjust the head restraint >>>  page 19 so that as far as possible the top of the head restraint is level with the top of your head. When this is not possible, try to get as close as possible to this position.

Adjustment of the rear head restraints

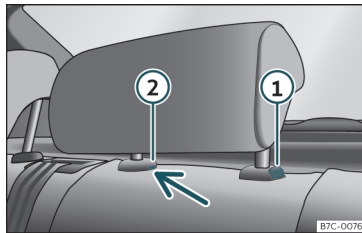



Fig. 126 Rear centre head restraint: release point.

When transporting people in the back seat, place the head restraints of the occupied



seats at a minimum of the next socket up >>> .

Adjusting the head restraints

- To set the head restraint higher, grasp the sides with both hands and move it upwards, until you see it engage.
- To set the head restraint lower down, press the  >>> **Fig. 126** button and move it downwards.

Removing the head restraint

To remove the head restraint, the corresponding backrest must be partially folded forward.

- Unlock the backrest >>> page 146.
- Move the head restraint upwards until it arrives to the top.
- Press button  >>> **Fig. 126**, while simultaneously pressing on the security hole  >>> **Fig. 126** with a flat screwdriver a maximum of 5 mm wide, and remove the head restraint.
- Move the backrest until it engages properly >>> .

Fitting the head restraint

To mount the external head restraints, the corresponding backrest must be partially folded forward.

- Unlock the backrest >>> page 146.
- Insert the head restraint bars into the guides until they perceptibly engage. It should not be possible to remove the head restraint from the backrest.
- Move the backrest until it engages properly >>> .

WARNING

- Please observe the general notes >>> page 61.
- Remove the rear head restraints only when it is necessary for the placement of a child seat >>> page 73. After removing a child seat, remount the head restraint immediately. Travelling with the head restraints removed or improperly adjusted increases the risk of severe injuries.

Seat functions

Introduction

WARNING

Inappropriate use of the seat functions can cause severe injuries.

- Assume the proper sitting position before your trip and remain in it throughout. This also applies to the other occupants.

- Always keep hands, fingers, feet and other parts of the body away from the operating radius and the adjustment of seats.

Seat heating





Fig. 127 On the centre console: front seats heating switch

The seat cushions can be heated electrically when the ignition is switched on. The backrest is also heated in some versions.



The seat heating should not be engaged in any of the following conditions:

- The seat is unoccupied.
- The seat has a covering.
- There is a child seat installed in the seat.
- The seat cushion is wet or damp.
- The indoor or outdoor temperature is greater than 25°C (77°F).



Activate

Press the button  or . Seat heating is switched on fully.

Adjusting the heating output

Press the button  or  repeatedly until the desired temperature is reached.

Deactivating

Press the button  or  until all the warning lamps switch off.

WARNING

Children and people who cannot perceive pain or temperature because of medications, paralysis or chronic diseases (e.g. diabetes) or have a limited perception of these, may suffer burns to the back, buttocks or legs when using seat heating, an occurrence that may entail a very lengthy recovery period or from which it may not be possible to recover fully. Seek medical advice if you have doubts regarding your health.

- People with limited pain and temperature thresholds must never use seat heating.
- If an abnormality in the device's temperature control is detected, have it checked by a specialist workshop. »

⚠ WARNING

If the fabric of the cushion is wet, this can adversely affect the operation of the seat heating, increasing the risk of burns.

- Make sure the seat cushion is dry prior to using the seat heater.
- Do not sit on the seat with clothing that is wet or damp.
- Do not leave clothing that is wet or damp on the seat.
- Do not spill liquid on the seat.

ⓘ CAUTION

- To avoid damaging the heating elements of the seat heaters, please do not kneel on the seat or apply sharp pressure to a single point on the seat cushion or backrest.
- Liquids, sharps objects and insulating materials (e.g. covers or child seats) can damage the seat heating.
- In the event of smells, switch off the seat heating immediately and have it inspected by a specialised workshop.

♻ For the sake of the environment

The seat heating should remain on only when needed. Otherwise, it is an unnecessary fuel waste.

Front centre armrest

The centre armrest can be adjusted to various levels.

Adjusting the centre armrest

- To adjust the tilt, lift the armrest from the starting position so that it is engaged.
- To return the armrest to the starting position, remove the armrest from the upper fixed position and lower it.

The armrest can be moved backwards and forwards.

Folding down and lifting the rear seat backrest

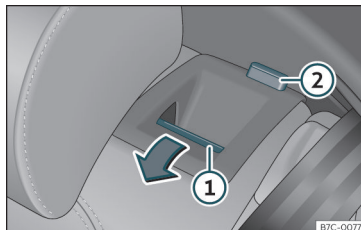

Fig. 128 On the rear seat backrest: release button ①; red mark ②.

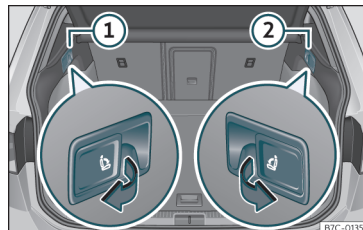

Fig. 129 In the trunk: levers for remote release of the left part ① and right part ② of the rear seat backrest.

The rear seat backrest is split and each part be lowered separately to extend the luggage compartment.

When the rear seat backrest is lowered nobody else can travel in the corresponding seats (not even a child).

Lowering the rear seat backrest with the unlock button

- Lower the head restraint properly.
- Push the unlock button »» Fig. 128 ① forwards and at the same time lift the backrest.
- The rear seat backrest is not engaged when the red marking of the button ② is visible.

Lowering the rear seat backrest with the remote release lever

- Lower the head restraint properly.
- Open the rear lid.
- Pull the remote release lever of the left part »» Fig. 129 ① or right part ② of the backrest in the direction of the arrow. The released part of the rear seat backrest is folded automatically down and forwards.
- If this occurs, close the rear lid.

The rear seat backrest is not engaged when the red marking of the button »» Fig. 128 ② is visible.

Folding up the rear seat backrest

- Lift the backrest and press it firmly into the lock until it engages »» ⚠.
- It should not be possible to see the red mark of the unlock button ②.
- The backrest must be properly engaged.

⚠ WARNING

Serious injuries can be caused if the rear seat backrest is lowered or lifted without due care and attention.

- Never lower or lift the rear seat backrest while driving.
- Do not trap or damage the seat belt when raising the rear seat backrest.

- When lowering or lifting the rear seat backrest, keep your hands, fingers, feet and other body parts out of its path.

- For the rear seat belts to offer the necessary protection all the parts of the rear backrest must be properly engaged. This is particularly important in the case of the centre rear seat. If someone is seated in a seat whose backrest is not properly engaged they will fly forward, along with the backrest, during an accident or a sudden driving or braking manoeuvre.

- A red signal on button ② warns that the backrest is not engaged. Always check that the red marking is not visible when the backrest is in the upright position.

- When the rear seat backrest is lowered or is not properly engaged nobody else can travel in the corresponding seats (not even a child).

⚠ CAUTION

Serious damage can be caused to the vehicle and other objects if the rear seat backrest is lowered or lifted without due care and attention.

- Before lowering the rear seat backrest, always adjust the front seats so that neither the head restraints nor the cushions of the rear backrest can hit them.

Transport and practical equipment

Storage compartments

Storage areas under the front seats*

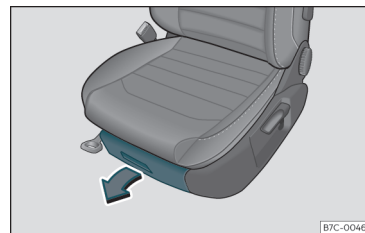

Fig. 130 Storage compartment under the front seats.

There is a storage compartment with a cover under each front seat.

The drawer* is opened by pulling on the handle of the cover »» Fig. 130.

To close the drawer, press the cover until it locks into position.

⚠ WARNING

- The drawers will hold a maximum weight of 1.5 kg.

»

- Do not drive with the drawer cover open. There is an injury risk for passengers if the cargo is released in case of sudden braking or an accident.

Drink holders



Fig. 131 Centre console: drinks holder.

Front drink holders

- Place drinks in the holder >>> Fig. 131. Placement of two drinks is possible. There is also the possibility of placing larger plastic bottles in the trims of the doors.

⚠ WARNING

- Do not place any hot drinks in the drink holder while the vehicle is moving. Hot drinks could spill and cause burns, which may cause an accident.

- Do not use hard china cups or glasses. These could cause injury in the event of an accident.

ⓘ CAUTION

You should avoid putting open drinks containers in the drink holders. The drinks could otherwise spill over and cause damage to e.g. the electrical equipment or the seat covers.

Glove compartment

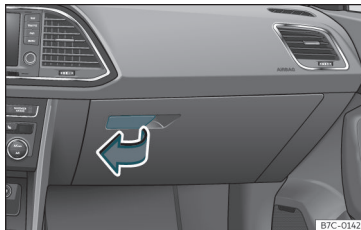

Fig. 132 Glove compartment

Opening/closing

- To open the glove compartment, pull the handle in the direction of the arrow.
- To close the glove compartment, move the cover upwards until it engages.

Depending on the vehicle equipment, the CD player is located in the glove compartment. Separate operating instructions are enclosed for this equipment in the corresponding Instruction Manual.

⚠ WARNING

The cover of the glove compartment should always be closed while driving. Failure to follow this instruction could result in an accident.

Other storage compartments

You will find more object holders, compartments and supports in other parts of the vehicle:

- In the top of the glove compartment in vehicles that do not have a CD reader. The load of the compartment should not exceed 1.2 kg.
- In the centre console under the centre armrest*.
- Coat hooks in the door frames >>> ⚠.
- Other storage compartments are found in the rear seat, to the left and the right of the seats.

WARNING

- Please make sure that any items of clothing hanging from the coat hooks do not obstruct your view to the rear.
- The coat hooks should only be used for lightweight clothing. Do not leave any heavy or sharp objects in the pockets.
- Do not use clothes hangers to hang up the clothing, as this could interfere with the function of the head-protection airbags.

Power sockets

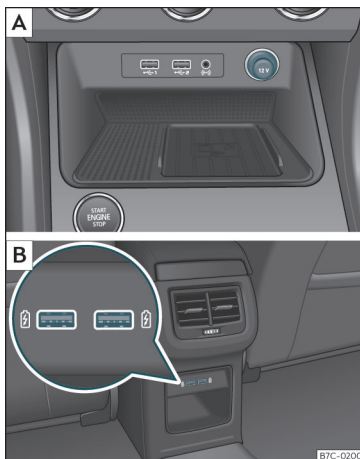

Fig. 133 **A** Centre console: front 12 volt power socket. **B** Rear of the centre console: USB sockets.



Fig. 134 Detailed view of the side trim in the boot: 12-volt power socket.

In the centre console

- Remove the cap located on the centre console of the socket >>> **Fig. 133. A**.
- Insert the plug of the electrical appliance into the power socket.

In the luggage compartment*

- Lift the power socket cover >>> **Fig. 134**.
- Insert the plug of the electrical appliance into the power socket.

Electrical equipment can be connected to the 12 volt power socket. The appliances connected to each power socket must not exceed a power rating of 120 Watt.

»

USB power sockets

Depending on the equipment and the country, the vehicle may also have USB connections **exclusively for charging or as a power socket**.

These USB ports are located at the rear of the console, between the front seats >> **Fig. 133** . These connectors can work at a maximum power of up to 10.5 W per port.

They are **not** intended for file playback.

WARNING

The power socket works only when the ignition is on. Improper use may cause serious injury or even fire. Children should therefore not be left in the vehicle unattended if the button is also left behind. Otherwise there is a possibility that they may be injured.

CAUTION

Always use the correct type of plugs to avoid damaging the sockets.

Note

- The use of electrical appliances with the engine switched off will cause a battery discharge.
- Should the connected appliance overheat, immediately switch it off and disconnect it from the socket.

- Before switching the ignition on or off, unplug the appliances from the USB ports to protect them from any damage caused by fluctuations in voltage.

Storing objects

Loading the luggage compartment

All luggage and other loose objects must be safely secured in the luggage compartment. Unsecured objects which shift back and forth could impair the driving safety or driving characteristics of the vehicle by shifting the centre of gravity.

- Distribute the load evenly in the luggage compartment.
- Place heavy objects as far forward as possible in the luggage compartment.
- Place the heavy objects first.
- Secure heavy objects to the fitted fastening rings >>> page 153.

WARNING

- Loose luggage and other objects in the luggage compartment could cause serious injuries.

- Always stow objects in the luggage compartment and secure them on the fastening rings.
- Use suitable straps to secure heavy objects.
- During sudden manoeuvres or accidents, loose objects can be thrown forward, injuring vehicle occupants or passers-by. This increased risk of injury will be further increased if a loose object is struck by an inflating airbag. If this happens, objects may shoot outward like a missile. Risk of fatal injury.
- Please note that the centre of gravity may shift when transporting heavy objects; this may affect vehicle handling and lead to an accident. Therefore, it is essential to adjust your speed and driving style accordingly, to avoid accidents.
- Never exceed the allowed axle weights or allowed maximum weight. If said weights are exceeded, the driving characteristics of the vehicle may change, leading to accidents, injuries and damage to the vehicle.
- Never leave your vehicle unattended, especially when the rear lid is open. Children could climb into the luggage compartment, closing the door behind them; they will be trapped and run the risk of death.
- Never allow children to play in or around the vehicle. Close and lock all the doors and the rear lid when you leave the vehicle. Before you lock the vehicle, make sure that

there are no adults or children in the vehicle.

Note

- Air circulation in the vehicle helps reduce fogging of the windows. Used air escapes through ventilation slits in the side trim of the luggage compartment. Ensure that the ventilation slots are never covered.
- Straps for securing the load to the fastening rings are commercially available from accessory shops.

Luggage compartment shelf

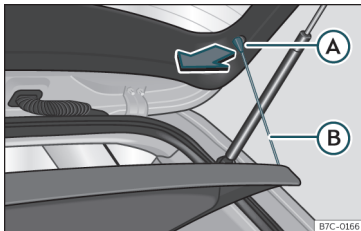

Fig. 135 In the boot: removing and installing the shelf.

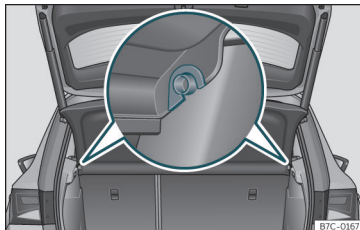

Fig. 136 In the boot: removing and installing the shelf.

The luggage compartment cover blocks the view into the luggage compartment.

Removing

- Detach the cord loops >>> **Fig. 135** **(B)** from their hooks **(A)**.
- Remove the rear shelf from the side supports >>> **Fig. 136** by pulling it upwards and then take it out.

If necessary, the rear shelf can be stored under the luggage compartment double floor >>> page 152.

Fitting

- Insert the cover horizontally so that the “recess” fits onto the axis of the supports >>> **Fig. 136** and press down until it engages.
- Hook the loops >>> **Fig. 135** **(B)** to the rear lid.

WARNING

- The luggage compartment cover must always be fixed properly (risk of accident).
- The luggage compartment cover should not be used as a storage shelf. Articles placed on this cover could cause injury to vehicle occupants in an accident or if the brakes are applied suddenly.

Storing the rear shelf

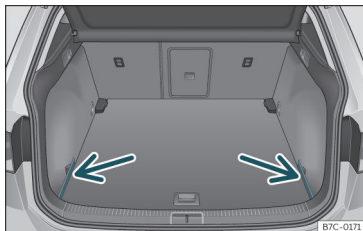

Fig. 137 In the boot: covers for storing the rear shelf.

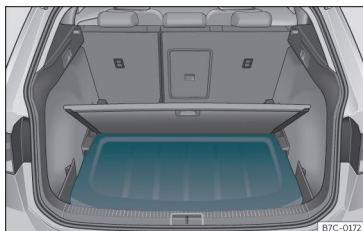

Fig. 138 In the boot: fitting the rear shelf.

The rear shelf can be stored under the luggage compartment variable floor.

- Remove the left and right covers
»» **Fig. 137**.
- Press the rear shelf until it engages in its housing
»» **Fig. 138**.

- Put the left and right covers in their original position.

Tailboard for transporting long items*

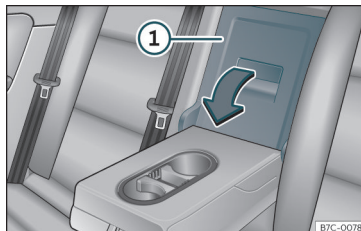

Fig. 139 On the rear seat backrest: opening the tailboard.

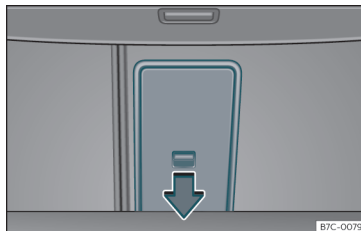

Fig. 140 In the boot: opening the tailboard.

On the rear seat, behind the central armrest, there is a tailboard for transporting long items in the interior, such as skis.

To avoid soiling the interior, dirty objects should be wrapped (e.g. in a blanket) before they are inserted through the tailboard.

When the armrest is down, nobody may travel in the centre rear seat.

Opening the tailboard

- Lower the centre armrest.
- Pull the release lever in the direction of the arrow and push the tailboard cover
»» **Fig. 139** ① down and forwards.
- Open the rear lid.
- Insert the long objects through the gap from the luggage compartment.
- Secure the objects with the seat belt.
- Close the rear lid.

Closing the tailboard

- Lift the tailboard cover until it engages. The red mark on the luggage compartment side should never be visible.
- Close the rear lid.
- Lift the centre armrest if necessary.

i Note

The tailboard can also be opened from the luggage compartment. To do so, press the release lever down, in the direction of the arrow, and the cover upwards
»» **Fig. 140**.

Fastening rings*

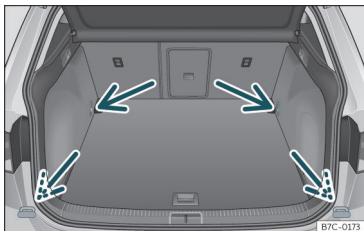

Fig. 141 In the boot: fastening rings.

In the front and rear part of the luggage compartment there are fastening rings to secure the luggage »» Fig. 141.

In order to use the fastening rings, they must be lifted beforehand.

⚠ WARNING

If unsuitable or damaged belts or retaining straps are used, they could break in the event of braking or an accident. Objects could then be launched across the passenger compartment and cause serious or fatal injuries.

- Always use belts or retaining straps that are suitable and in a good condition.
- Belts and retaining straps should be securely fastened to the fastening rings.

- Objects in the luggage compartment that are unsecured could move suddenly and modify the handling of the vehicle.
- Secure all objects, little and large.
- Never exceed the maximum tensile load of the fastening ring when securing objects.
- Never secure a child seat to the fastening rings.

i Note

- The maximum tensile load that the fastening rings can support is 3.5 kN.
- Belts and securing systems for the appropriate load can be obtained from specialised dealerships. To do so, CUPRA recommends going to a specialised CUPRA dealer or any SEAT dealership.
- The fastening rings are rendered unusable for versions with a spare wheel.

Retaining hooks

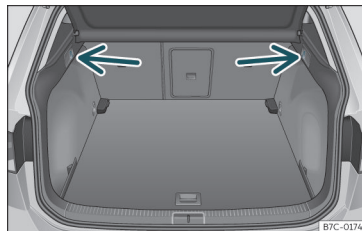

Fig. 142 In the boot: retaining hooks.

At the rear of the luggage compartment, on the left and right, there are fixed retaining hooks »» Fig. 142.

The retaining hooks have been designed to secure light shopping bags.

⚠ WARNING

Never use the retaining hooks as fastening rings. In case of sudden braking or an accident, the hooks could break.

ⓘ CAUTION

Each hook is designed for a maximum load of 2.5 kg.

Net bag*

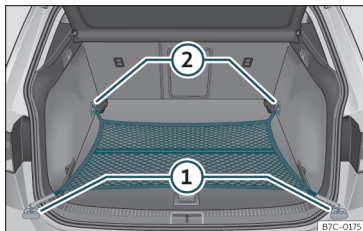

Fig. 143 In the boot: net bag hooked up at floor level.

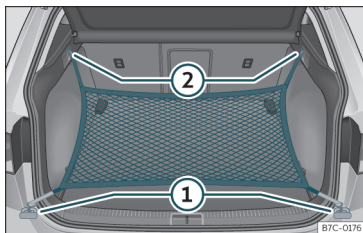

Fig. 144 In the boot: rings ① and hooks ② for attaching the net bag.

The luggage compartment prevents light luggage from moving. The net bag has a zip and can be used to store small objects.

The net bag can be hooked up to the luggage compartment in different ways.

Hooking the net bag into the luggage compartment floor

- As applicable, lift the front fastening rings >>> **Fig. 143** ②.
- Secure the net hooks to the fastening rings ② >>> ⚠. The bag zip should be facing upwards.
- Secure the net hooks to the fastening rings ①.

Hook the net bag next to the load threshold

- Secure the short net hooks to the fastening rings >>> **Fig. 144** ① >>> ⚠. The bag zip should be facing upwards.
- Secure the straps in the bag hooks ②.

Removing the net bag

The hooked up net bag is taut >>> ⚠.

- Remove the hooks and the net bag straps from the fastening rings and from the bag hooks.
- Store the net bag in the luggage compartment.

- Always secure the net hooks properly so that they do not suddenly release from the fastening rings when hooking or unhooking them.
- On hooking or unhooking them, protect your eyes and face in case the hooks are released suddenly.
- Always hook up the net bag hooks in the described order. If a hook is unexpectedly released the risk of injury is increased.

⚠ WARNING

To secure the elastic net bag on the fastening rings it must be stretched out. Once hooked up it is taut. If the net bag is hooked up or unhooked incorrectly the hooks could cause injuries.

Luggage compartment variable floor

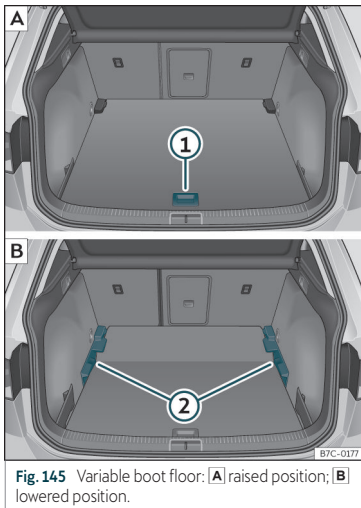

Fig. 145 Variable boot floor: **A**) raised position; **B**) lowered position.

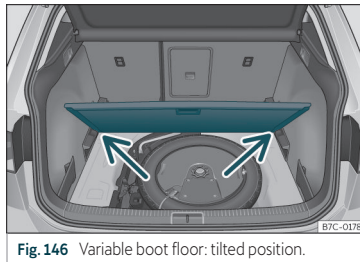

Fig. 146 Variable boot floor: tilted position.

Variable floor in high position

- To move from the low position to the high position, lift the floor using the handle >>> **Fig. 145** ①, and pull it back until the front of the floor has fully passed the supports ②.
- Move the floor forward over the supports as far as the rear seat backrest and then lower the floor with the handle ①.

Variable floor in low position

- To move from the high position to the low position, lift the floor using the handle >>> **Fig. 145** ①, and pull it back until the front of the floor has fully passed the supports ②.
- Now let the front part fall to the floor and slide the floor forwards as far as the rear seat backrest; lower the floor at the same time with the handle ①.

Variable floor in the tilted position

When the variable floor is tilted you can access the spare wheel/anti-puncture kit area.

- Lift the variable floor in the high position using handle >>> **Fig. 145** ①, pull it up and push it towards the backrest of the rear seats until the floor folds along the hinge line and the movable part of the floor is resting on itself.
- Rest the floor on its housings >>> **Fig. 146** (arrows).

Variable floor with folded seats

- To move from the high position to the low position, lift the floor using the handle >>> **Fig. 145** ① and pull it back a little.
- Push the variable floor towards the folded rear seats with the handle ① using some downward pressure so that the moving part of the floor is flush with the backs of the rear seats.

⚠ WARNING

During a sudden driving or braking manoeuvre, or in the event of an accident, objects could be flung through the interior and cause serious or fatal injuries.

- Always secure objects, even when the luggage compartment floor is properly lifted.

>>

- Only objects that do not protrude more than 2/3 the height of the floor may be carried between the rear seat and the raised luggage compartment floor.
- Only objects that do not weigh than approximately 7.5 kg may be carried between the rear seat and the raised luggage compartment floor.

CAUTION

- The maximum weight that can be loaded on the luggage compartment variable floor in the top position is 150 kg.
- Do not let the luggage compartment floor fall when closing it. Always carefully guide it downwards in a controlled manner. Otherwise, the lining and the floor of the luggage compartment could be damaged.

Note

CUPRA recommends the use of straps to secure objects to retaining rings.

Roof carrier*

Introduction

The vehicle roof has been designed to optimise aerodynamics. For this reason, cross bars or conventional roof carrier systems cannot be secured to the roof water drains.

As the roof water drains are integrated in the roof to reduce air resistance, only CUPRA-approved cross bars and roof carrier systems can be used.

Cases in which cross bars and the roof carrier system should be disassembled.

- When they are not used.
- When the vehicle is washed in a car wash.
- When the vehicle height exceeds the maximum height, for example, in some garages.

WARNING

When heavy or bulky loads are transported on the roof carrier system, car driving performance is affected, as the centre of gravity shifts and there is greater wind resistance.

- Always secure the load properly using belts or retaining straps that are suitable and in a good condition.
- Bulky, heavy, long or flat loads have a negative effect on aerodynamics, the centre of gravity and driving performance.
- Avoid sudden braking and manoeuvres.
- Adapt your speed and driving style at all times to suit visibility, weather, road and traffic conditions.

CAUTION

- Remove the cross bars and the roof carrier system before entering a car wash.
- Vehicle height is increased by the installation of cross bars or a roof carrier system and the load secured on them. For this purpose, check that your vehicle's height does not surpass the headspace limit, for example, for underpasses or for entering garage doors.
- Cross bars, the roof carrier system and the load secured on them should not interfere with the roof aerial or hamper the path of the panoramic sun roof and the rear lid.
- On opening the rear lid make sure that it does not knock into the roof load.

For the sake of the environment

When cross bars and a roof carrier system are installed, the increased air resistance means that the vehicle uses more fuel.

Attach the cross bars and the roof carrier system

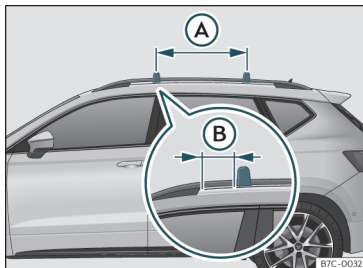

Fig. 147 Attachment points for the roof railings for the roof carrier system.

The crossbars are the basis of a series of special roof carrier systems. For safety reasons, special fixtures must be used to safely transport luggage, bicycles, skis, surf boards or boats on the roof. The appropriate accessories can be purchased at specialised CUPRA dealers or any SEAT dealership.

Always secure the crossbars and the roof carrier system properly. Always take the assembly instructions that come with the crossbars and the roof carrier system in question into account.

The crossbars are assembled on the roof railings. The distance between crossbars » **Fig. 147** **A** should be between 70 and 90

cm and the distance between the crossbars and the brackets of the roof railings **B** must be 15 cm.

⚠ WARNING

Incorrect attachment and use of the crossbars and the roof carrier system may cause the whole system to detach from the roof and cause an accident and injuries.

- Always take the manufacturer assembly instructions into account.
- Use only crossbars and the roof carrier system when they are in perfect condition and are properly secured.
- Secure the crossbars and the roof carrier system properly.
- Check threaded joints and attachments travelling and if necessary tighten them after you have travelled a short distance. When making long trips, check the threaded joints whenever you stop for a rest.
- Always fit the special roof carrier systems correctly for wheels, skis and surfboards, etc.
- Do not modify or repair the crossbars or roof carrier system.

i Note

Always read the assembly instructions that come with the crossbars and the roof carrier system carefully and keep them in the vehicle.

Loading the roof carrier system

The load can only be secured if the crossbars and the roof carrier system are properly installed » **⚠**.

Maximum authorised roof load

The maximum permissible roof load is **75 kg**. This figure comes from the combined weight of the roof carrier, the cross bars and the load itself on the roof » **⚠**.

Always check the weight of the roof carrier system, the cross bars and the weight of the load to be transported and weigh them if necessary. Never exceed the maximum authorised roof load.

If you are using cross bars and a roof carrier with a lower weight rating, you will not be able to carry the maximum authorised roof load. In this case, do not exceed the maximum weight limit for the roof carrier which is listed in the fitting instructions.

Distributing a load

Distribute loads uniformly and secure them correctly » **⚠**.

»

Check attachments

Once the cross bars and roof carrier system have been installed, check the bolted connections and attachments after a short journey and subsequently with a certain frequency.

WARNING

Exceeding the maximum authorised roof load can result in accidents and considerable vehicle damage.

- Never exceed the maximum authorised load on the roof and on the axles or the vehicle's maximum authorised weight.
- Never exceed the load capacity of the cross bars and the roof carrier system, even if the maximum authorised roof load has not been reached.
- Secure heavy items as far forward as possible and distribute the vehicle load uniformly.

WARNING

If the load is loose or not secured, it could fall from the roof carrier system or cause accidents and injuries.

- Always use belts or retaining straps that are suitable and in a good condition.
- Secure the load properly.

Air conditioning

Heating, ventilation and cooling

Introduction

Read the additional information carefully
 >>  page 39

Viewing Climatronic information

On the screen of Climatronic control unit and on the screen of the factory-fitted Easy Connect system, the theoretical values of the temperature zones are shown.

The unit of temperature measurement can be changed in the Easy Connect system.

Dust and pollen filter

The dust and pollen filter with its activated charcoal cartridge serves as a barrier against impurities in the air taken into the vehicle interior.

The dust and pollen filter must be changed regularly so that air conditioner performance is not adversely affected.

If the filter loses efficiency prematurely due to use in areas with very high levels of air pollution, the filter must be changed more frequently than stated in the Service Schedule.

WARNING

Reduced visibility through the windows increases the risk of serious accidents.

- Always ensure that all windows are free of ice and snow, and that they are not fogged, so as to maintain good visibility of everything outside.
- The maximum heat output required to defrost windows as quickly as possible is only available when the engine has reached its normal running temperature. Only drive when you have good visibility.
- Always ensure that you use the heating system, fresh air system, air conditioner and the heated rear window to maintain good visibility to the outside.
- Never leave the air recirculation on for a long period of time. If the cooling system is switched off and air recirculation mode switched on, the windows can mist over very quickly, considerably limiting visibility.
- Switch air recirculation mode off when it is not required.

WARNING

Stuffy or used air will increase fatigue and reduce driver concentration possibly resulting in a serious accident.

- Never leave the fresh air fan turned off or use the air recirculation for long periods of time; the air in the vehicle interior will not be refreshed.

ⓘ CAUTION

- To replace the pollen filter, always visit a service centre.
- Switch the air conditioner off if you think it may be broken. This will avoid additional damage. Have the air conditioner checked by a specialised workshop.
- Repairs to the air conditioner require specialist knowledge and special tools. CUPRA recommends going to a specialised CUPRA Service or SEAT Official Service.

ⓘ Note

- When the cooling system is turned off, air coming from the outside will not be dried. To prevent fogging of the windows, CUPRA recommends leaving the cooling system (compressor) turned on. To do this, press the **A/C** button. The button lamp should light up.
- The maximum heat output required to defrost windows as quickly as possible is only available when the engine has reached its normal running temperature.
- Keep the air intake slots in front of the windscreen free of snow, ice and leaves to ensure heating and cooling are not impaired, and to prevent the windows from misting over.

Operating the Climatronic through the Easy Connect system*

Fig. 148 Easy Connect screen: air conditioner menu.

In the Easy Connect system it is also possible to perform various adjustments to the Climatronic.

Open the air conditioner menu

- Press the **SETUP** button of the Climatronic control panel.

On the top of the screen you can see and change the current settings, such as, for example, the temperature set for the driver side and for that of passenger. Temperatures up to +22°C (+72°F) are shown with blue arrows, and temperatures over +22°C (+72°F) with red arrows.

To switch a function on or off, or to select a submenu, you must press the corresponding function button.

Function button: Function

OFF	Climatronic is switched off.
ON	Climatronic is switched on.
SYNC	Synchronise driver and front passenger temperatures.
	The air conditioning settings submenu is opened. The following settings can also be adjusted:
	Automatic supplementary heater: to activate/deactivate the automatic activation of the auxiliary heating for colder countries (only for engines with auxiliary heating). With the option deactivated, depending on the outside temperature the heating may need more time than normal to reach a comfortable temperature.
SETTINGS	Automatic front window heating:* to switch the automatic windscreen heating on and off »» page 162.
	Automatic air recirculation: to switch automatic air recirculation on and off »» page 161.
	BACK ↩: to close the submenu.
	It enables manual switching on or off of the windscreen heater.

»

Function button: Function



It enables activation and deactivation of the PureAir and opens the submenu.

Air conditioning user instructions

The interior cooling system only works when the engine is running and fan is switched on.

The air conditioner operates most effectively with the windows and the panoramic sliding sunroof closed. However, if the vehicle has heated up after standing in the sun for some time, the air inside can be cooled more quickly by opening the windows and the panoramic sliding sunroof briefly.

Climatronic: change the temperature unit on the screen of the factory-fitted infotainment system

The temperature display can be changed from Celsius to Fahrenheit on the screen of

the Infotainment system using the Infotainment button (MENU) > function button **Settings** > **Units**.

The cooling system cannot be activated

If the air conditioning system cannot be switched on, this may be caused by the following:

- The engine is not running.
- The fan is switched off.
- The air conditioner fuse has blown.
- The outside temperature is lower than approximately +3°C (+38°F).
- The air conditioner compressor has been temporarily switched off because the engine coolant temperature is too high.
- Another fault in the vehicle. Have the air conditioner checked by a specialised workshop.

Special characteristics

If the humidity and temperature outside the vehicle are high, **condensation** can drip off the evaporator in the cooling system and form a pool underneath the vehicle. This is normal and does not indicate a leak!

Note

After starting the engine, any residual humidity in the air conditioner could mist over the windscreen. Switch on the defrost function as soon as possible to clear the windscreen of condensation.

Air outlets

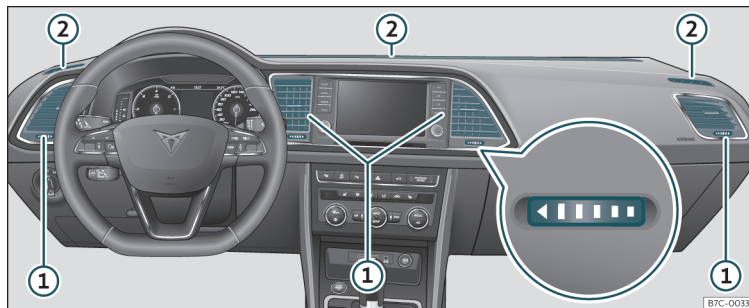

Fig. 149 On the dash panel air vents.

Air vents

To ensure proper heating, cooling and ventilation in the vehicle interior, air vents >>> Fig. 149 ① should remain open.

- Turn the corresponding thumbwheel (detail) in the required direction to open and close the air vents. When the thumbwheel is in the ► position, the corresponding air vent is closed.
- Change the air direction using the ventilation grille lever.

There are other additional, non-adjustable air vents in the dash panel ②, in the footwell and in the rear area of the interior.

Note

Food, medicine and other heat or cold sensitive objects should never be placed in front of the air outlets as they may be damaged or made unsuitable for use by the air coming from the air vents.

Air recirculation mode



Basic points

Air recirculation:

 Manual recirculation

Air recirculation mode prevents the ambient air from entering the interior.

When the outside temperature is very high, selecting manual air recirculation mode for a short period refreshes the vehicle interior more quickly.

For safety reasons, air recirculation mode is switched off when the button MAX  is pressed or the air distributor turned to .

Switching the manual air recirculation mode on and off 

Activate: press the  button until the warning lamp lights up.

Deactivate: press the  button until the warning lamp goes off.

>>

Functioning mode of automatic air recirculation (air conditioning menu)

With the automatic air recirculation mode activated, the entry of fresh air into the cabin interior is enabled. If the system detects a high concentration of hazardous substances in the ambient air, air recirculation mode is switched on automatically. When the level of impurities drops to within a normal range, recirculation mode is switched off.

The system is unable to detect unpleasant smells.

The air recirculation will **not** connect automatically in versions without humidity sensor and in the following external conditions:

- The outside temperature is lower than +3°C (+38°F).
- The cooling system is switched off and the outside temperature is below +10°C (+50°F).
- The cooling system is switched off, the outside temperature is below +15°C (+59°F) and the windscreen wipers are switched on.

Activation/deactivation of automatic air recirculation is done in the air conditioner menu, under Configuration.

WARNING

Observe the safety warnings >>>  in Introduction on page 158.

- If the cooling system is switched off and air recirculation mode switched on, the windows can mist over very quickly, considerably limiting visibility.
- Switch air recirculation mode off when it is not required.

CAUTION

Do not smoke when air recirculation is switched on in vehicles with an air conditioner. The smoke taken in could lie on the cooling system vaporiser and on the activated charcoal cartridge of the dust and pollen filter, leading to a permanently unpleasant smell.

Note

Climatronic: air recirculation mode is activated to prevent exhaust gas or unpleasant odours from entering the vehicle interior when it is in reverse and while the automatic windscreen wiper is working.

Heated windscreen*

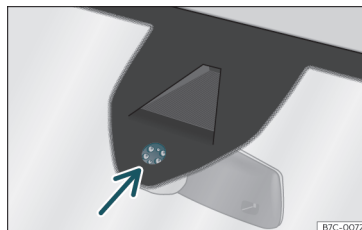



Fig. 150 Windscreen humidity and temperature sensor.

The heated windscreen is comprised of a set of heated wires placed between the layers of the windscreen which, when electric current is supplied to them, heat up and cause the temperature of the glass to rise.

Its function is to assist the air-conditioning system to prevent the windscreen from misting up or to demist it faster if it does mist up.

The system can be switched on manually or automatically.

Manual activation

- Press the **SETUP** button of the Climatronic control panel.
- Press the  function button to switch the windscreen heating on or off.

Automatic activation

To facilitate use of the heated windscreen it can turn on automatically.

The Climatronic control panel can detect the danger of the windscreen misting thanks to its temperature and humidity sensors, switching the system on or off accordingly »» **Fig. 150**. Moreover, it will also be activated automatically when the  **MAX** button is pressed on the Climatronic control panel.

Adjust it as follows for it to switch on automatically:

- Press the **SETUP** button of the Climatronic control panel.
- Press the **SETTINGS** function button on the infotainment system.
- Switch the function on or off by pressing the Automatic windscreen heating function button.

Infotainment System

Introduction

Safety instructions related to the Infotainment system

Travelling on today's roads requires the driver's full attention at all times.

Only operate the infotainment system and its various functions when the traffic situation really permits this.

WARNING

- Before starting the trip, you should familiarise yourself with the different infotainment system functions.
- High audio volume may represent a danger to you and to others.
- Adjust the volume in a way that you can distinguish surrounding noise, for example, horns and sirens, etc.
- Changes to the Infotainment system settings should be made when the car is stopped, or by a passenger.

WARNING

Distracting the driver in any way can lead to an accident and cause injuries. Operating

the Infotainment system can distract your attention from the traffic.

- Always drive carefully and responsibly.
- Select volume settings that allow you to easily hear signals from outside the vehicle at all times (e.g. emergency services sirens and horns).
- Hearing may be impaired if using too high a volume setting, even if only for short periods of time.

WARNING

The volume level may suddenly change when you switch audio source or connect a new audio source.

- Lower the base volume before connecting or switching audio sources.

WARNING

The driving recommendations and traffic indications shown on the navigation system may differ from the current traffic situation.

- Traffic signs and traffic regulations have priority over the recommendations and displays provided by the navigation system.
- Adjust your vehicle speed and driving style to suit visibility, weather, road and traffic conditions.

WARNING

Connecting, inserting or removing a data medium while driving can distract your attention from the traffic and cause an accident.

WARNING

Connecting leads for external devices may obstruct the driver.

- Arrange the connecting leads so that they do not obstruct the driver.

WARNING

External devices that are loose or not properly secured could move around the passenger compartment during a sudden driving or braking manoeuvre or an accident and cause damage or injury.

- Never place or fit external devices to the doors, windscreen, steering wheel, dash panel, the backs of the seats, on top of or near the area marked "AIRBAG" or between these areas and the occupants. External devices can cause serious injury in an accident, especially when the airbags inflate.

WARNING

The armrest may obstruct the driver's arm movements, which could cause an accident and severe injuries.

- Always keep the armrest closed while the vehicle is in motion.

WARNING

Opening a CD or DVD player's housing can lead to injuries from invisible laser radiation.

- Have CD or DVD players repaired only by a qualified workshop.

CAUTION

The Infotainment system can be damaged by the incorrect insertion of a data storage device or the insertion of an incompatible data storage device.

- When inserting a data storage device, make sure it is correctly positioned.
- Applying force may irreparably damage the memory card slot locking mechanism.
- Only use compatible memory cards.
- When inserting and removing CDs and DVDs, always hold them at right angles to the front of the CD/DVD drive without tilting so as not to scratch them.
- If a CD or DVD is inserted while another is already in the unit or being ejected, the DVD drive may be irreparably damaged. Always wait until the data medium is completely ejected.

CAUTION

Any foreign objects stuck to a data storage device and non-round media may damage the CD or DVD player.

- Only clean, standard 12 cm CDs or DVDs should be used.
 - Do not affix stickers or other items to the data medium. Stickers may peel off and damage the drive.
 - Do not use printable data media. Printed labels and coverings may peel off and damage the CD/DVD drive.
 - Do not insert 8 cm single CDs or irregularly shaped CDs or DVDs.
 - Do not insert DVD-Plus discs, Dual Discs or Flip Discs, as these are thicker than normal CDs.

CAUTION

The vehicle loudspeakers may be damaged if the volume is too high or the sound is distorted.

Note

For the proper functioning of the Infotainment system it is important that the date and time set in the vehicle are correct.

Overview of the unit

Navi System Plus

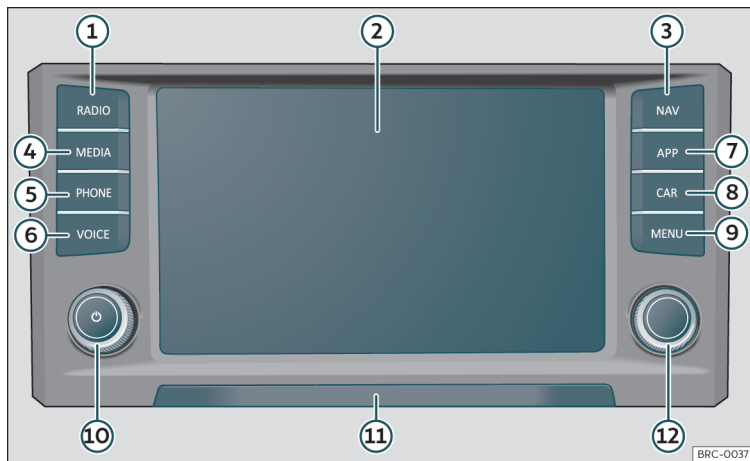

BRC-0037

Fig. 151 Overview of the controls

- | | | |
|--|---|---|
| ① Radio Mode (change of band frequency)
»» page 182 | ⑥ Voice control | ⑫ Settings button (search and selection)
»» page 167 |
| ② Touchscreen »» page 168 | ⑦ Full Link »» page 172 | |
| ③ Navigation Mode »» page 193 | ⑧ Vehicle settings »»  page 33,
»» page 205 | |
| ④ Media mode (audio sources)
»» page 184 | ⑨ Selecting the main menu »» page 167 | |
| ⑤ Phone Mode »» page 206 | ⑩ Volume. Off/on »» page 167 | |
| | ⑪ Proximity sensor »» page 170 | |

General instructions for use

Introduction

If the setup is changed, this may change the display on the screen and in some cases, the Infotainment system may behave in a manner different to that described in this manual.

Note

- Lightly pressing the buttons or briefly pressing the touchscreen is sufficient to operate the Infotainment system.
- Not all listed function buttons and functions described may be available due to the device software used in your market. The equipment is not faulty if a function button is missing from the screen.
- Due to country-specific legislation, certain functions may not be available on the screen when the vehicle is travelling above a certain speed.
- Using a mobile telephone in the vehicle may cause noise from the vehicle loudspeakers.
- Restrictions on the use of devices using Bluetooth® technology may apply in some countries. For further information, contact the local authorities.
- On some vehicles with ParkPilot, the volume of the audio source is automatically lowered when reverse gear is selected. You

can change settings for lowering the volume in the **Sound setup > VoLume** menu.

Diagram of the menus

The Infotainment system touchscreen can be used to select the different main menus.

Press the Infotainment button  to open the menus summary .

The display of the touchscreen's main menu can be switched between "grid" and "carousel" via the **Settings > Display** menu .

Infotainment rotary/push knobs

Rotary/push knobs

The left-hand rotary knob  is the volume control or the on/off button.

The right-hand rotary knob is the setup button.

Infotainment buttons

The buttons on the unit are shown in this manual with the word "infotainment button" and their function within a rectangle, for example, the infotainment button .

The Infotainment buttons are used by *pressing them or pressing and holding*.

Switching on and off

To manually switch the Infotainment system on and off, briefly *press* the left rotary knob .

When switching on, the system starts-up with the last set volume, provided that this does not exceed the preset maximum start-up volume. Select **Sound > VoLume**.

The unit will switch off automatically when the key is removed from the ignition or when the on/off button is pressed (depending on the equipment fitted or the vehicle). If the Infotainment system is switched on again, it will switch off automatically after approximately 30 minutes (switch-off delay).

Note

- The Infotainment system is a part of the vehicle. It cannot be used in any other vehicle.
- If the battery has been disconnected, the ignition must be activated before switching on the Infotainment system.

Changing the basic volume

Increasing or decreasing the volume or muting the sound

Raise the volume: turn the volume control ⏻ clockwise or move the left thumbwheel on the multifunction steering wheel upward ▲.

Lower the volume: turn the volume control ⏻ clockwise or move the left thumbwheel on the multifunction steering wheel downward ▼.

Changes in volume are indicated by a volume bar on the screen. The volume can be controlled using the steering wheel controls. In this case, the changes in volume are displayed on the instrument panel by a volume bar.

It is possible to preset certain volume settings and adjustments. Select **Sound** > **Vo1-ume**

Muting the Infotainment system sound

- Turn the volume control ⏻ anti-clockwise until it displays 🔇.

Muting the Infotainment system sound stops the media source that is playing. The screen displays 🔇.

i Note

If the base volume has been considerably increased to play a certain audio source,

lower the volume again before switching to another audio source.

Handling the function buttons and display instructions

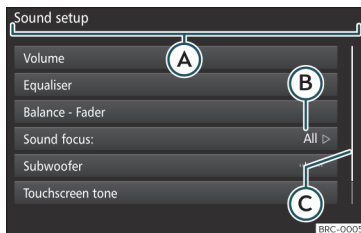

Fig. 152 View of some of the function buttons on the screen.

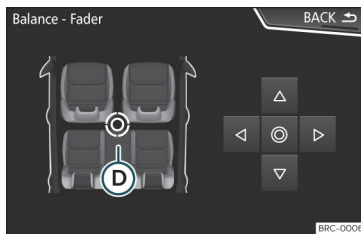

Fig. 153 Sound setup menu

The Infotainment system comes equipped with a touchscreen.

Active areas of the screen that call up a certain function are called “function buttons”. These buttons are operated by *briefly pressing* the screen or by *pressing and holding*.

The function buttons appear in the instructions with the label “function button” and a button symbol inside a rectangle.

Function buttons start functions or open submenus. The currently selected menu is displayed in the title bar >>> **Fig. 152** **A** of the submenus.

Inactive (grey) function buttons cannot be selected.

Increase or decrease the size of the images displayed on the screen

The size of the navigation map image >>> page 193 and, for example, photos when viewing images >>> page 184 can be enlarged or reduced. To do so, enlarge or reduce the image displayed by moving two fingers.

Overview of screen and function buttons

Display and function buttons: operation and effect

- A** The title bar shows the selected menu and, where applicable, other function buttons.

Display and function buttons: operation and effect

B Press it to open another menu.

The scroll bar is shown on the right and its size depends on the entries in the list. Move the bar on the screen by pressing lightly and without lifting the finger, see >>> page 169, Opening list entries and searching in lists.

C

Movable cursor: Move the cursor around the screen by pressing lightly and without lifting the finger.

OR: To move the cursor to a particular position, press that spot on the screen.

D

Fixed crosshair: Press the up, down, left and right arrows to move the sound according to preference. The cursor **D** will move.

OR: Press the central button to centre the stereo sound in the centre of the passenger compartment

□

Press it on some lists to move up a level, one by one.

BACK ←

Press to return from the submenus one at a time to the main menu or to undo the entries made.

▽

When pressed, a pop-up window opens (options window) which displays other set-up options.

Display and function buttons: operation and effect

Some functions or messages are accompanied by a check box and are activated or deactivated by pressing said check box.

OK Press to confirm an entry or a selection.

x Press to close a pop-up window or an input window.

+ / - Press them to change the setup adjustments one at a time.

□ Move the slider around the screen by pressing it lightly and without lifting your finger.

Opening list entries and searching in lists

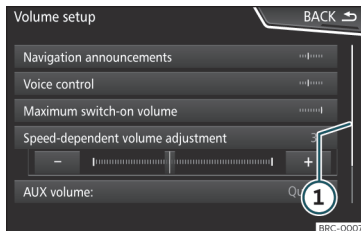

Fig. 154 Entries on a setup menu list.

The entries on a list can be activated by pressing them on the screen directly or by using the adjustment button.

Mark list entries using the setup button and open them

- Turn the setup button to mark the entries on the list with a rectangle one by one and continue searching the list in this manner.
- Press the setup button to activate the marked entry on the list.

Search lists (scrolling the screen)

The scroll bar is shown on the right and its size depends on the entries in the list >>> **Fig. 154** **1**.

- Briefly press the screen above or below the scroll marker.
- **OR:** Place a finger over the scroll marker and *without lifting it*, move it around the screen. Lift your finger off the screen when you reach the desired position.
- **OR:** Place your finger in the centre of the screen and *without lifting it*, move it around the screen. Lift your finger off the screen when you reach the desired position.

Input masks with on-screen keypad

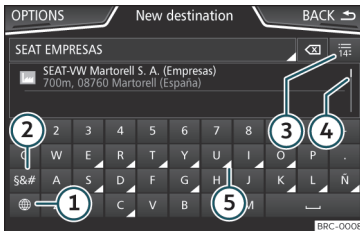

Fig. 155 Input window with on-screen keypad.

Input windows with on-screen keypad are used for functions such as entering an entry name, selecting a destination address or entering a search term for searching long lists.

The function buttons listed below are not available in all countries or for all topics.

Subsequent chapters only explain those functions that differ from those in the screen shown in the figure.

The input line with cursor is located in the top bar of the screen. All inputs are displayed here.

Input windows for “free text input”

In the input masks for open text, you may enter letters, numbers and special characters in any combination.

Input windows for selecting a saved entry (e.g. selection of a destination address)

It is only possible to select a sequence of letters, numbers and special characters that matches a stored entry.

Suggestions for matching destinations appear depending on the characters entered in the input line » Fig. 155 ④. In the case of compound names, it is necessary to enter a space.

If there are fewer than 99 selectable entries, the number of remaining entries is displayed after the input line ③. Pressing this function button displays these remaining entries in a list.

Overview of the function buttons

Function icon and text: operation and effect

Letters and digits	Press them to copy them into the input line.
①	Press to change the keypad to another language. Keypad languages can be selected from the menu System settings > Language .
②	Press to show symbols on the keypad.
③	Displays the number and opens the list of remaining selectable entries that match the entered text.

Function icon and text: operation and effect

④	Scroll bar, the size of which depends on the number of matching entries.
⑤	Hold and press to display a pop-up window with the special characters based on said letter. Press the desired character to enter it. Some special characters can be written out instead (e.g. “AE” for “Ä”).
␣	Press to enter a space.
⌫	Press to delete characters in the input line from right to left. Press and hold to delete several characters.
BACK ↩	Press to close the input window.

Proximity sensors

The Infotainment system is equipped with an integrated proximity sensor » Fig. 151 ⑩.

The image on the screen changes from display mode to automatic operation when your hand moves toward it. In operation mode, the function buttons are automatically highlighted to facilitate their use.

Additional information and display options

The displays appearing on the screen may vary depending on the settings, and may differ from those described here.

The status bar on the screen can display, for example, the current time and outside temperature.

All displays can be viewed only after completely restarting the Infotainment system.

Initial configuration wizard

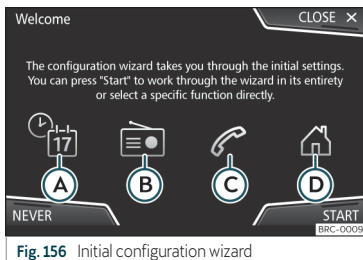

Fig. 156 Initial configuration wizard

The initial configuration wizard will help you to set up your Infotainment system the first time you switch it on.

Every time you switch on the Infotainment system, the initial setup screen will appear

>>> Fig. 156 if any parameters have not been set or if the **NEVER** function button has not been pressed.

Function button: function

CLOSE	Closes the Configuration Wizard, and the main menu or last mode in which you used the Infotainment system will appear. The next time you switch on the system, the Configuration Wizard will start up again.
NEVER	Disables the possibility of changing the settings of the Infotainment system. If you want to perform the initial system setup, you must enter via System setup and select Configuration Wizard .
START	Starts up the Configuration Wizard.
A	Press to configure the time and date (if it has a navigation system it will be configured automatically with the GPS).
B	Press to search and store to memory the radio stations that have the best reception at that moment on all available bands (AM, FM and DAB).
C	Press to link your mobile telephone to the Infotainment system.
D	Press to select your home address using your current position or by manually entering an address.

Function button: function

PREVIOUS	To go to the previous or next parameter to set.
NEXT	When a parameter has been set, the only way to reset it is from the main menu, clicking on it, and not using the Previous/Next buttons. When setting any parameter, a confirmation mark will appear on it <input checked="" type="checkbox"/> .
FINISH	Once one or more settings have been applied, click on this in the main menu of the wizard to confirm and finalize the settings. If there are any parameters you have not set, the next time you connect the Infotainment system, the Initial Configuration Wizard will start up.

Connectivity

Data transfer

This communication can allow data to be read and/or written.

From the SETTINGS menu > *Data transfer for SEAT apps*, there is a checkbox to activate/deactivate the function and a drop-down menu called *Operation via apps* which controls the level of interaction between the apps and the system.

Full Link*

Full Link technology description

The Full Link system provides a way of bringing together technologies that allow communication between the Infotainment System and mobile devices:

- MirrorLink®
- Android Auto™
- Apple CarPlay™

Interfaces

To access the Full Link system, press the Infotainment button  (Full Link) or press the

infotainment button  and then select the **Full Link** context.

The connection to Full Link is made through a USB interface.

WARNING

If a mobile terminal is not secured or is incorrectly secured in the vehicle, it could move around the passenger compartment in the event of a sudden driving manoeuvre, emergency stop or accident, resulting in injury.

- While driving, mobile terminals must be securely fastened in position, outside the airbag deployment zones, or safely stowed away.

WARNING

Any applications that are not suitable or execute incorrectly may cause damage to the vehicle, accidents and serious injuries.

- CUPRA recommends the use of the Apps that SEAT provides for this vehicle.
- To make full use of SEAT Apps, you must activate the option Setup, Data transfer for SEAT apps.
- The interaction level of the Apps on the system must be: ALLOW.
- Protect the mobile terminal with its applications from improper use.
- Never make modifications to the applications.

- Consult the instruction manual for the mobile terminal.

WARNING

The use of applications while driving can distract your attention from the traffic. Distracting the driver in any way can lead to an accident and cause injuries.

- Always drive carefully and responsibly.

CAUTION

In areas where special regulations apply or the use of mobile terminals is forbidden, the mobile terminal must be switched off at all times. The radiation produced by the mobile terminal when switched on may interfere with sensitive technical and medical equipment, possibly resulting in malfunction or damage to the equipment.

- CUPRA cannot be held liable for any damage caused to the vehicle as a result of the use of applications that are of poor quality or are defective, the inadequate programming of the applications, the insufficient coverage of the network, the loss of data during transmission or the improper use of mobile terminals.

Note

- Use of Full Link technology may result in high consumption of your 3G/4G data plan.

- CUPRA recommends having a high battery charge on the device when connected to Full Link.
- CUPRA recommends that to use Full Link, the “Date and time” should be correctly configured. Select Settings > Date and Time.
- SEAT applications are designed to communicate with the vehicle and interact with it via the Full Link connection, therefore its functionality is linked to the mobile device being connected via USB.
- Information about the technical requirements, compatible devices, adapted applications and availability can be obtained at www.cupraofficial.com, at specialised CUPRA dealers or any SEAT dealership.

Is Full Link blocked?

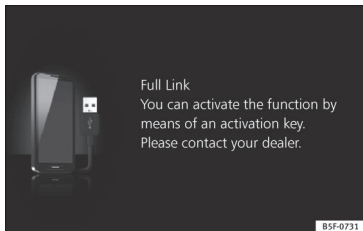

Fig. 157 Message on Infotainment system screen.

You will have to go to a specialised CUPRA dealer or any SEAT dealership to unlock this function. Otherwise, a message like this will appear on the screen whenever you select the feature >>> **Fig. 157.**

Requirements for Full Link

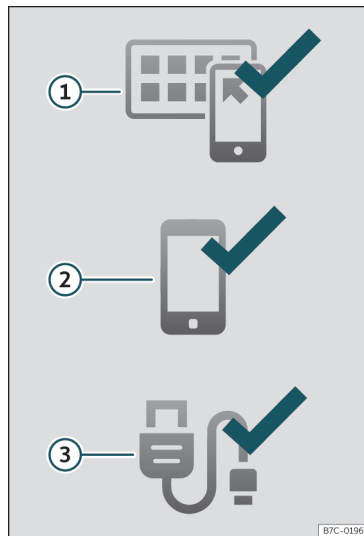

Fig. 158 Full Link Requirements

- ① **Full Link Activated:** If you do not have Full Link in your vehicle you can acquire it as an accessory at your Authorised Service.
- ② **Compatible Phones.** Go to the MirrorLink®, Android Auto™ or Apple CarPlay™ websites to confirm whether your phone is compatible with the system.

Mirror Link

- Check smartphone compatibility: www.mirrorlink.com/phones
- MirrorLink® 1.1 or higher
- Some of the Apps certified by SEAT or the CCC must be installed in the device.

Android Auto

- Check smartphone compatibility. Android Auto™: www.android.com/auto/
- Android 5.0 (Lollipop) or higher
- Install Android Auto™ app

Apple CarPlay

- Check smartphone compatibility. Apple CarPlay™: www.apple.com/ios/carplay
- iPhone 5 or higher and iOS 7.1 or higher
- Turn on the SIRI personal assistant (see phone settings)



- 3 **USB cable connecting car to phone:** use the USB cable approved and supplied by the phone's official distributor.

Activation of Full Link

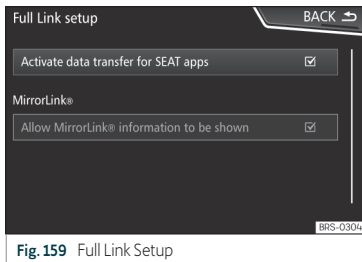

Fig. 159 Full Link Setup



Fig. 160 Full Link menu

Data connection via Wi-Fi or SIM is not necessary to establish the connection between the smartphone and Full Link.

Data connection via Wi-Fi or SIM is necessary to enable all of the app features¹⁾.

Proceed as follows to use Full Link:

- Switch on the Infotainment system
- Connect the smartphone to the vehicle's USB port using a USB cable »» page 212.
- In the main menu for the Full Link setup, select **Activate data transfer for SEAT apps** »» Fig. 159:

Finally, a message will appear stating that data transfer will commence when the device is connected. Please note that data is transferred over connections between your vehicle and mobile device. Press **OK**. Once selected, the technology compatible with your device can be used.

Note

Depending on your smartphone, it may have to be unlocked for the connection to occur.

¹⁾ Using the data connection to transfer the smartphone apps to Full Link may involve additional charges. Please check the charges with your operator.

What should I do if it does not connect?

Restart the mobile device

Check the USB cable visually.

Make sure that the USB cable is not damaged. Check that both connections (USB/micro USB) are not damaged or worn.

Visually check that the USB ports are properly connected.

Check that the vehicle and device USB connections are not damaged and/or worn.

Clean the USB ports (device and vehicle).

Try another compatible mobile device.

Have the USB port replaced at an authorised dealership.

Have the mobile device repaired or replace it.

Try another compatible mobile device.

Pairing of portable devices supporting the MirrorLink®, Android Auto™ and/or Apple CarPlay™ technologies

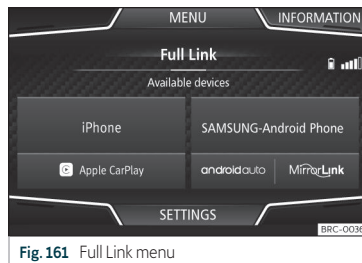

Fig. 161 Full Link menu

Carousel

When you enter the Full Link context for the first time, the technologies available for pairing the portable device are displayed.

Once the device connects via USB, the system will offer you the technologies available for establishing a connection with your mobile phone.

In the event of simultaneous connections between two devices with different operating systems, a choice will be presented for

which one to make the connection with >>> Fig. 161.

View of the device list

iPhone™ devices only support Apple CarPlay™.

There are some Android devices that support MirrorLink® and Android Auto™.

Bear in mind that once the device is connected it will not be available as an audio source.

Full Link setup

Function button: function

Activating data transfers for SEAT applications allows the exchange of information between the vehicle and applications authorised by SEAT.

Last Mode

If a session using one technology ends without the disconnection being made from the Infotainment system (simply by disconnecting the cable) then when the device is next connected to it, the session will start without the user being required to take any action¹⁾.

Information

Consult the mobile device manual. »

¹⁾ Unless the device requires the screen to be unlocked in order to establish the connection.

Depends on each technology:

1. Availability in a country
2. Third party applications

For further information:

MirrorLink®:
www.mirrorlink.com

Apple CarPlay™:
www.apple.com/ios/carplay

Android Auto™:
www.android.com/auto

Note

- In order to use Android Auto™ technology it is necessary to download the Android Auto™ application, located on Google Play™.
- Only compatible applications can be used, in accordance with the technology connected.

MirrorLink®



Fig. 162 Function buttons in the general view of compatible applications.



Fig. 163 Other MirrorLink function buttons.

MirrorLink® is a protocol which enables communication between a portable device and the Infotainment system via USB.

Using it makes it possible to display and manage the content and functions displayed on

the portable device on the Infotainment system screen.

To avoid distracting the driver while driving, only specially adapted applications can be used >>> [△](#) in Full Link technology description on page 172.

Requirements

In order to use MirrorLink®, the following requirements must be met:

- The mobile device must be compatible with MirrorLink®.
- The mobile device must be connected to the Infotainment system via USB.
- Depending on the mobile device used, a suitable application must be installed for the use of MirrorLink® on the device.

Initiating the connection

- In order to initiate the connection with the mobile device, it is simply necessary to connect it to the Infotainment system via the USB connection.
- A pop-up screen will appear, which will request that you accept the device.

Function buttons and possible messages

Function button: function

Full Link	To return to the Full Link main menu.
------------------	---------------------------------------

Function button: function

CLOSE APPS	Press to close the open apps. Then press the apps to be closed or the Close all function button to close all the open applications.
1 : 1	Press to change to the mobile device screen.
SETTINGS	To open the Full Link setup
»» Fig. 163 ①	Press to return to the MirrorLink® main menu.
»» Fig. 163 ②	Press to display all the function buttons in the lower or upper right-hand margin of the screen.
»» Fig. 163 Δ / ▷	Allows buttons ① and ② to be hidden or shown.
»» Fig. 151 ⑫	

MirrorLink® setup

Function button: function

Activate MirrorLink pop-up windows: Allows MirrorLink® pop-up windows in applications that support it.

Apple CarPlay™*

✓ Valid for compatible iPhone™ mobile telephones. Also, iPhone™ mobile telephones only support Apple CarPlay™

Apple CarPlay™ is a protocol which enables communication between a mobile telephone and the Infotainment system via USB.

This makes it possible to display and operate the mobile telephone on the Infotainment system screen.

Requirements

In order to use Apple CarPlay™, the following requirements must be met:

- Make sure that you do not have Apple CarPlay™ restricted on your device, at: **Settings > General > Restrictions > CarPlay > ON**.
- The mobile device must be compatible with Apple CarPlay™.
- The mobile device must be connected to the Infotainment system via USB.

Initiating the connection

In order to initiate the connection with the mobile device, it is simply necessary to connect it to the Infotainment system via the USB connection.

- A pop-up screen will appear, which will request that you accept the device.

• If you start the session using Apple CarPlay™ technology, it will not be possible to pair another device via Bluetooth®. The following message will appear in the main *Phone* menu:

Please disconnect Apple CarPlay first, before you can connect another mobile telephone.

Holding down the steering wheel multifunction  button or the **VOICE** button of the Infotainment system will start the Apple™ “voice engine”.

To return to the basic contents of the Infotainment system, press the **SEAT** icon.

Android Auto™*

✓ Valid for compatible Android mobile phones.

Android Auto™ is a protocol which enables communication between a portable device and the Infotainment system via USB.

This makes it possible to display and operate the mobile telephone on the Infotainment system screen.

Requirements

In order to use Android Auto™, the following requirements must be met: »

- The mobile device must be compatible with Android Auto™.
- The mobile device must be connected to the Infotainment system via USB.
- The Android Auto™ application should already be downloaded and installed on the mobile device.

Initiating the connection

In order to initiate the connection with the mobile device, it is simply necessary to connect it to the Infotainment system via the USB connection, and to be sure to follow the instructions of the device being paired.

- The first connection to Android Auto™ must be done while the vehicle is stationary.
- Once the first pop-up window about accepting data transfer between the car and the device has been accepted, a message will appear requesting that you check your mobile device for the confirmations needed to pair it with the Infotainment system.
- If you are initiating the session using Android Auto™ technology via USB, the mobile telephone connects automatically via Bluetooth® to the Infotainment system telephone and it will not be possible to pair another mobile telephone via Bluetooth®.

Holding down the steering wheel multifunction  button or the **VOICE** button of the Info-

tainment system will start the Android™ “voice engine”.

To return to the basic contents of the Infotainment system, press the **Return to SEAT** button.

Note

Some mobile devices require a change in the USB connection mode in order to use Android Auto™.

- Make sure that your mobile is in “Media Transfer Protocol (MTP)” mode before it is connected by USB to the Infotainment system.

Note

Android Auto™ requires the use of Google™ services, as well as certain basic applications of the Android system.

- Make sure that you always have Google™ services updated in order to use this technology.

Frequently asked questions about Full Link

What is the connection method?

USB Cable.

Will the USB cable be supplied with the vehicle?

No. The USB cable supplied with the device should be used.

Is there a navigation option?

Navigation is possible in each one of the Full Link technologies if the technology is available in your country and if you have the Navigation app.

What is the difference between using the Full Link system navigator (via telephone) instead of another navigator?

Benefits: Daily updates.
Issues: data consumption, reception problems.

Can I send voice messages?

With certified apps, you can answer but not send voice messages.

What apps are visible while driving?

Depending on the technology:
– for MirrorLink®: SEAT-certified apps and CCC,
– for Android Auto™: Apps selected by Google™,
– for Apple CarPlay™: Apps selected by Apple™.

Where can I find compatible apps?

Compatible apps can be found on the following links:
www.mirrorlink.com/
www.android.com/auto/
www.apple.com/ios/carplay/

Where can I download apps?

On Google Play™ for Android Auto™/MirrorLink® and on Apple Store™ for Apple CarPlay™.

If Full Link stops working, where can I have it repaired?

If the problem is in the car, you should go to the dealer. If the problem is in the mobile device, you should see your mobile telephone vendor.

Will WhatsApp be certified?

This depends on the technology.

Is MirrorLink® available in my country?

Yes, MirrorLink® is available in all the countries and regions where CUPRA operates.

What are the differences between MirrorLink®, Android Auto™ and Apple CarPlay™?

MirrorLink® is not compatible with Android Auto™ and Apple CarPlay™, as they are different technologies. They all coexist in Full Link, although Android Auto™ is designed for mobile devices with the Android™ operating system, and Apple CarPlay™ for iPhone.

Can MirrorLink® be installed in a previous CUPRA model?

No, this is not possible.

Where can I find more information about Full Link?

If you have any questions, please see our *Innovation/Connectivity* sections on our website: www.cupraofficial.com or e-mail customer-care@cupraofficial.com

Media Control*

Introduction

The **Media Control**¹⁾ app can be used to remotely operate some partial functions in *Radio* mode, *Media* mode and *Navigation* mode. Information can be exchanged between a device and the Infotainment System.

Each one of the functions is operated by means of a Tablet or partially by means of a mobile phone.

Operating requirements:

- A tablet or mobile phone.
- The app must be available on the corresponding device.
- There must be a WLAN connection between the Infotainment System and the device. Select **Menu > Media > Settings >**

WLAN > Share connection via WLAN > Configuration.

Make sure that data transfer for apps is activated:

- From the **SETTINGS** menu > **Data transfer for SEAT apps**, there is a checkbox to activate/deactivate the function and a drop-down menu called **Operation via apps** which controls the level of interaction between the apps and the system. Select **Menu > Settings > Transfer data from mobile devices**.

You can obtain information about the technical requirements in the CUPRA website, in specialised CUPRA dealers or any SEAT dealership.

Telephone functions are not part of the functions of this app.

¹⁾ Availability depends on the country.

Data transmission and control functions



Fig. 164 Media Control Main menu

The Infotainment System can be operated from other seats in the vehicle as follows, with the help of **Media Control**:

- Radio remote control.
- Multimedia playback remote control.

The following information can be exchanged between a device and the Infotainment System, depending on the country and the equipment:

- Navigation destinations.
- Traffic information.
- Social media contents.
- Audio transmission.
- Vehicle data.

- Location-specific information, for example, POIs.

WLAN access point*

Introduction

The Infotainment System can be used to share a WLAN connection with up to 8 devices >>> page 180, Setting up WLAN connection sharing.

The Infotainment System can also use the WLAN hotspot of an external wireless device to provide Internet to the devices connected to the hotspot (WLAN client) >>> page 181, Setting up Internet access.

Note

- **Data transmission may incur charges. Due to the high volume of data exchanged, CUPRA recommends the use of a flat rate mobile phone deal for data transmission. Mobile phone operators can provide the relevant information.**
- **The exchange of data packages over the internet may generate additional costs, depending on your mobile phone rate, particularly if you are abroad (for example, roaming rates).**

Setting up WLAN connection sharing

The Infotainment System can be used to share a WLAN connection with 8 wireless devices.

Establishing the connection with the wireless network (WLAN)

- Press the Infotainment **MENU** button and then press the **Settings** menu.
- Activate the wireless network (WLAN) on the Infotainment System. To do so, press the **WLAN** function button.
- Activate the wireless network (WLAN) on the wireless device that is to be connected. If necessary, refer to the manufacturer's instruction manual.
- Activate the mobile device assignment on the Infotainment System. To do so, press the **Enable WLAN connection** button and activate the checkbox.
- Enter and confirm the network key displayed on the wireless device.

The following settings can also be made on the menu **Share connection**:

Security level: WPA2 encryption automatically generates a network key.

Network key: Network key automatically generated. Press the function button to manually change the network key. The

network key must have a minimum of 8 characters and a maximum of 63.

SSID: WLAN Network name (maximum of 32 characters).

Do not send network name (SSID): Activate the checkbox to deactivate the visibility of the wireless (WLAN) network.

The wireless (WLAN) connection is established. To complete the connection, it may be necessary to enter other data into the wireless device.

Repeat this process to connect other wireless devices.

Wi-Fi Protected Setup (WPS)¹⁾

Wi-Fi Protected Setup can be used to create a ciphered local wireless network quickly and simply.

- Establish the connection with the wireless network (WLAN) >>> page 190.
- Press the WPS button on the WLAN router²⁾ until the warning light on the router starts flashing.

¹⁾ This function depends on the equipment and the country in question.

²⁾ If the WLAN router does not support WPS the network must be configured manually.

- **OR:** Press and hold the WLAN button on the WLAN router until the WLAN light on the router starts flashing.

- Press the WPS button on the WLAN device. The wireless (WLAN) connection is established.

Repeat this process to connect other wireless devices.

Setting up Internet access

The Infotainment System can use the WLAN hotspot of an external wireless device to establish an internet connection.

Establishing the connection with the wireless network (WLAN)

- Activate and check the wireless hotspot on the external device. If necessary, refer to the manufacturer's instruction manual.
- Press the Infotainment **MENU** button and then press the **Settings** menu; **OR** access the **Media** or **Media Control** mode and press the **SETTINGS** menu.

- Press the **WLAN** menu and then enter *Internet access settings on your phone* and activate the checkbox.

- Press the **Find** function button and select the wireless device you want from the list.

- If necessary, enter the network key of the wireless device in the Infotainment System and confirm with **OK**.

Manual settings: To manually enter the network settings of an external wireless (WLAN) device.

The wireless (WLAN) connection is established. To complete the connection, it may be necessary to enter other data into the wireless device.

Note

Due to the large number of different wireless devices in existence, it is not possible to guarantee fault-free operation of all functions.

Operating modes

Radio

RADIO main menu



Fig. 165 RADIO main menu.



Fig. 166 Radio mode: station list (FM).

Press the infotainment button **RADIO** to open the *Radio* main menu »» Fig. 165.

RADIO main menu function buttons

Function button: function	
①	To change the group of memory buttons slide a finger over the memory buttons from left to right or vice-versa
BAND	Allows you to select the frequency band.
STATION LIST	Opens the list of currently receivable radio from the active frequency band.
MANUAL	Allows you to select the frequency manually.
VIEW	Allows you to select the information shown on the screen. Only available in DAB mode.
SETTINGS	Opens the setup menu of the active frequency band (FM, AM or DAB).
◀/▶	Selects the previous or next stored station or of the station list. This setting can be changed in the Radio settings menu (FM, AM, DAB).
1 to 18	Memory buttons »» page 183.
SCAN	Stops the scan function (only visible when the function is under way). It can be activated in the settings menu (FM, AM and DAB).

Information and possible icons

Display: Meaning	
Ⓐ	View the frequency or the name of the station and, where applicable, the radio text. The name of the radio station and the radio text will only be displayed if equipped with RDS and if it is active.
RDS OFF	The RDS radio data service is deactivated.
TP	Traffic information can be retrieved: select Radio > Settings > Traffic station .
📶	No stations with traffic news are available.
★	The radio station is stored on a memory button.
AF off	The tracking of alternative frequencies is disabled.
Note	<ul style="list-style-type: none"> • The availability of AM and DAB bands depends on the country and/or equipment. In the event that the AM and DAB bands are not available, the BAND function button text will not be shown. • Bear in mind that being underground, in tunnels, in areas with tall buildings or mountains can interfere with radio signals. • Foil or metal-coated stickers attached to the windows may affect reception on vehicles with a window aerial.

- Radio stations are responsible for the content of the information they transmit.

Memory buttons



Fig. 167 RADIO main menu.

In the *Radio* main menu, you can store stations from all available frequency wave-lengths on the numbered function buttons. These function buttons are called “memory buttons”.

Functions of the memory buttons

Selecting the station from the memory buttons

Press the memory button corresponding to the desired station.

The stored stations can only be played by pressing the corresponding memory button provided it can be received at your current location.

Functions of the memory buttons

Change memory bank

Move your finger over the screen from left to right or vice-versa.

OR: Press one of the function buttons »» Fig. 167 (A)

The memory buttons are displayed in three memory banks.

Storing the station on the memory buttons

Keep and hold the desired memory button until an audible signal is heard, the station will be stored on this memory button. You can also store a station from a station list.

Storing the station logo on the memory buttons

A station logo can be assigned to the stations stored on the memory buttons.

A logo is automatically assigned from the database if the Advanced radio settings option is enabled. A logo can also be assigned manually from an external data source (USB/SD card).

Media

Introduction

“Media sources” are audio sources containing audio files on various different data storage devices (e.g. CD, memory card, external MP3 player). These audio files can be played by the Infotainment system via their corresponding drives or audio input sockets (internal CD drive, memory card slot, AUX-IN multi-media socket etc.).

Copyright

Audio and video files on data storage devices are usually protected by intellectual property rights, as per the corresponding national and international laws. Be aware of the current legal provisions!

Note

- Do not use memory card adapters.
- CUPRA assumes no liability for any deterioration or loss of files on data storage devices.

MEDIA main menu

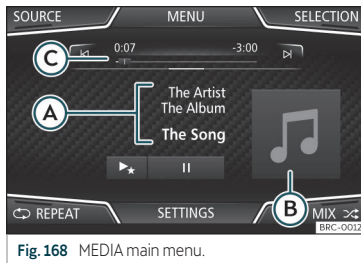



Fig. 168 MEDIA main menu.

Using the *Media* main menu, different media sources can be selected and played.

- Press the infotainment button  to open the *Radio* main menu >>> Fig. 168.

It will continue playing the last media source selected from the same point.

The media source being played is indicated on the dropdown list when pressing the  function button >>> Fig. 168.

If there is no available media source, the *Media* main menu is displayed.



Function buttons of the main Media menu

Function button: function



Indicates the media source being played. Press to select another media source >>> page 186.

: Internal hard drive (SSD) >>> page 189.

: Internal CD and DVD drive >>> page 186.

 : SD memory card >>> page 187.

SOURCE

 : External data storage device connected to the USB port >>> page 187.



: External audio source connected to the AUX-IN multimedia socket >>> page 188.

: Bluetooth® audio >>> page 188.







: External audio source connected by WLAN >>> page 190

SELECTION Opens the track list.

 Changes track in Media mode or fast forward/rewind.



 Playback stops. The  function button changes to .

Function button: function



	Playback is resumed. The  function button changes to  .
	Play more like this. Creates a virtual playlist that includes tracks with a similar rhythm to the one being played if available using Gracenote®.
SETTINGS	Opens the Media Settings menu.
 REPEAT	Repeat all tracks. Repeats all the tracks that are on the same memory level as the track being played at that moment. If in the Media Settings menu the <input checked="" type="checkbox"/> Mix/Repeat including subfolders option is enabled, it also includes the subfolders.
 REPEAT	The current track will be repeated.
 MIX	Random play. Includes all the tracks that are on the same memory level as the track being played at that moment. If in the Media Settings menu the <input checked="" type="checkbox"/> Mix/Repeat including subfolders option is enabled, it also includes the subfolders.

Messages and symbols on the MEDIA main menu

Display: Meaning

	Displays information about the artist name, album name and song title (CD text  , ID3 tag on compressed audio files).
A	Audio CD: displays track information if available via Gracenote® ^{a)} . If no data is available, it only displays Track and the number corresponding to the position it occupies on the data storage device.
B	View of album cover: If there are various covers within the same folder/album, the system only displays one of them. It prioritizes displaying the covers in the following manner: 1. Cover embedded in the file(s). 2. Image in file folder. 3. Image provided by the Gracenote® ^{a)} database. 4. Default icon for the connected device.
C	If playing a video file, by pressing the icon (cover) it can be played on full screen. The playing time so far and time remaining in minutes and seconds. In the case of audio files with variable bit rates (VBR) the remaining time may vary.
RDS Off ^{b)}	The RDS radio data service is deactivated. The RDS can be activated in the FM setup menu.
TP ^{b)}	The TP function is active and can be tuned in.

Display: Meaning

 ^{b)}	There is no traffic news station available.
 ^{b)}	DAB not available.

a) Gracenote® is a database available on the Infotainment system hard drive that contains information on the tracks of different artists and albums. For the user to benefit from the functions offered by Gracenote®, the tracks must contain the artist and/or album data.

b) Depends on the market and unit in question.

Note

- **When the media source is inserted, playing will not start automatically; it is necessary for the user to select the source. Nor will the media source change when it is ejected.**
- **In order to see the different covers inside of the same album/folder, make sure that the tracks contain different information about the Artist or Album in its metadata. If not, you will see the same cover for all of tracks contained in the same album/folder.**

Changing the Media source



Fig. 169 MEDIA mode: change media source.

- From the *Media* main menu, press the **MEDIA** Infotainment button repeatedly to cycle through the available media sources.
- **OR:** From the *Media* main menu, press the **SOURCE** function button >>> **Fig. 169** and select the desired media source.

In the pop-up window, the Media sources not selected are shown as deactivated (in grey).

When a Media source that has already been played is selected again, playback is resumed from the point at which it was stopped.

Optional Media playback sources

Function button: media source

JUKEBOX	Internal hard drive (SSD) >>> page 189.
----------------	--

Function button: media source

CD/DVD	Internal CD/DVD drive >>> page 186.
SD CARD 1	SD memory card >>> page 187.
SD CARD 2	
USB 1	External data storage device connected to the USB port >>> page 187.
USB 2	
AUX	External audio source connected to the AUX-IN multimedia socket >>> page 188.
BT AUDIO	Bluetooth® audio >>> page 188.
WLAN*	External audio source connected by WLAN >>> page 190

i Note

The Media source can be changed in the Track list view: select Media > View.

Insert or eject a CD or DVD

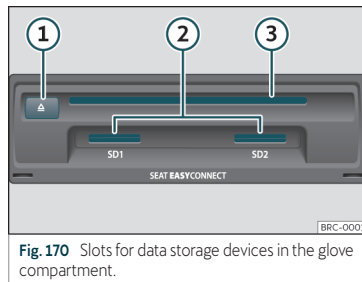

Fig. 170 Slots for data storage devices in the glove compartment.

The driver should refrain from operating the unit while the vehicle is in motion. Insert or change the data storage device before moving off!

The CD and DVD drive can play audio CDs and DVDs and audio data CDs and DVDs.

Insert a CD or DVD

- Hold the CD or DVD with the printed side facing up.
- Push the CD or DVD into the DVD slot >>> **Fig. 170** ③ to the point where it is drawn in automatically.

Eject a CD or DVD

- Press button **⏏** ①.

- The CD or DVD in the drive will be ejected and must be removed within approximately 10 seconds.

Insert or eject a memory card

Depending on the features and the country, the vehicle may have one or two slots for SD cards.

Inserting a memory card

Insert the compatible memory card, beveled edge first and with the label face up (contacts face down), into slot >>> **Fig. 170** ②, until properly inserted.

If a memory card cannot be inserted, make sure it is positioned correctly and is compatible with the unit.

Removing a memory card

The inserted memory cards **must** be prepared for removal.

- From the main *Media* menu, press the **(SETTINGS)** button to open the **Media Settings** menu or press the infotainment button **(MENU)** and then press **(Settings)**, to open menu **System settings**.
- Press the **(Remove safely)** function button. A dropdown menu appears with the following options: SD1 Card, SD2 Card*, USB1 and USB2*. After correctly ejecting the memory

card from the system, the function button becomes inactive (grey colour).

- Press the inserted memory card. The memory card “jumps” to the eject position.
- Remove the memory card.

Unreadable memory card

If a memory card is inserted and the data cannot be read, the relevant warning appears.

External data storage device connected to the USB port

Depending on the features and the country, the vehicle may have one or two USB connections >>> **page 212**.

Audio files on an external data storage device connected to the USB port  can be played and controlled via the Infotainment system.

Where this manual refers to external data storage devices, this means USB mass storage devices containing supported audio files, such as MP3 players, iPods™ and USB sticks.

Only supported audio files are displayed and played. Other files are ignored.

Further operation of the external data medium (changing track, selecting tracks and

playback modes) is described in the appropriate chapters of this manual >>> **page 184**.

Instructions and restrictions

Compatibility with Apple™ devices and other media players depends on the unit.

The USB port  supplies the usual USB voltage of 5 volts for a USB connection.

External hard disks with a capacity greater than 32 GB must be reformatted for the FAT32 file system in some circumstances. You will find the necessary software and information on the Internet.

Take into account all other instructions and limitations regarding requirements for media sources.

Disconnecting

Any connected data storage devices **must** be prepared before their disconnection in order to remove them.

- From the main *Media* menu, press the **(SETTINGS)** button to open the **Media Settings** menu or press the infotainment button **(MENU)** and then press **(Settings)**, to open menu **System settings**.
- Press the **(Remove safely)** function button. A dropdown menu appears with the following options: SD1 Card, SD2 Card*, USB1 and **»**

USB2*. After correctly ejecting the data storage device from the system, the function button becomes inactive (grey colour).

- Now the data storage device can be disconnected.

Note

- **Do not connect an external media player at the same time to play music via Bluetooth® and via the USB port with the Infotainment system, as this could cause playback limitations.**
- **If the external player is an Apple™ device, it cannot be simultaneously connected by USB and by Bluetooth®.**
- **If a connected device is not recognised, disconnect all the connected devices and try connecting the device again.**
- **Do not use memory card adaptors, USB extension cords or USB hubs!**

External audio source connected to the AUX-IN multimedia socket

Depending on the equipment and country there may be an AUX-IN multimedia socket.

The connected external audio source is played over the vehicle speakers and **cannot** be controlled via the Infotainment system controls.

The connection of an external audio source is indicated by **AUX** on the screen.

Connecting an external audio source via Bluetooth®

Bluetooth® Audio mode allows you to listen to audio files being played on a Bluetooth® audio source (e.g., a mobile telephone) connected via Bluetooth® (audio playback by Bluetooth®) over the vehicle speakers.

Conditions

- The Bluetooth® audio source must support the A2DP Bluetooth® profile.
- In the **Bluetooth Settings menu** the **Bluetooth Audio (A2DP/AVRCP) function** must be on. Select **Phone > Settings > Bluetooth**

Starting Bluetooth® audio transfer

- Activate Bluetooth® visibility on the external Bluetooth® audio source (e.g., mobile telephone).
- Lower the base volume on the Infotainment system.
- In the MEDIA main menu, press the **SOURCE** function button and select **BT audio**.

- Press **Search for new device** in order to connect an external Bluetooth® audio source for the first time >>> page 207.

- **OR:** Select a Bluetooth® external audio source from the list.

- Please refer to the instructions on the screen of the Infotainment system and on the Bluetooth® audio source regarding the rest of the procedure.

You may still need to manually start playback on the Bluetooth® source.

When playback on the Bluetooth® audio source is stopped, the Infotainment system remains in Bluetooth® Audio mode.

Controlling playback

The extent to which the Bluetooth® audio source can be controlled via the Infotainment system depends on the connected Bluetooth® audio source.

The available functions will depend on the Bluetooth® Audio profile that the connected external player supports.

With media players that support the AVRCP Bluetooth® profile, playback on the Bluetooth® audio source can be automatically started or stopped when the unit is switched to Bluetooth® Audio mode or to a different audio source. In addition, it is possible to view or change the track via the Infotainment system.

Note

- Due to the large number of possible Bluetooth® audio sources, it is not possible to guarantee fault-free operation of all described functions.
- To play music, do not link the external media player simultaneously to Bluetooth® and the USB interface of the infotainment system, as this can cause limitations during playback.
- Do not connect an external media player to play music via Bluetooth® and via the USB port-↔ >>> page 187 at the same time with the Infotainment system, as this could cause playback limitations.
- If the external player is an Apple™ device, it cannot be simultaneously connected by USB and by Bluetooth®.

Jukebox (SSD)

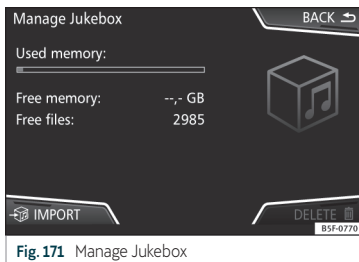

The “jukebox” is located on the hard drive of the Infotainment system (SSD¹⁾.

Compressed audio files (MP3 and WMA) and some video files (Podcasts, AVIs, etc.) can be imported from different data storage devices to the **jukebox** and this used to play them.

The files will only be copied when the engine is running. Copying copy-protected CDs and DVDs is prohibited

Importing files

- In Media mode, press the **SETTINGS** function button and then select **Manage jukebox**.

- Press the **IMPORT** function button.
- Select the desired source from the **Select source** menu.

The data storage device is prepared. This operation may take a few seconds.

- Activate the checkboxes to the right of the files or folders to be imported.
- If **Select all** is activated, all files and folders on the data storage device will be imported.
- Press the **IMPORT** function button.

Depending on the selection, all files and folders will be imported with the indicated name to the **Jukebox**.

If no track information is available, the audio files will be placed in the following folders:

Audio data CD

- **Album**
 - **Unknown albums**
 - **Track.mp3²⁾**
- **Artists**
 - **Unknown artists**
 - **Unknown albums**
 - **Track.mp3²⁾**

»

¹⁾ Solid-State-Drive (SSD).

²⁾ The name and extension of the file are examples.

Functions and progress display during the copying operation

While copying, an animation is displayed along with the progress percentage on the import screen.

Audio data CD: It is not possible to copy and play files at the same time.

- Press the **Cancel** function button to end the import of the whole track that is currently being imported.
- To obtain information on the status of the import, press the **Information** function button.
- Press the **BACK** function button to close the import screen with the progress information.
- When the file import ends, a message will appear.

Deleting files

- In Media mode, press the **SETTINGS** function button and then select **Manage jukebox**.
- Press the **DELETE** function button.
- Activate the checkboxes to the right of the files or folders to be deleted.
- If **Select all** is activated, all the files and folders on the data storage device will be deleted.

- Press the **DELETE** function button. The files and folders will be deleted according to the selection made.
- When the files have been deleted, a message will appear.
- Press the **BACK** function button to close the menu.

Opening stored audio and video files

- Change to **Jukebox** (SSD) content.

When storing the tracks, they are stored under different categories and lists according to the information available.

The tracks saved can be checked and opened from these lists according to different categories.

Jukebox

- Playlist
- Artist
- Album
- Music genre
- Title
- Video
- Non-playable files (an unsupported file has been imported).

Note

- If the Infotainment system cancels a copying operation, check the storage space

on the internal hard drive and check the data storage device.

- Due to copyright laws, before any change in ownership of the Infotainment system, all files stored on the jukebox must be deleted.
- There are several possible reasons why files may be shown as inactive (grey): files that cannot be imported (e.g. images), files that are already stored in the Jukebox or files that take up more space than available in the internal memory.

Connecting an external audio source through WLAN*

WLAN allows wireless connection between an external audio source (for example a smart phone) and the Infotainment system.

To use this connection, the device being connected must have an app compatible with the UPnP (Universal Plug and Play) communication protocol, allowing the app to provide the system with the available media content.

Conditions

- Having a compatible (UPnP) app installed on the mobile device.
- Having the **Enable WLAN connection** option active, which can be found in the wireless connection configuration.

- Pairing the mobile device to the Infotainment system using a password generated by the system. The pairing must be done from the mobile device that you wish to connect to the Infotainment system.

Starting the WLAN audio transfer

- Lower the base volume on the Infotainment system.
- Start the UPnP app or the app for the playback of the WLAN audio source.
- In the MEDIA main menu, press the **SOURCE** function button and select **WLAN**.
- Please refer to the instructions on the screen of the Infotainment system and on the WLAN audio source regarding the rest of the procedure.

Controlling playback

The extent to which the WLAN audio source can be controlled via the Infotainment system depends on the connected WLAN audio source and the application used.

Note

- The Infotainment system does not provide an internet connection, it only establishes a wireless connection between the mobile device and said system.
- Via the WLAN, only the connection between the device and the Infotainment system

tem can be guaranteed, its operation depends on the application itself.

DVD video mode



Fig. 172 DVD main menu.

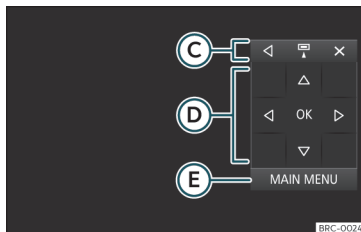

Fig. 173 DVD mode control menu.

Regional code of video DVD

Quite often, the playback of DVD video is limited to certain regions (for example, to the

US and Canada) by so-called region “codes”. These DVDs can only be played on units that are coded for the same region.

The unit’s DVD drive is configured to read the regional code for the region in which the vehicle was originally sold.

Starting the DVD mode

- Insert a compatible DVD in the DVD drive.

The reading of DVD data may take a few seconds.

The DVD’s “intro” (short initial sequence) is played. Next, the different DVD menus are displayed.

Controlling a DVD menu

- Briefly touch the screen to activate the function buttons in the *DVD mode* main menu >>> Fig. 172.

Function button: function

SOURCE	Display and selection of the source.
DVD MENU	To display the control menu and return to the main DVD screen >>> Fig. 173.
A	Chapter display.
B	Displays play time duration and remaining play time.

>>

Function button: function

- : Move the control menu window.
 - : Minimise the control menu window.
 - : Maximise the control menu window.
 - : Close the control menu.
- C**
- Use the arrow buttons to browse the DVD menu. Confirm the selection by pressing **OK**.
- D**
- Press to open the DVD main menu.
- E**
- To move to the next or previous chapter.
- II** Playback stops. The **II** function button changes to .
- Playback is resumed. The function button changes to **II**.
- SET-TINGS** This menu contains the Video (DVD) settings.

Note

- The visual appearance of the DVD film menus and the menu options which it offers are the responsibility of the DVD manufacturer.
- The difference in behaviour of some films when using the same mode is the responsibility of the DVD manufacturer.
- You may not be able to play video DVDs which you have burned yourself.

- The Infotainment system screen only displays the image when the vehicle is stopped. Whilst in motion, the screen disconnects (the image), but the audio remains active.

Images



Fig. 174 Images main menu.

Using the *Images* menu, image files can be viewed (e.g. photos) individually or as a slideshow.

The image files must be stored on a compatible data storage device (e.g., a CD or an SD card).

- Press the Infotainment **MENU** button and then select the **Images** context.
- Press the **SOURCE** function button to select the source where the pictures in question are located.

Function button: function

- SOURCE** Viewing and selecting the source.
- SELECTION** Opens a list of image files.
- The image viewed was obtained via GPS localisation and upon pressing this function button, the navigator menu opens to start a route to this destination.
- Rotate the view of the image to the left or the right.
- Reset the view of the image.
- II** To stop the playback of a slideshow. The **II** function button changes to .
- To continue the playback of a slideshow. The function button changes to **II**.
- To change to the **PREVIOUS** or **NEXT** image.
- The same function can be performed by sliding your finger horizontally across the screen.
- SETTINGS** Open the Image settings menu.

Enlarging or reducing the view

To enlarge or reduce the view of the image displayed:

- Stretch or reduce the image on the screen using 2 fingers.

Rotating the view/image

To rotate an image, in addition to the buttons provided for this (↻) / (↺), you can also press on the screen (e.g. with your thumb) and, while continuing to press with your thumb, slide another finger (e.g. your index finger) around it like a compass either clockwise (to rotate the image to the right) or anti-clockwise (to turn the image to the left). This will rotate the image 90° with respect to its current position.

Requirements for viewing images

Image files	Maximum resolution
BMP	4MP
JPEG	4MP (Progressive Mode)
JPG	64MP
GIF	4MP
PNG	4MP

Navigation

Introduction

General information

Using all the data available, the Infotainment system calculates the optimum route to the destination.

The destination is defined by entering an address or a point of interest, e.g. a petrol station or hotel. Traffic reports, if any, will also be taken into account in the route calculation (dynamic route guidance »» page 200).

Spoken instructions and visual guidance on the navigation unit and on the instrument panel will direct you to your destination.

ⓘ CAUTION

The navigation announcements played may be inaccurate (e.g. due to out-of-date navigation data).

Instructions for navigation

When the Infotainment system is unable to receive any data from GPS satellites (due to dense tree canopy, underground car park), navigation can still continue using the vehicle sensors.

Possible limitations in navigation

In areas that are not or are only partially digitised on the data storage device (e.g. insufficient definition of one-way streets and road categories), the Infotainment system will still attempt to provide route guidance.

Navigation area and updating navigation data

Roads and streets are subject to constant change (e.g. new roads, changes to street names and building numbers). Therefore, if the navigation data is not updated, then errors or inaccuracies may occur during guidance.

CUPRA recommends updating navigation data on a regular basis. The navigation information can be obtained at a specialised CUPRA dealer or any SEAT dealership.

Updating and installing navigation data

The Infotainment system is equipped with an internal navigation data memory. The required navigation data are already installed on the system.

The Infotainment system always requires the navigation data that is currently valid for this unit in order to allow all functions to be used in full. Using an old version may lead to errors during navigation.

Updating navigation data

The navigation data must be installed after downloading. Navigation is not possible from the memory card. »

Installing navigation data

The installation process takes about 2 hours.

If the Infotainment system is switched off, the installation process is paused and will automatically resume when switched back on.

- Switch the ignition on.
- Insert the memory card containing the navigation data >>> page 187.
- Press the Infotainment **MENU** button and then select the **System** context.
- In the **System settings** menu, press the **System information** function button.
- Press **Update software** to import the stored navigation data.
- Follow the instructions displayed on the screen.

Once installed, the memory card can be removed. The memory card must be prepared for removal >>> page 187.

ⓘ CAUTION

Do not remove the memory card while the navigation data is being installed. The memory card may be irreparably damaged!

ⓘ Note

- The navigation memory card may not be used as memory storage for other files. The Infotainment system will not recognise the files saved on it.
- CUPRA recommends a CLASS 10¹⁾ memory card for the use of navigation data. The use of other memory cards could limit its operation.

Navigation main menu

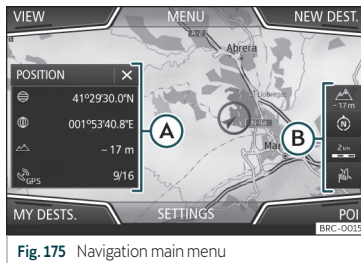

Fig. 175 Navigation main menu

The *Navigation* main menu allows you to select a new destination, call up a previously used or stored destination and search for points of interest.

Opening the main Navigation menu

- Press the Infotainment system button **NAV** to open the last menu that was open in navigation.

Function buttons and messages on the main Navigation menu

Function button: function

- A** The split screen is displayed >>> page 199.
- B** Messages and function buttons on the map display >>> page 200.

NEW DESTINATION: To enter a new destination >>> page 195.

ROUTE: During route guidance >>> page 196.

MY DESTS.: To activate or manage stored destinations >>> page 196.

POI: Search for points of interest (car parks, fuel stations and restaurants) within a particular search area >>> page 198.

VIEW: To modify or activate or deactivate the split screen and show POI >>> Fig. 175 **A** >>> page 198.

SETTINGS: Open the **Navigation Settings** menu.

¹⁾ The speed class of an SD card.

New destination (enter destination)

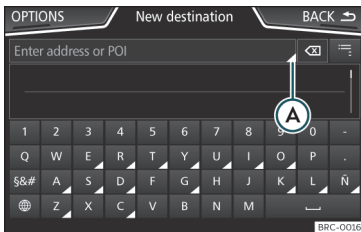

Fig. 176 Search screen.

- In the **Navigation** main menu, press the **New destination** function button.
- Press the **Options** function button and select the required type of destination (**Search**, **Address**, **POI on the route** or **On map**).
- Using voice control*, if you say Town, street and number, without pauses, and then the instruction "Start Route Guidance" a route to the given destination will start.

Search

Search for addresses and Points of Interest using the keypad to enter them »» Fig. 176.

For cities, post codes and points of interest, the full details must be entered. You can also search for points of interest by names or cat-

egories. When necessary, enter the name of the city to refine the search.

»» Fig. 176

- (A) Press to open the cursor buttons (<, >), which allow you to move within the text.

Address

After entering a country and a town, you can start navigating towards the centre of the selected town.

When narrowing down the destination address, **please note** that every entry restricts the available range of subsequent selections. For instance, if the street you are looking for is **not** in the postcode area you have selected in a previous window, you will not be able to find the street at the street selection stage.

Function button: function

- Country**: To select the desired country.
- City**: To enter the desired city or postcode.
- Street**: To enter the desired street name.
- House number**: To enter the desired house number.
- Junction**: To select the desired intersection.
- Last destinations**: Open the **My destinations** menu »» page 196.
- Start**: Start route guidance to the selected address.

On the map

- Select the destination on the map or enter it using GPS coordinates and confirm with **OK**.

Function button: function

- Save**: To save the selected point of interest in the destination memory »» page 196.
- Edit**: To edit a destination or to enter another destination.
- Route options**: To adjust route options, see **Navigation Settings > Route options**.
- Start**: Starts guided navigation to the selected point of interest.

After starting route guidance



Fig. 177 Route calculation.

After starting route guidance, the route to the first destination will be calculated.

The calculation will be performed in accordance with the data selected in the **Route options** menu.

After starting route guidance, three **alternative routes** will be suggested depending on the selected setup >>> **Fig. 177**. These 3 routes correspond to the selectable route options: *Economical*, *Fast* and *Short*.

Route criteria: Meaning

Blue route: *Economical route*, the route is calculated by taking into consideration economic factors.

Red route: *Fastest route* to the destination, even if it is necessary to make a deviation.

Orange route: *Shortest route* to the destination, even if it results in longer travelling time. The route may have unconventional sections such as secondary roads.

- Select the desired route by pressing it.

Once the route has been calculated, the system gives the first navigation announcement. Up to 3 navigation announcements are given before a turn.

- Press the adjustment knob >>> **Fig. 151** ¹² to listen to the last audible navigation instruction.

A navigation announcement informs you when you have reached your “destination”.

A navigation announcement informing you that you have reached the “destination area” is given if the exact destination cannot be reached because it is located in a non-digitalised area.

During **dynamic route guidance**, you receive information about reported traffic congestion on the route. An additional navigation announcement is given if the route is recalculated due to traffic congestion.

During a navigation announcement, you can change its volume using the button  >>> **Fig. 151** ³.

For other adjustments to the navigation recommendations, select **Navigation > Settings > Navigation announcements settings**.

Note

- If you miss a turning during route guidance and are currently unable to turn back, keep on driving until the navigation system offers a new route.
- The quality of the navigation recommendations given by the Infotainment system depends on the navigation data available and any reported traffic problems.

Route

In the *Navigation* main menu, press the **Route** function button.

The **Route** function button is only displayed with route guidance activated.

Function button: function

Stop route guidance: Aborts current route guidance.

Enter destination: To enter a new destination or a new stopover >>> page 195.

Congestion ahead: To exclude a section (of 0.2 to 10 km in length) from the current route, e.g. to avoid congestion. To cancel the exclusion, press the **Route** function button and then **Cancel congestion**.

Change route^{a)}: The map of the calculated route appears and by holding a finger on the route and dragging the finger across said map, the route is changed to the road(s) that you want and the new route is then recalculated.

Route details: View route information for current route.

^{a)} Only available for the model: Navi System Plus

My destinations (destination memory)

The stored destinations can be selected from the **My destinations** menu.

- Press the **My dests.** function button in the main *Navigation* menu.

- Select the desired function button.

Store position, **Routes**, **Destinations**,
Last destinations or **Home address**.

Store position

- By pressing the **Store position** function button, the vehicle's current position is stored as a **Flagged destination** in the destination memory.
- Mark the **Flagged destination** in the destination memory.
- Press the **Store** function button.

The name can be changed in the following input window. Press the **Store** function button to store the destination.

Routes

In the **Route** mode, you can define various destinations (final destination and stopovers).

The **starting point** of a route is always the current vehicle position determined by the Infotainment system. The **destination** is the end point of a route. **Stopover destinations** are driven to before the destination.

- In the **Navigation** main menu, press the **My Dests.** function button.
- Press the **Routes** function button. The routes stored previously will appear.

If you have not stored any routes or want to create a new route, press the **New route** function button and then follow the instructions as for a new destination, before pressing **Store**.

Pressing on a stored route brings up the following function buttons:

Function button: function







Delete: To delete a stored route.

Edit: To edit and store a route.



Start: To start route guidance.

Function buttons and indications in the New route or Edit route menu

Function button or message: function or meaning

	Stopover.
	Destination.
	Estimated time of arrival at destination.
	Calculated distance to destination.
	Travelling time.
	Distance to the next stopover.

Press on the destination to display the function buttons.

	Delete destination.
	To start guidance direct to the selected destination. Destinations that come before the selected destination are ignored.
	To open the detailed view of the destination in question.

Available function buttons.

New dest.	To add a new destination to the tour.
Destinations	To add a new destination from My destinations to the tour.
Storing	To store the created tour in the tour memory.
Start	To start route guidance.
Calculate	To update calculated distance and estimated arrival time. ^{a)}
Stop	To stop route guidance to the active destination. ^{b)}
	To move a stopover or a destination to another position on the list. Press and drag to move the destination.

^{a)} This function button is only displayed with route guidance activated and when a destination has been added to the tour.

^{b)} This function button is only displayed with route guidance activated. »

Last destinations

View of destinations for which a route has already been started.

My destinations

- Press the Options function button and select the desired function button.

Function button: function

Destination memory: View of destinations stored manually and from imported vCards »» page 201, Importing vCards (electronic business cards).

Favourites: View of destinations stored as favourites.

Contacts: View of entries in the phonebook that have a stored address (postal address).

Home address

Only one address or position can be stored as the home address at any one time. The stored home address can be edited or overwritten.

If a home address has already been stored, route guidance will be started to the stored home address.

If a home address has not yet been stored, an address can be assigned as the home address.

Assigning the home address for the first time:

Position: Press to store the vehicle's current position as the home address.

Address: Press to enter the home address manually.

Editing the home address:

The home address can be edited in the **Navigation settings > Manage memory** menu.

Points of interest (POI)

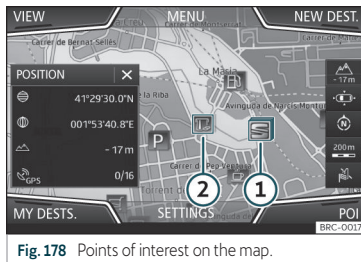

Fig. 178 Points of interest on the map.

The points of interest saved in the navigation data memory are divided into different point of interest categories. Each point of interest category is assigned a symbol for display on the map.

If a database of points of interest has been imported into the Infotainment system,

»» page 202, Importing Personal POI the category **Personal POI** is also shown.

In the **Map settings** menu, the categories of points of interest to display on the map can be configured. Up to 10 categories of points of interest can be selected.

Selecting a point of interest on the map

Function button: function

- 1 There are several points of interest in the area. Press this symbol to open a list of points of interest.
- 2 The only point of interest in this zone. Press the symbol to open the detailed view of the point of interest.

Quick POI search

In the **Navigation** main menu, press the **POI** function button and the three main categories will appear. Alternatively, enter the name of the point of interest to be searched using the new destination keypad, or press **Search nearby** on the map »» table on page 199.

View

In the **Navigation** main menu, press the **View** function button.

Function button: function

2D  Map display in two dimensions (conventional).

Map display in three dimensions (bird's eye view).

3D  Buildings are also displayed in three dimensions. The places of interest and well-known buildings are shown in detail and in colour.

 To display the destination on the map.

 To display the route on the map.

Auto / Day / Night To change between day and night format.

Split screen Press to display the split screen >>> page 199.

POI Display points of interest on the map.

^{a)} This function button is only displayed with route guidance activated.

Split screen

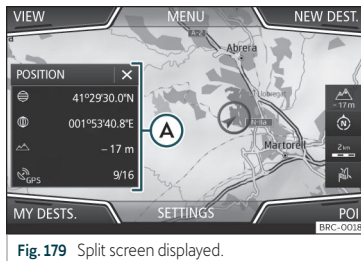

Fig. 179 Split screen displayed.

The split screen >>> Fig. 179 (A) may display any of the information described below:

- Press on the name of the split screen to select a display option.

Function button: function

Audio: Indicates the selected audio source.

Compass: Displays a compass with the current travelling direction and indicates the current position of the vehicle (street name).

Manoeuvre: Displays a list of the next manoeuvres, POIs or TMCs on the route and pressing them brings up additional information

Most frequent routes^{b)}: Information on the user's most frequent routes.

Function button: function

Position: current vehicle position in coordinates and GPS status (satellite reception).

^{a)} This function button is only shown when route guidance is not active or when predictive route guidance is active.

Press the  function button to close the split screen.

At any moment during navigation, pressing inside the map will make a pop-up menu appear with the following functions:

Function button: function

Street name or coordinates: shows the details of the point selected on the map.

Only when you press on an icon on the map:

POI: name of the point of interest (when only one appears on the map).

Group of POIs: more points of interest (when you press on the map on various POIs grouped together).

Favourite: name of the favourite.

Home: Home address.

Start route guidance: starts guidance directly.

Add stopover destination: only when you have an active route.

Search nearby: enters in the search menu, but only for the area around the point selected on the map. »

Function button: function

Demo mode start (only when demo mode is active)

Map display

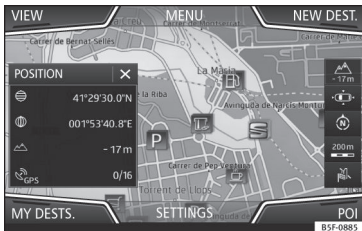

Fig. 180 Messages and function buttons on the map display.

Function buttons and messages on the map display.

To activate function buttons and , press function button .

Function button: function

	Current altitude indicator.
	To centre the vehicle position on the map.
	To centre the destination on the map. This function button is only displayed if either <i>Display destination on map</i> or <i>Display route on the map</i> is selected >>> page 198.

Function button: function

	To change the orientation of the map (north-facing or direction of travel). This function is only available in 2D mode.
	View map scale. Turn the setup button or move your fingers together/apart on the touchscreen to change the scale of the map.
	To select automatic scaling. If the function is active, the symbol is displayed in blue.
	Briefly zooms in on the map. After a few seconds, it automatically returns to the last selected scale.
	It can mute or repeat the last announcement, or can change the announcement volume.

Road signs: Depending on the vehicle's equipment, the road signs stored in the navigation data are displayed. Select **Navigation > Settings > Map > Show road signs**.

Traffic reports and dynamic route guidance to the destination (TRAFFIC)

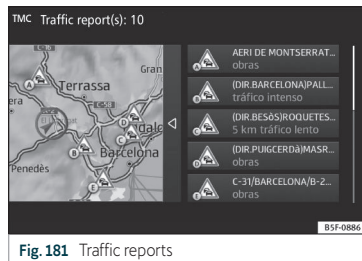

Fig. 181 Traffic reports

The Infotainment system constantly receives traffic reports (TMC/TMCpro) in the background, provided a TMC traffic news station can be received at the current location. The station being listened to does not have to be the traffic news station.

List of available traffic reports

- Press the Infotainment **MENU** >>> **Fig. 151** button and then select the **Traffic** context.

Dynamic route guidance

In order for dynamic route guidance to function, **Dynamic route** must be activated in the route options.

If during route guidance a traffic report is received that affects the route being travelled,

an alternative route will be searched for if the Infotainment system calculates that time can be saved.

Traffic reports on map (selection)

Symbol: Meaning

 : Slow traffic

 : Traffic jam

 : Accident

 : Slippery road surface (ice or snow)

 : Slippery road surface

 : Danger

 : Road works

 : Strong wind

 : Road closed to traffic

During route guidance, traffic congestion that does **not** affect the route calculated is displayed in grey.

Predictive navigation

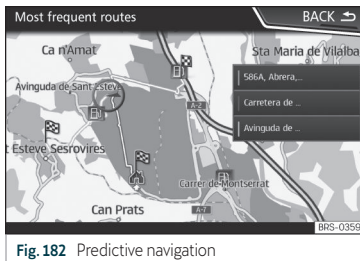



Fig. 182 Predictive navigation

When you activate Predictive navigation, the system detects and stores in the background routes that are frequently followed, without them being active destination routes. This function has no navigation announcements unless the user requires them, getting them by pressing the adjustment knob >>> Fig. 151 .

- On the main screen of the Navigation menu, in the pop-up window, press the **Frequent routes** button. To display frequently followed routes press the **Show on map** button >>> Fig. 182.

Importing vCards (electronic business cards)

Importing vCards to the destination memory

- Insert the data storage device with the stored vCards or connect it to the Infotainment system >>> page 184.
- Press the **SETTINGS** function button in the main *Navigation* menu.
- In the **Navigation settings** menu, press the **Import destinations** function button.
- Select the data carrier with the vCards saved in the list.
- Press **Import all vCards from this folder**.
- Confirm the import notice with the **OK** function button.

The saved vCards will now be in the destination memory >>> page 196 and may be used for navigation.

Note

Only one address per vCard can be imported. In the event any vCards have multiple addresses, only the main address will be imported.

Importing Personal POI

Importing the Personal POI to a points of interest destination memory

- Insert the data storage device with the stored Personal POI or connect it to the Infotainment system >>> page 184.
- Press the Infotainment button **(NAV)** and then select **Settings**.
- In the **Settings** menu, press the **(Manage memory)** function button.
- Press **(Update my POIs)** and then press **(Update)** and **(Next)** to import the Personal POIs.
- Confirm the import notification with the **(OK)** function button.

The stored Personal POI are now in the points of interest destination memory >>> page 198 and can be used for navigation purposes.

The stored Personal POI can be deleted in the **Navigation Settings** menu.

Navigation with images

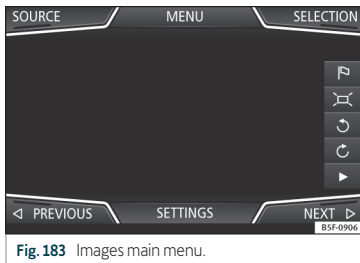

Fig. 183 Images main menu.

Selecting an image and starting route guidance

Bear in mind the requirements and formats of the compatible images.

- Insert the data storage device with the stored images or connect it to the Infotainment system.
- Press the Infotainment **(MENU)** button and then select the **Images** context.
- Press the **(SOURCE)** >>> Fig. 183 function button and select the data storage device where the images are stored.
- Select the desired image.

- If the image displayed was taken using GPS localisation, the **(P)** function button will appear. Press to start guidance to a destination.

Route guidance in Demo mode

If demo mode is activated in the **Navigation Settings** menu, an additional pop-up window opens when you start route guidance.

- Pressing the **(Demo mode)** function button starts a “virtual route guidance” to the destination you have entered.
- If you press the **(Normal)** function button, a “real route guidance” starts.

Navigation in Offroad mode*¹⁾

Introduction

Offroad* navigation is a function for offroad driving that provides directions in “non-digitised areas” at low speeds.

Non-digitised areas are areas about which the system does not have information for the streets or terrain. It does not detect streets, buildings or natural limits such as mountains

¹⁾ Only available for the model: Navi System Plus

or rivers, although they may be shown on the map.

Offroad* navigation is not suitable for driving on conventional roads as it does not detect one-way streets, motorway entries or similar.

Offroad Navigation Menu

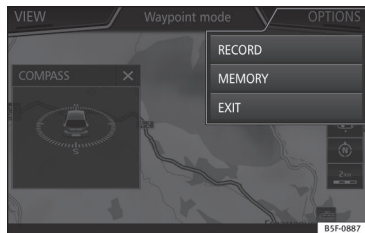

Fig. 184 Offroad Navigation Menu start

Press the **SETTINGS** function button in the main Navigation menu.

- In the menu, press the **Waypoint mode** function button.
- The Offroad Navigation menu opens >>> **Fig. 184**.

Function buttons in the Offroad Navigation menu

Function button: function

RECORD: Initiates the plotting of an Offroad tour.

MEMORY: Opens a list allowing the selection of a stored Offroad tour.

EXIT: Ends Offroad navigation.

Recording an Offroad tour

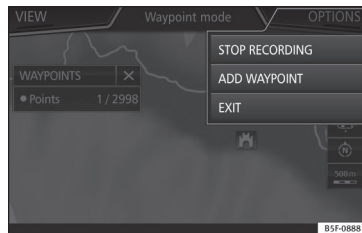

Fig. 185 Recording an Offroad tour

An Offroad tour is formed by a series of stored *waypoints*.

Starting recording

- In the Offroad Navigation menu, in the pop-up window press the **RECORD** pop-up button.

- In the pop-up window, the user is able to plot the tour with a given destination or start plotting the route without giving a final destination.
- Starts plotting the route.

The **offroad** markers can be recorded by indicating a manual waypoint.

- In the Offroad Navigation menu, press the **ADD WAYPOINT** function button. The tour waypoints defined manually are shown on the map by a marker.

Ending recording

- Press the **STOP RECORDING** function button in the main Offroad Navigation menu.

Managing stored Offroad tours

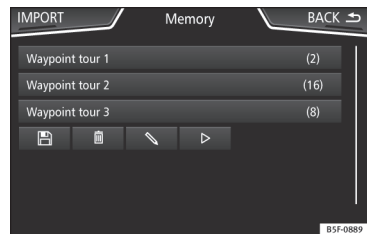





Fig. 186 Offroad Navigation menu, stored tours >>

- Press the **MEMORY** function button in the Offroad Navigation menu.
- A list of stored Offroad tours opens, if there are any.

When a tour is selected, the following icons will appear >>> **Fig. 186**:

-  Export the tour to an SD card.
-  Edit the name of the tour.
-  Delete the tour.
-  Load tour

Function button: function

IMPORT: allows the import of an Offroad route in ".GPX" format.

Loading an Offroad tour

When the Offroad tour is selected, press Play  and the selected tour will be loaded onto the Navigation system.

Creating an Offroad tour

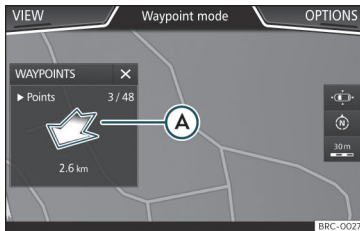

Fig. 187 Offroad route guidance mode

Start route guidance

- Loads the stored Offroad tour.
- Starting off in a stored route is not detected by the system automatically.

Settings

Function button: function

Invert: Reverses the direction of the stored Offroad tour.

Next point: Starts the Offroad tour from the nearest point.

Start: Starts the complete Offroad tour.

When route guidance starts, the system switches to the map view.

Stopping route guidance

- Press the **Options** button on the screen and then press **Stop**.

End waypoint navigation

- Press the **EXIT** function button in the Offroad Navigation menu.

WARNING

Terrain features are disregarded during route guidance Drive slowly and following the instructions in order to perform the manoeuvre as far as possible!

- The general direction of travel is indicated straight ahead by direction arrows in the Infotainment System pop-up window >>> **Fig. 187** .

Note

If an Offroad tour is being recorded, this is automatically stored if Offroad navigation is discontinued.

Vehicle Menu

Introduction to using the Vehicle menu

By pressing button **CAR** of the infotainment system you will access its main menu with the following options:

- VIEW
- MINIPLAYER, in the top right corner (Radio or Media function if the HDC descent control* is not active).
- PREVIOUS-NEXT (to change screen)
- SETTINGS >>>  page 33

With the function button **VIEW** you can access the following information:

Instrument panel

Press the **Instrument Panel** button to choose from the various display options and customise the information that appears in the Digital Cockpit >>> page 95:

- **Automatic Display:** default information depending on the selected *Driving Mode*.

- **Classic Display:** the entire lengths of the revolutions per minute and speedometer needles are shown.
- **Views 1, 2, 3:** customise the information that appears in the digital cockpit. Only 2 of these items of information can be displayed at the same time, but the user chooses which to display, and in what order, by moving the finger vertically over the dials. Depending on the version, the **Views** can be memorised by exiting the menu or keeping the **View** button pressed.

Sport*

If the corresponding equipment is available, the information that appears in the Sport option is the following:

1. Instantaneous power expressed in kW
2. G forces
3. Turbo pressure, expressed in bar ("bar"), kilopascals ("kPa") or in pounds per square inch ("psi"). Press the Setup button to change the units of pressure.
4. Coolant temperature
5. Oil temperature

Only 3 of these items of information can be displayed at the same time, but the user chooses which to display, and in what order, by moving the finger vertically over the dials.

Press the **Next** button to display the **Lap timer** menu¹⁾.

Offroad*

If the corresponding equipment is available, the information that appears is the following:

1. Compass.
2. Altimeter: altitude above sea level.
3. Turning angle of steered wheels.
4. Coolant temperature.
5. Lubricating oil temperature

Only the altimeter and 2 more of these items of information can be displayed at the same time, but the user chooses which to display, and in what order, by moving their finger vertically over the dials.

Consumers

By pressing the **CONSUMERS** button, information on the status of the vehicle's main consumption devices is obtained. It is shown »

¹⁾ This lap timer is independent of the one that appears on the instrument panel.

via a consumption indicator bar in l/h (gal/h)¹⁾.

Driving data

The onboard computer is equipped with 3 memories that work automatically. In these memories you can see the distance travelled, average speed, time passed, average consumption and autonomy of the vehicle.

Ecotrainer*

If the corresponding equipment is available, the ECOTRAINER will provide information on driving style. The information on driving style is only evaluated and displayed when moving forward.

Vehicle status

Press the **Vehicle status** button to access information on the **Vehicle status** messages and **Start-Stop system**. The Vehicle status messages are displayed, in addition to being specified on the corresponding button.

¹⁾ In the case of Gas (CNG) vehicles, the units are in kg/h.

Telephone

General information

The Telephone functions described below can be used through the Infotainment system if there is a mobile telephone connected to it via Bluetooth® >>> page 208.

In order for the mobile telephone to be able to connect to the Infotainment system the telephone must be equipped with **Bluetooth®**.

If there is no mobile telephone connected to the Infotainment system, the telephone management system will not be available.

The instructions shown on the screen for the telephone menus will depend on the mobile telephone used. There may be variations.

Only use compatible Bluetooth® devices. For further information on compatible Bluetooth® products, ask your nearest specialised CUPRA dealer, any SEAT dealership or check on the internet.

Use the instruction manual of the mobile telephone and of any accessories.

If you detect any operating issues between your mobile telephone and the Infotainment

system, restart your mobile by switching it off and on again.

Some functions and setup can only be performed when the vehicle is stopped and are not available on all mobile telephones.

WARNING

General, mandatory, legal and country-specific instructions and laws for the use of mobile phones inside the vehicle must always be considered.

WARNING

Speaking by telephone and using the mobile telephone management system whilst driving can distract you from the road and cause an accident.

- Always drive carefully and responsibly.
- Select volume settings that allow you to easily hear signals from outside the vehicle at all times (e.g. emergency services sirens and horns).
- In areas of little or no coverage or, in some cases, in a tunnel, garage or underpass, your call may be cut off and you may not be able to make even emergency calls.

WARNING

If a mobile telephone is not secured or is incorrectly secured in the vehicle, it could move around the passenger compartment in the event of a sudden driving manoeuvre or emergency stop, resulting in injury.

- While the vehicle is in motion, always secure the mobile telephone properly outside the airbag deployment zone.

WARNING

Mobile telephones may interfere with and alter the correct operation of pacemakers if they are carried directly over them.

- Maintain a minimum distance of at least 20 centimetres between the aerials of the mobile telephone and the pacemaker.
- Do not carry your switched-on mobile telephone in your breast pocket directly over the pacemaker.
- If you suspect interference, switch off the mobile telephone immediately.

CAUTION

High speeds, poor weather or road conditions and the quality of reception can all affect the audio quality of a telephone conversation in the vehicle.

Note

- Restrictions on the use of devices using Bluetooth® technology may apply in some countries. For further information, contact the local authorities.
- If you wish to connect a device to the telephone management system via Bluetooth® technology, consult the safety warnings in its instruction manual. Only use compatible Bluetooth® devices.

Places with special regulations

Switch off the mobile telephone and the mobile's Bluetooth® function in places with a risk of explosion. In the majority of cases, these places are signposted, but not always clearly >>>  in General information on page 206. They include, for example:

- the vicinity of chemical pipelines and tanks
- The lower decks of boats and ferries.
- In the proximity of vehicles that run on liquid gas (such as propane or butane).
- places where the air is laden with chemicals or particles such as flour, dust or metal powder.
- all other places where the vehicle engine must be switched off.

WARNING

Switch off the mobile phone in areas with a risk of explosion! The mobile telephone can automatically connect to the mobile telephone network again if it loses the Bluetooth® connection to the telephone management system.

CAUTION

In areas where special regulations apply or the use of mobile telephones is prohibited, both the telephone and the telephone management system must be switched off. The radiation produced by the mobile telephone when switched on may interfere with sensitive technical and medical equipment, possibly resulting in a malfunction or damage to the equipment.

Bluetooth®

Bluetooth® technology allows a mobile telephone to be connected to your vehicle's telephone management system. In order to use the telephone management system with a mobile telephone with Bluetooth® technology, it is first necessary to pair them.

Some Bluetooth® mobile telephones detect and automatically connect when turning on the ignition if a connection has been previously established. For this to take place the telephone must be switched on and its



Bluetooth® function activated, and there must be no active Bluetooth® connection with other devices.

Bluetooth® connections are free.

Bluetooth® is a registered trademark of Bluetooth® SIG, Inc.

Bluetooth profiles®

When a mobile phone is connected to the telephone management system, a data exchange takes place via one of the Bluetooth® profiles.

- **Hands-Free Profile (HFP):** When connecting a mobile telephone to the phone manager through the HFP the calls can be managed via the Infotainment system.
- **Audio profile (A2DP):** This profile makes it easier to transmit audio to the infotainment system with stereo quality. This function may require connecting additional profiles for managing and controlling audio playback.
- **Phone book access profile (PBAP):** Serves to download phone book contacts from the mobile telephone to the Infotainment system.
- **Message profile (MAP):** Serves the download and synchronise short messages (SMS) of the mobile telephone to the Infotainment system.

Note

To prevent them from being heard through the speakers, the button and mobile telephone alert tones must be disconnected. Where necessary, disconnect the headset from the mobile telephone you wish to connect to the system.

Pairing and connecting a mobile telephone to the Infotainment system

In order to manage a mobile telephone via the Infotainment system, it is necessary to pair both devices **once**.

For your safety, we recommend you make the link when the vehicle is stationary. In some countries it is not possible to perform the pairing with the vehicle running.

Conditions

You must guarantee the following setup in the mobile phone and the Infotainment system:

- The ignition must be switched on.
- The **Bluetooth® function** of the mobile telephone and the Infotainment system must be active as well as visibility.
- The **keypad lock** on the mobile telephone must be deactivated.

Follow instructions in the manual for the mobile telephone.

During the pairing process, it is necessary to enter data via the mobile telephone's keypad.

Pairing a mobile telephone

- Make sure the mobile device's Bluetooth® function is activated and visible.
- Press the infotainment **PHONE** button.
- Press the **Find telephone** > **Results** function button.

OR:

- Press the infotainment **PHONE** button.
- Press the function button **Setup** > **Select mobile phone** > **Results**.

OR:

- Press the infotainment **PHONE** button.
- Press the **Settings** > **Bluetooth** > **Find devices** > **Results** button.

The name of the Bluetooth® function of your Infotainment system will be displayed on the main *Telephone* screen and you can edit this name via the **Bluetooth settings** menu

The search process can take up to 1 minute. On the screen, the system will dynamically update the names of the Bluetooth® devices found.

As soon as the search is completed, the names of the Bluetooth® devices found are displayed on-screen.

- Select the Bluetooth® device you want to connect on the infotainment system. In certain circumstances, it is possible that to finish the connection between the two devices, you must enter additional data in the mobile telephone and Infotainment system.
- Use your mobile telephone to enter and confirm your PIN code, as indicated in the display of the infotainment system.
- If more Bluetooth® profile pairing requests are received on the mobile telephone, make sure to reply to them.

OR:

- Compare the PIN code shown on the display of the Infotainment system with that shown on the mobile telephone. If they match, confirm on **both** devices.

When the pairing has been finalized correctly, the *Telephone* main menu will appear. The phone book, call list and SMS messages stored in the mobile phone will be loaded once the requests have been accepted in the mobile phone. After downloading, the data will be available on the Infotainment system.

Pairing and connection of mobile telephones

You can pair up to 20 mobile telephones to the Infotainment system, but there can only be two mobile phones simultaneously connected as hands-free, and a third device connected to the Bluetooth® audio profile at any time.

When the Infotainment system is switched on, it automatically connects to the last connected mobile telephone. If it is not possible to connect to this mobile telephone, the telephone management system will try to automatically connect to the next mobile telephone on the list of paired devices.

The **maximum** range of the Bluetooth® connection is approx. **10 meters**. The active Bluetooth® connection disconnects if this distance is exceeded. The connection is **automatically** re-established as soon as the device is once again within Bluetooth® range.

WARNING

Do not perform the pairing and connection process while driving. This may cause an accident!

Note

- It may be necessary to confirm the phone book data and SMS transfer request on the mobile telephone.

- Check that there are no requests pending acceptance in your mobile phone. If there are, this could block some of the functions in the Telephone menu.

Telephone main menu



Fig. 188 Phone main menu.

Assign a user profile

The data from the phonebook, the call lists and the stored speed dial buttons are assigned to a user profile and remain stored on the telephone management system. This information will be available every time the mobile telephone is connected to the telephone management system.

After the first connection, it will take a few minutes for the data from the phonebook of the linked mobile phone to be available in the Infotainment system. The next time that the mobile telephone is connected (e.g. on

the next journey) the phonebook is updated automatically.

If any entries in the mobile phonebook have been modified while connected, a manual update of the phonebook data can be initiated from the **User profile settings** menu.

Telephone management can store a maximum of 4 user profiles for mobile telephones. If you wish to link/connect another mobile phone, the oldest user profile will automatically be replaced.

Telephone management system function buttons

- Press the infotainment button  to open the *Phone* main menu.

Function button: function

①	Name of connected mobile telephone. Press the icon to the left to connect or pair with another mobile telephone.
②	Speed dial buttons, to which telephone numbers from the phonebook may be assigned respectively.
③	To change to another telephone connected to the hands-free profile. This button will only be visible when there are two telephones connected as hands-free. The active user profile corresponds to the telephone appearing on the screen.

Function button: function

DIAL NUMBER	To open the number pad and enter a telephone number » page 211.
CONTACTS	To open the phonebook of the connected mobile telephone.
SMS	To open the menu for SMS messages.
CALLS	To open call lists of the connected mobile telephone » page 211.
SETTINGS	To open the Telephone settings menu.

Display and symbols of the telephone management system

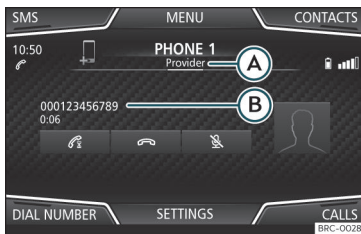















Fig. 189 Active call.

Display: Meaning »»» Fig. 189

	Name of the mobile network operator (provider) to which the mobile telephone is connected.
	View of stored telephone number or name. If the name stored in the phonebook has an assigned photo, it can be displayed: select Telephone > Settings > User profile > Show pictures for contacts* .
	Press to accept a call.
	Press to end a call.
	OR: Press to reject an incoming call.
	Press to mute or to reactivate the ring tone during an incoming call.
	Press to mute the microphone during an active call and to reactivate it.
	This button keeps the call active. While the call is on hold the listener will not hear the conversation. To reactivate it, press the call accept button  . To reject it, press the reject button  .
	Press to add a participant to the active call.
	Charge status of a mobile telephone connected via "Hands-free profile" (HFP) Bluetooth®.
	Strength of coverage signal received by the mobile telephone.

Enter telephone number menu

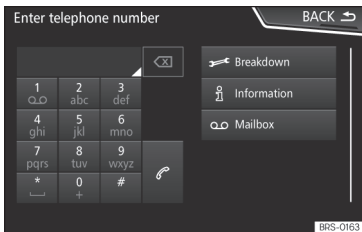

Fig. 190 Enter telephone number menu.

Open the Enter telephone number menu

Press the **DIAL NUMBER** function button from the *PHONE* main menu.

Possible functions

Enter telephone number	Entering a phone number with the keypad. Press the function button to make a call.
Select a contact from the list	Enter the first letters of the contact to find using the keypad. The available entries appear in the phonebook. Select the desired contact from the phonebook to make the call.

Possible functions

Enter the country code	To enter a country code, instead of the first two digits (international access code e.g. "00") you can enter the character "+". Press the function button for approx. 2 seconds to add the +.
Breakdown service call	Press the function button to obtain help in the event of breakdown. The Mobile Service in the network of specialised CUPRA dealers or the network of SEAT dealerships is available for this purpose.
Information call	Press the function button to obtain information on the CUPRA brand and the additional services contracted related to traffic and travel.
Call mailbox	Press the Voicemail function button to make the call. OR: Press the function button for about 2 seconds to make a call. If the number for the mailbox has not yet been stored, enter it and confirm with OK .

Note

- Breakdown service and information calls can incur an additional cost on your telephone bill.

- The Roadside Assistance and Information services might not work properly, for example, if the vehicle and the operator of the connected mobile telephone are in different countries. If you are not able to use these services contact an authorised CUPRA workshop.

Call Menu (call lists)

Possible displays in the Calls menu

Display: Meaning

	Missed calls : Displays the numbers of missed and unanswered calls.
	Dialled numbers : Indicates the numbers dialled on the mobile telephone and on the Infotainment system telephone management system.
	Received calls : Indicates the numbers of the calls received on the mobile telephone and on the Infotainment system telephone management system.

Note

The availability of the call lists will depend on the mobile phone used.

Multimedia

USB/AUX-INPort



Fig. 191 Centre console: USB/AUX-IN input.

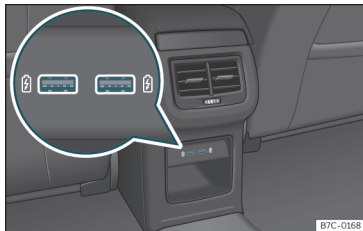

Fig. 192 Centre console, rear section: USB connectors.

Depending on the special characteristics and the country, the vehicle may have a USB/AUX-IN port.

The USB/AUX-IN port can be found in the storage compartment area of the centre console >>> Fig. 191.

The operating description is located in >>> page 184.

Depending on the equipment and the country, the vehicle may also have USB connections **exclusively for charging or as a power socket**.

These USB ports are located at the rear of the console, between the front seats >>> Fig. 192.

Connectivity Box* / Wireless Charger*



Fig. 193 Centre console: slot for mobile phone connection.

The Connectivity Box includes different functions that will help to use your mobile device.

They are the “Wireless Charger” and the “Mobile Signal Amplifier”.

The Wireless Charger only features the “Wireless Charger” function.

“Wireless Charger”

The “Wireless Charger” allows mobile devices with Qi¹⁾ technology to be charged without a cable.

To charge your mobile phone wirelessly:

¹⁾ Qi technology allows you to charge your mobile phone wirelessly.

- Place your mobile device with Qi technology¹⁾ in the middle of the pad with the screen facing up >>> **Fig. 193.**

When you do so, make sure there are no objects between the pad and the mobile phone.

The mobile phone will start charging automatically. For further information about whether your mobile device uses Qi technology, please check your mobile phone's user manual or visit the CUPRA website.

“Mobile Signal Amplifier”

The “*Mobile Signal Amplifier*” allows you to reduce the radiation in your vehicle and enjoy better reception.

For safety reasons, it is recommended that you pair the radio and the mobile device using Bluetooth® and place the mobile phone on the Connectivity Box pad, so as to have better reception without having to handle the mobile phone.

To establish a connection with the vehicle's external aerial:

- Place your mobile device in the middle of the pad with the screen facing up >>> **Fig. 193.**

When you do so, make sure there are no objects between the pad and the mobile phone.

Your mobile phone will automatically be ready to make use of the external aerial.

WARNING

The mobile phone may heat up due to the wireless charging. Think about the temperature of your device before you pick it up, and take care when removing it.

Note

- Your mobile device must support the Qi wireless inductive charging interface standard for proper operation.
- If your mobile phone has a cover or a protective casing, this may affect the Connectivity Box functions.
- There must be no metallic objects between the pad and the mobile device that might affect the wireless charging or the connection with the external aerial.
- The charging time and the temperature vary in accordance with the device used.
- To avoid malfunction, ensure that the mobile phone is correctly placed on the pad.

- The maximum charging capacity is 5 W.
- Qi technology does not allow you to charge more than one mobile device simultaneously.
- No improvement in the transmission quality can be guaranteed if there is more than one mobile phone on the pad.
- You are advised to keep the engine running to guarantee proper wireless charging of your device.
- When a telephone with Qi technology is connected by USB, the charging will be performed through the medium specified by each mobile device manufacturer.

¹⁾ Qi technology allows you to charge your mobile phone wirelessly.

Driving

Start and driving

Starting and stopping the engine

Starter button

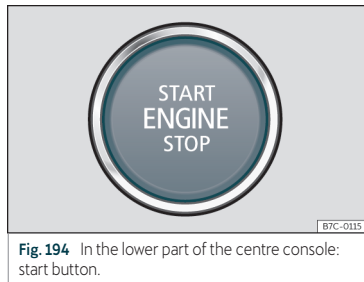

Fig. 194 In the lower part of the centre console: start button.



Fig. 195 On the right of the steering column: emergency start.

Read the additional information carefully

»» page 30

The vehicle engine is started with a starter button (Press & Drive). To do so, there must be a valid key inside the vehicle in the area of the front or rear seats.

In vehicles with the Keyless Access »» page 112 system, the engine can also be started with the key in the luggage compartment.

Opening the driver's door **when exiting the vehicle** activates the electronic lock on the steering column if the ignition is disabled.

Switching the ignition on/off manually

Briefly push the starter button without touching the brake »» .

The starter button text **START ENGINE STOP** flashes like a heartbeat when the system is preset for switching the ignition on and off.

Automatic ignition switch-off

If the driver leaves the vehicle, taking the vehicle key with them but leaving the ignition on, the ignition is not switched off automatically. The ignition is switched off automatically by pressing the lock button on the remote control or manually by pressing the sensor surface on the door lever »» **Fig. 110**

Emergency starting function

If no valid key is detected inside the vehicle, an emergency start-up will be required. The relevant message will appear in the dash panel display. This may happen when, for example, the battery of the vehicle key button is very low or flat:

- Immediately after pushing the starter button, keep the vehicle key next to the right trim of the steering column »» **Fig. 195**, as close as possible to the Kessy logo.
- The ignition connects and the engine starts automatically.

Emergency disconnection

If the engine does not switch off after briefly pressing the starter button, an emergency disconnect will be required:

- Press the starter button twice within 3 seconds or press it once for more than 1 second >>> .
- The engine turns off automatically.

Engine restart feature

If no valid key is detected inside the vehicle after the engine stops, you will only have 5 seconds to restart it. A warning will display on the dash panel screen.

After this interval, it will not be possible to start the engine without a valid key inside the vehicle.

Automatic deactivation of the ignition on vehicles with the Start-Stop system

The ignition is switched off automatically when the vehicle is stopped and the automatic engine shutdown is active, if:

- The driver's seat belt is not fastened,
- the driver does not step on any pedal,
- the driver door is opened.

After automatically turning off the ignition, if the dipped beam  is on, the side light remains on for approx. 30 minutes (if the battery has enough charge). If the driver locks the vehicle or manually turns off the light, the side light goes out.

Instructions for the driver on the instrument panel display

Press the brake

This message appears on vehicles with an automatic gearbox if the driver tries to start the engine without having the brake pedal pressed.

Select N or P

This message appears if you try to start or stop the engine when the selector lever of the automatic gearbox is not in position **P** or **N**. The engine can only be started and stopped in those positions.

Engage position P; the vehicle can move; doors can only close in position P.

For safety reasons, this driver message appears and an audible warning sounds if the selector lever of the automatic gearbox is not in position **P** after you switch off the ignition. Move the selector lever to the **P** position, otherwise the vehicle could roll away.

Gear change: selector lever in the drive position!

This driver message is displayed when the selector lever is not in the position **P** when the driver door is opened. Additionally, a buzzing sound is emitted. Put the selector lever in position **P**, otherwise the vehicle could roll away.

Ignition is switched on

This driver message is displayed and a buzzer is sounded when the driver door is opened with the ignition switched on.

WARNING

Any accidental movement of the vehicle could result in serious injury.

- When switching on the ignition, *do not* press the brake or clutch pedal, otherwise the engine could start immediately.

WARNING

If vehicle keys are used negligently or without due care, this may cause accidents and serious injury.

- Never leave any key inside the vehicle when exiting. Otherwise, a child or unauthorised person could lock the vehicle, start the engine or connect the ignition and, in this way, operate electronic equipment (e.g. the windows).

Note

- Before leaving the vehicle, always disconnect the ignition manually and, if appropriate, take into account the instructions on the screen of the dash panel.
- If the vehicle is stationary for a long time with the ignition on, the vehicle battery might be discharged and it might not be possible to start the engine.

»

- If during the STOP phase you press the **(START ENGINE STOP)** button, the ignition is switched off and the button flashes.
- If the indication is displayed on the instrument panel display “Start-Stop system deactivated: Start the engine manually”, the **(START ENGINE STOP)** button will blink.

Starting the engine

Step	Starting the engine with the starter button >>> page 214 (Press & Drive).
1.	Press and hold the brake pedal until step 5 is performed.
2.	Move the selector lever to the P or N position.
3.	Briefly press the starter button >>> Fig. 194 without pressing the accelerator. For the engine to start there must be a valid key in the vehicle. After starting the engine, the light of the (START ENGINE STOP) button changes to a fixed light indicating that the engine has started.
4.	If the engine does not start, stop and wait for approx. 1 minute before trying again. If necessary, carry out an emergency start >>> page 214.
5.	Disconnect the electronic parking brake when you are about to start driving >>> page 217.

⚠ WARNING

- Never run the engine in confined spaces, as the exhaust gases are poisonous.
- Never leave the vehicle with the engine running, especially if a gear or gear range is engaged. The vehicle could then suddenly move or something strange could happen that would cause damage, fire or serious injury.

⚠ WARNING

- Cold start sprays could explode or cause a sudden increase in the engine speed.
- Never use sprays to cold start the engine.

ⓘ CAUTION

- The starter motor or the engine may be damaged if you try to start the engine while driving or if you restart it immediately after switching it off.
- If the engine is cold, avoid high engine speeds, pushing the engine too hard and rapid acceleration.
- Do not start the engine by pushing the vehicle or towing it. Unburnt fuel could enter the catalytic converter and damage it.

ⓘ Note

- Do not wait until the engine warms up with the vehicle stationary; if you have good visibility through the windows, start

driving immediately. This helps the engine reach operating temperature faster and reduces emissions.

- Electrical components with a high power consumption are switched off temporarily when the engine starts.
- When starting with a cold engine, noise levels may briefly increase. This is quite normal, and no cause for concern.
- When the outside temperature is below +5 °C (+41 °F), if the engine is diesel, some smoke may appear under the vehicle when the fuel-operated auxiliary heater is on.

Stopping the engine

Step	Switch off the engine with the starter button >>> page 214.
1.	Stop the vehicle completely >>> ⚠.
2.	Press and hold the brake pedal until the step 4 is performed.
3.	Move the selector lever to the P position.
4.	Connect the electronic parking brake >>> page 217.
5.	Briefly press the start-up button >>> Fig. 194. The (START ENGINE STOP) button blinks again. If the engine fails to switch off, perform an emergency disconnect >>> page 214.

⚠ WARNING

Never switch off the engine while the vehicle is moving. This could cause loss of control of the vehicle, accidents and serious injury.

- The airbags and belt tensioners do not work when the ignition is switched off.
- The brake servo does not work with the engine off. Therefore, you need to press the brake pedal harder to brake the vehicle.
- Power steering does not work when the engine is not running. You need more strength to steer when the engine is switched off.
- If the ignition is switched off, the steering column could be locked, making it impossible to control the vehicle.

ⓘ CAUTION

If the engine is made to work hard for a long time, it may overheat after being switched off. To prevent damage to the engine before switching it off, leave it idle for approx. 2 minutes in neutral.

“My Beat” Function

For vehicles with a convenience key there is the “My Beat” function. This feature provides an additional indication of the vehicle ignition system.

When accessing the vehicle, e.g. by opening the doors with the remote control, the **(START ENGINE STOP)** button flashes, calling attention to the relevant starter system button.

Upon switching the ignition on/off, the light of the **(START ENGINE STOP)** button flashes. With the engine switched off, after a few seconds, the **(STOP ENGINE START)** button stops flashing and goes out.

With the engine running, the **(START ENGINE STOP)** button light stays on, indicating that the engine is running. The time that lapses between the moment the user starts the engine with the **(START ENGINE STOP)** button and the lighting changes from flashing to fixed will depend on specific engine size characteristics. Upon switching the ignition off with the **(START ENGINE STOP)** button, it starts flashing again.

In vehicles with the **Start-Stop system**, the “My Beat” function also offers additional information:

- When the engine stops during the Stop phase, the light of the **(START ENGINE STOP)** button stays on, since, even though the engine is off, the Start-Stop system is active.
- When the engine cannot be started again with the Start-Stop system, >>> page 238, and needs to be started manually, the **(START ENGINE STOP)** button flashes to indicate this fact.

Braking and parking**Information on the brakes****New brake pads**

For the first 400 km (250 miles), new brake pads have not yet reached their maximum braking capacity, and need to be “run in” first. However, you can compensate for the slightly reduced braking effect by applying more pressure on the brake pedal. Avoid overloading the brakes while running them in.

Wear

The rate of wear on the **brake pads** depends a great deal on how you drive and the conditions in which the vehicle is operated. This is a particular problem in urban traffic and short stretches, or with very sporty driving.

Depending on the speed, the braking force and the environmental conditions (for example, the temperature, air humidity, etc.) noises may be produced on braking.

Wet roads or road salt

In certain situations (for example, on driving through flooded areas, in severe downpours or after washing the vehicle) the braking action could be delayed if the discs and pads are damp, or frozen in winter. In this case the »

brakes should be “dried” by pressing the brake pedal several times.

At high speed and with the windscreen wipers activated, the brake pads will briefly touch the brake discs. This takes place, although unnoticeable to the driver, at regular intervals to improve the response time of the brakes when they are wet.

The effectiveness of the brakes can also be temporarily reduced if the vehicle is driven for some distance without using the brakes when there is a lot of salt on the road in winter. The layer of salt that accumulates on the discs and pads can be removed by gently applying the brakes a few times.

Corrosion

There may be a tendency for corrosion to form on the discs and dirt to build up on the brake pads if the vehicle is used infrequently or the brakes are not used very often.

If the brakes are not used frequently, or if rust has formed on the disks, it is advisable to clean off the pads and disks by braking firmly a few times at a moderately high speed >>> △.

Fault in the brake system

If the brake pedal travel should ever increase *suddenly*, this may mean that one of the two brake circuits has failed. Drive immediately to the nearest specialised workshop and have the fault repaired. Drive there slowly and re-

member that you will have to apply more pressure on the brake pedal and allow for longer stopping distances.

Low brake fluid level

Malfunctions can occur in the brake system if the brake fluid level is too low. The brake fluid level is monitored electronically.

Brake servo

The brake servo increases the pressure you apply to the brake pedal. It works only when the engine is running.

⚠ WARNING

- Apply the brakes heavily to clean the brake system only in a suitable traffic situation. Do not put other road users in danger: there is risk of causing an accident.
- Ensure the vehicle does not move while in neutral, when the engine is stopped. Failure to follow this instruction could result in an accident.
- If the brake fluid loses its viscosity and is subjected to heavy use, vapour bubbles can form in the brake system. This reduces the efficiency of the brakes.

ⓘ CAUTION

- Never let the brakes “drag” by leaving your foot on the pedal when it is not necessary to brake. This overheats the brakes, re-

sulting in longer stopping distances and greater wear.

- Before driving down a long, steep gradient, it is advisable to reduce speed and select a lower gear. This makes use of engine braking and relieves the brakes. If you still have to use the brakes, it is better to brake firmly at intervals than to apply the brakes continuously.

ⓘ Note

- If the brake servo is out of action, for example when the car is being towed, you will have to press the brake pedal considerably harder than normal to make up for the lack of servo assistance.
- If you wish to equip the vehicle with accessories such as a front spoiler or wheel covers, it is important that the flow of air to the front wheels is not obstructed, otherwise the brakes can overheat.

Control lamps

🔴 It lights up red

Brake fluid level too low >>> page 317 or fault in the brake system.

🚫 Do not carry on driving!

It lights up red

Electronic parking brake >>> page 219.
The warning lamp turns off when the electronic parking brake is released.



It lights up green

Auto Hold function activated >>> page 241.

It lights up yellow

Front brake pads worn.

WARNING

- If the brake warning lamp does not go out or if it lights up when driving, the brake fluid level in the reservoir is too low so there is a risk of an accident >>> page 317, Brake fluid. Stop the vehicle and do not drive on. Obtain technical assistance.
- If the brake warning lamp lights up  together with the ABS lamp  this could be due to an ABS fault. This could cause the rear wheels to lock quickly when you brake. This could cause the rear to break away. Risk of skidding. Stop the vehicle and seek technical assistance.

Electronic parking brake





Fig. 196 Centre console, lower part: electronic parking brake button.



The electronic parking brake replaces the handbrake.

Activating the electronic parking brake

The electronic parking brake can be activated whenever the vehicle is at a standstill, even when the ignition is switched off. Activate it whenever you leave or park the vehicle.

- Pull and hold the  >>> Fig. 196 button.
- The parking brake is activated when the control light of the >>> Fig. 196 button (arrow) and the red  control light of the display in the dash panel are on.
- Release the button.

Releasing the electronic parking brake

- Switch the ignition on.
- Press the button  >>> Fig. 196. At the same time step hard on the brake pedal or, if the engine is running, press the accelerator pedal slightly.
- The control light of the >>> Fig. 196 button (arrow) and the red  control light of the display in the dash panel go out.

Automatic release of the electronic parking brake on starting the engine

The electronic parking brake is automatically switched off when starting if, after the driver's door is closed and the driver's seat belt fastened, **any** of the following situations take place:

- A gear range is engaged or switched to another one and the accelerator pedal is lightly pressed.
- To facilitate certain manoeuvres there are exceptions that allow the automatic parking brake to be released without the driver's seat belt being fastened.

The parking brake can be prevented from being automatically released by continuously pulling up the  >>> Fig. 196 switch when starting off.

The electronic parking brake is not disconnected until the  button is released. This >>>

can facilitate starting off when a heavy load is towed >>> page 296.



Automatic activation of the electronic parking brake when exiting the vehicle incorrectly

In vehicles with automatic transmission, the electronic parking brake is activated automatically when exiting the vehicle incorrectly if:

- The selector lever is in the **D/S** or **R** position or in the Tiptronic selector gate.
- **AND:** the vehicle is stationary.
- **AND:** the driver door is open.

Emergency braking function

Only use the emergency brake function if you are unable to stop the vehicle with the foot brake >>> .

- Pull and hold the  >>> **Fig. 196** button in this position to **forcefully** stop the vehicle. At the same time, an acoustic warning can be heard.
- To stop the braking process, release the  button or press the accelerator.

WARNING

The improper use of the electronic parking brake can cause accidents and serious injury.

- Never use the electronic parking brake to stop the vehicle, unless it is an emergency. Braking distances can be considerably longer, since, under certain circumstances, only the rear wheels brake. Always use the foot brake.

- Never accelerate from the engine when a gear range or a gear is engaged and the engine is running. The vehicle could move, even if the electronic parking brake is activated.

CAUTION

To prevent the vehicle from unintentionally moving when parking it, first apply the electronic parking brake and then remove your foot from the brake pedal.

Note

- If the vehicle battery is flat, it will not be possible to disconnect the electronic parking brake. Use the jump-start >>>  page 52.
- When the electronic parking brake is applied or released, noises may be heard.
- The system performs automatic and audible tests sporadically in the parked vehicle if some time elapses without the electronic parking brake being used.

Parking

The electronic parking brake should always be applied when the vehicle is parked.

Always note the following points when parking the vehicle:

- Use the brake pedal to stop the vehicle.
- Apply the electronic parking brake.
- Put it in 1st gear.
- Switch the engine off and remove the key from the ignition. Turn the steering wheel slightly to engage the steering lock.
- Never leave a vehicle key in the vehicle.

Additional notes on parking the vehicle on gradients:

Turn the steering wheel so that the vehicle rolls against the kerb if it started to roll.

- If the vehicle is parked facing **downhill**, turn the front wheels so that they point *towards the kerb*.
- If the vehicle is parked facing **uphill**, turn the front wheels so that they point *away from the kerb*.
- Secure the vehicle as usual by applying the electronic parking brake firmly and putting it in 1st gear.

⚠ WARNING

- Take measures to reduce the risk of injury when you leave your vehicle unattended.
- Never park where the hot exhaust system could ignite inflammable materials, such as dry grass, low bushes, spilt fuel etc.
- Never allow vehicle occupants to remain in the vehicle when it is locked. They would be unable to open the vehicle from the inside, and could become trapped in the vehicle in an emergency. In the event of an emergency, locked doors will delay assistance to vehicle occupants.
- Never leave children alone in the vehicle. They could set the vehicle in motion, for example, by releasing the electronic parking brake or the gearshift lever, which would cause the vehicle to move, but uncontrollably.
- Depending on weather conditions, it may become extremely hot or cold inside the vehicle. This can be fatal.

Braking and stability systems**Control lamps** **It lights up**

Fault in the ESC or disconnection caused by the system.
As the ESC operates in conjunction with the ABS, the ESC light will also come on if a fault should occur in the ABS.

 **Flashes**

ESC or ASR activated.

 **It lights up**

ESC in Sport mode.

Or: ESC deactivated »» page 223.

 **It lights up**

ABS faulty or does not work.

The control lamps light up together when the ignition is switched on and should turn off after approximately 2 seconds. This is the time taken for the function check.

Hydraulic Brake Assist (HBA)**Electronic Stability Control (ESC)**

The ESC helps to improve safety. It reduces the tendency to skid and improves the stability and roadholding of the vehicle. The ESC detects critical handling situations, such as vehicle understeer or oversteer, or wheel-spin on the driving wheels. It stabilises the vehicle by braking individual wheels or by reducing the engine torque. The warning lamp will flash on the instrument panel when the ESC is intervening .

The ESC includes the anti-lock brake system (ABS), the hydraulic brake assist (HBA), the traction control system (ASR), electronic differential lock (EDS), electronic torque control (XDS) and tractor-trailer sway mitigation*. ESC also helps stabilise the vehicle by changing the torque.

Anti-lock brake system (ABS)

ABS prevents the wheels from locking up under braking until the vehicle has reached a virtual standstill. You can continue to steer the vehicle even when the brakes are on full. Keep your foot on the brake pedal and do not pump the brakes. You will feel the brake pedal pulsate while the ABS is working. »

Hydraulic Brake Assist (HBA)

The brake assist system can reduce the required braking distance. The braking force is automatically boosted if you press the brake pedal quickly in an emergency. You must keep pressing the brake pedal until the danger has passed.

Traction control system (ASR)

In the event of wheelspin, the traction control system reduces the engine torque to match the amount of grip available. This helps the car to start moving, accelerate or climb a gradient.

Electronic differential lock (EDL)

When the EDL detects wheelspin, it brakes the spinning wheel and directs the power to the other driven wheel. This function is active up to approximately 100 km/h (62 mph).

To prevent the disc brake of the braked wheel from overheating, the EDL cuts out automatically if subjected to excessive loads. The vehicle can still be driven. The EDL will switch on again automatically when the brake has cooled down.

Tractor-trailer sway mitigation*

If the vehicle is pulling a trailer, it will control the following: tractor-trailers tend to sway. When the swaying of the trailer is felt by the vehicle and detected by the ESC, it will auto-

matically brake the towing vehicle within the limits of the system and mitigate the sway. Tractor-trailer sway mitigation is not available in all countries.

Electronic torque management (XDS)

When taking a curve, the driveshaft differential mechanism allows the outer wheel to turn at a higher speed than the inner wheel. In this way, the wheel that is turning faster (outer wheel) receives less drive torque than the inner wheel. This may mean that in certain situations the torque delivered to the inner wheel is too high, causing the wheels to spin. On the other hand, the outer wheel is receiving a lower drive torque than it could transmit. This causes an overall loss of lateral grip on the front axle, resulting in understeer or “lengthening” of the trajectory.

The XDS system can detect and correct this effect via the sensors and signals of the ESC.

Via the ESC, the XDS will brake the inside wheel and counter the excess driving torque of that wheel. This means that the driver's desired trajectory is much more precise.

The XDS system works in combination with the ESC and is always active, even when ASR traction control is disconnected, or the ESC in Sport mode or disconnected.

Multi-collision Brake

In an accident, the multi-collision brake can help the driver by braking to avoid the risk of skidding during the accident, which could lead to further collisions.

The multi-collision brake works for front, side or rear accidents, when the airbag control unit records its activation level and the accident takes place at a speed of over 10 km/h (6 mph). The ESC automatically brakes the vehicle, as long as the accident has not damaged the ESC, the brake hydraulics or the on-board network

The following actions control automatic braking during the accident:

- When the driver presses the accelerator, the automatic braking does not take place.
- When the braking pressure through pressing the brake pedal is greater than the system's braking pressure the vehicle will brake automatically.
- Multi-collision braking will not be available if ESC is malfunctioning.



WARNING

- The ESC, ABS, ASR, EDS and the electronic torque control system cannot exceed the limits imposed by the laws of physics. Always bear this in mind, especially on wet or slippery roads. If you notice the systems cutting in, you should reduce your speed

immediately to suit the road and traffic conditions. Do not be encouraged to take risks by the presence of more safety systems. If you do, an accident may occur.

- Please remember that the accident risk always increases if you drive fast, especially in corners or on a slippery road, or if you follow too close behind the vehicle in front of you. The ESC, ABS, brake assist, EDS and the electronic torque control system cannot prevent accidents: risk of accidents!
- Accelerate with caution on slippery surfaces (for example, icy or snow-covered). Despite the control systems, the driven wheels could spin, affecting the stability of the vehicle: risk of accident!

Note

- The ABS and ASR will only operate correctly if the four wheels have identical tyres. Any differences in the rolling radius of the tyres can cause the system to reduce engine power when this is not desired.
- The regulating processes of the systems can make noises when they intervene.
- If the warning lamp  lights up, or  alternatively, there could be a fault >>> page 109.

Connecting/disconnecting the ESC

The ESC is switched on automatically when the engine is started, and only works when the engine is running and includes the ABS, EDS and ASR systems.



ESC in "Sport" mode

Sport mode can be connected via the Easy Connect >>>  page 33 system menu. ESC is restricted and the ASR is completely deactivated.

The control lamp  lights up. For vehicles with a driver information system* the driver will be informed that:

Electronic Stability Control (ESC): sport. Warning! Limited stability

Disable ESC "Sport" mode

Through the Easy Connect system menu >>>  page 33. The warning lamp  will switch off. For vehicles with a driver information system* the driver will be informed that:

Electronic Stability Control (ESC): on

Disconnection of the ESC

In some versions of the model, besides the traction control system (ASR), the electronic stability programme (ESC) can also be switched off.

- Deactivate the ESC function in the Easy Connect system using the  button and the **SETTINGS > ESC System** function button.

The electronic stability control (ESC) is disconnected, as well as the ASR function. The  control lamp lights up and the **ESC OFF** message is displayed permanently on the instrument panel display.

Connecting the ESC

- Activate the ESC function in the Easy Connect system using the  button and the **SETTINGS > ESC System** function button.

The  control lamp and the **ESC OFF** message on the instrument panel switch off.

ESC in "Offroad" mode¹⁾

Turn the Driving Experience button to select the Offroad mode and connect it >>> page 272. The interventions of the ESC, as well as of the ASR, EDS and the ABS, adapt to irregular terrain. »

¹⁾ Only for 4Drive models.

In the following exceptional situations it may make sense to activate the Offroad mode to allow the wheels to spin:

- When “swinging” the vehicle to get it unstuck.
- Driving in deep snow or on loose surfaces.
- When driving on rough terrain with much of the car’s weight is lifted off the wheels (axle articulation).
- Steep descents with braking on unpaved terrain.

For your safety we recommend that you turn off the Offroad mode when it is not absolutely necessary.

Disable the ESC Offroad mode

Turn the Driving Experience button to select a different driving mode >>> page 272.

ESC in “Snow” mode¹⁾

Turn the Driving Experience button to select the “Snow” mode and connect it. >>> page 272 Traction control system (ASR) interventions adjust to the adhesion of snowy roads.

Disable the ESC “Snow” mode

Turn the Driving Experience button to select a different driving mode >>> page 272.

WARNING

You should switch on the ESC Sport mode only if the traffic conditions and your driving ability allow you to do so safely: risk of skidding!

- With ESC in Sport mode, the stabilising function will be limited to allow for a sportier drive. The driving wheels could spin and the vehicle could “skid”.
- If the ESC is deactivated, the vehicle stabilisation function is not available.

WARNING

You should only activate the Offroad Mode or disable the ASR if the experience of the driver and traffic conditions allow it. Danger of skidding!

- With the Offroad mode activated, the stabilisation function is limited. In particular, if the road is too smooth and slippery, the driving wheels could spin and the vehicle could skid.

Note

- If the ESC Sport mode is selected, cruise control* will be switched off.
- In ESC OFF mode, the ESC will be temporarily reactivated to assist the driver during braking and will then switch back to passive mode when the brake pedal is released (depending on the model version).

DSG automatic gearbox

Introduction

Your vehicle is equipped with an electronically controlled manual gearbox. Torque between the engine and the gearbox is transmitted via two independent clutches. They replace the torque converter found on conventional automatic gearboxes and allow for smooth, uninterrupted acceleration of the vehicle.

The **tiptronic** system allows the driver to change gears *manually* if desired >>> page 227, Engaging gears with the tiptronic mode.

¹⁾ Only for 4Drive models.

Control lamps

It lights up green

The brake pedal is not engaged.
To select a range of gears, press the brake pedal.

Flashes green

The interlock button on the selector lever is not pressed.
Movement of the vehicle is prevented. Engage the selector lever lock.

Selector lever positions

Read the additional information carefully
 page 38

The selector lever position engaged is highlighted on the display in the instrument cluster. With the selector lever in the manual gearbox positions G, D, E and S, the engaged gear is also indicated on the display.

P – Parking lock

When the selector lever is in this position, the driven wheels are locked mechanically. The parking lock must be engaged only when the vehicle is *stationary* >>> .

The interlock button (the button on the selector lever handle) must be pressed *and* simultaneously the brake pedal must be de-

pressed before moving the selector lever either in or out of position P.

R – Reverse gear

Reverse gear must be engaged only when the vehicle is *stationary* and the engine is idling >>> .

To move the selector lever to position R, the interlock button must be pressed in *and* at the same time the brake pedal must be depressed. The reverse lights come on when the selector lever is in the R position with the ignition on.

N – Neutral (idling)

With the selector lever in this position, the gear is in neutral.

D/S – Permanent drive (forward) position

The selector lever in the D/S position enables the gears to be controlled in normal mode (D) or Sport (S). To select Sport mode (S), move the selector lever backwards. Moving the lever again will select normal mode (D). The selected driving mode is shown on the instrument panel display.

In **normal mode** (D), the gearbox automatically selects the best gear ratio. This depends on the engine load, the road speed and the dynamic gear control programme (DCP).

Sport mode (S) must be selected for a sporty driving style. This setting makes use of the engine's maximum power output. When accelerating the gear shifts will be noticeable.

Press the brake pedal to move the selector lever from N to D/S when the vehicle is stationary or at speeds below 3 km/h (2 mph) >>> .

Under certain circumstances (e.g. when driving in mountains) it can be advantageous to switch temporarily to tiptronic mode >>> page 227, in order to *manually select* gear ratios to suit the driving conditions.

WARNING

- Take care not to accidentally press the accelerator pedal when the vehicle is stopped. The vehicle could otherwise start moving immediately (in some cases even if the parking brake is engaged) resulting in the risk of an accident.
- Never move the selector lever to R or P when driving. Failure to follow this instruction could result in an accident.
- With selector lever in any position (except P) the vehicle must always be held with the foot brake when the engine is running. This is because an automatic gearbox still transmits power even at idling speed, and the vehicle tends to “creep”. The accelerator pedal must on no account be pressed inadvertently when a gear is engaged with the vehicle stationary. The

»

vehicle could otherwise start moving immediately (in some cases even if the parking brake is engaged) resulting in the risk of an accident.

- While you are selecting a gear and the vehicle is stopped with the engine running, do not accelerate. Failure to follow this instruction could result in an accident.
- As a driver you should never leave your vehicle if the engine is running and a gear is engaged. If you have to leave your vehicle while the engine is running, you must apply the handbrake and engage the parking lock (P).
- To avoid accidents, apply the handbrake and put the selector lever in position P before opening the bonnet and working on the vehicle with the engine running. Please always observe the important safety warnings >>> page 310, Working in the engine compartment.

Note

- If the selector lever is moved accidentally to N when driving, release the accelerator and let the engine speed drop to idling before selecting gear range D or S again.
- Should the power supply to the selector lever be interrupted in position P, the selector lever will be locked. If this should happen the manual release can be used >>>  page 38.

Selector lever lock

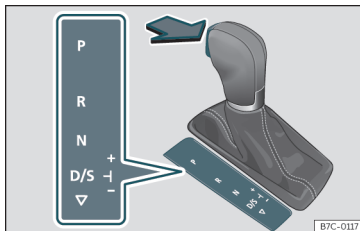

Fig. 197 Selector lever lock.

The selector lever lock prevents gears from being engaged inadvertently, so that the vehicle is not set in motion unintentionally.

The selector lever lock is released as follows:

- Switch the ignition on.
- Press the brake pedal *and*, at the same time, hold the lock button in the direction of the arrow >>> **Fig. 197**.

Automatic selector lever lock

With the ignition switched on, the selector lever is locked in the positions P and N. The brake pedal must be pressed to release the lever while pressing the release button if the selector lever is in the position P. As a reminder for the driver, with the lever in positions P or N the following message will be shown on the display:

When stationary, apply footbrake while selecting a gear.

Level lock only engages with the vehicle stationary and at speeds of up to 5 km/h (3 mph). At speeds of over 5 km/h (3 mph) the lever lock is automatically deactivated in position N.

The selector lever lock is not engaged if the selector lever is moved quickly through position N (e.g. when shifting from R to D). This makes it possible, for instance, to rock the vehicle “backwards and forwards” if it is stuck. The selector lever lock engages automatically if the brake pedal is not depressed and the lever is in position N for more than about two seconds.

Interlock button

The interlock button on the selector lever handle prevents the driver from inadvertently engaging certain gears. Press the button in to disengage the selector lever lock.

Note

- If the selector lever lock does not engage, there is a fault. The transmission is interrupted to prevent the vehicle from accidentally moving. To lock the selector lever again, press the brake pedal, place the selector lever in the P or N position and then engage a gear.

- Despite a gear being engaged, the vehicle does not move forwards or back. Proceed to the next mode:

- When the vehicle does not move in the required direction, the system may not have the gear range correctly engaged. Press the brake pedal and engage the gear range again.
- If the vehicle still does not move in the required direction, there is a system malfunction. Seek specialist assistance and have the system checked.

Engaging gears with the tiptronic mode

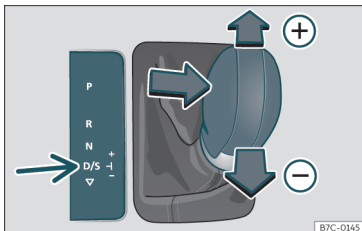

Fig. 198 Centre console: changing gear with tiptronic

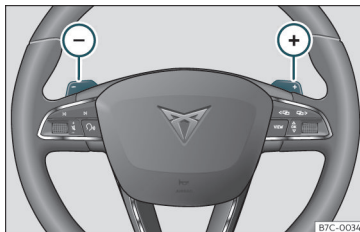

Fig. 199 Steering wheel: automatic gearbox levers

The tiptronic gives the driver the option to change gears manually.

Changing gear manually with the selector lever

It is possible to change to tiptronic mode, both when the vehicle is stopped and while driving.

- To switch to tiptronic mode, move the selector lever from position D/S to the right. As soon as the change is made the selector level will be shown in the position **M** on the instrument panel display (for example **M4** means that the fourth gear is engaged).
- Move the selector lever forwards (+) to select a higher gear >>> **Fig. 198**.
- Move the selector lever backwards (-) to select a lower gear.

Changing gear manually with the gearshift paddles

The gearshift paddles can be used when the selector lever is in the position D/S or M.

- Press the gearshift paddle (+) to select a higher gear >>> **Fig. 199**.
- Press the gearshift paddle (-) to select a lower gear.
- With the selector lever in position D/S, if no paddle is operated during a short period of time, the gearbox control system switches back to automatic mode. To switch to permanent manual gear change using the gearshift paddles, move the selector lever from position D/S to the right.

When accelerating, the gearbox automatically shifts up into the next gear shortly before the maximum engine speed is reached.

If you select a lower gear, the automatic gearbox will not shift down until there is no risk of over-revving the engine.

When the kick-down feature is used, the gearbox shifts down to a lower gear, depending on road speed and engine speed.

Gear recommendation

A gear change will be recommended if the gear you are in is not the most economical choice. If no gear-change is recommended, »

it means that you are already in the most economical gear.

The display is only visible in tiptronic mode »» page 227.

The following display symbols mean:

- ↑ Shifting up a gear
- ↓ Shifting down a gear

ⓘ CAUTION

The gear-change indicator is intended to help save fuel, but it is not intended to recommend the right gear for all driving situations. In certain situations, only the driver can choose the correct gear (for instance when overtaking, driving up a steep gradient or towing a trailer).

Driving tips

The gearbox changes gear ratios automatically as the vehicle moves.

The engine can only start with the selector lever in position P or N. At low temperatures, below -10 °C (+14 °F), the engine can only start with the selector lever in position P.

Starting the vehicle

- Press and hold the brake pedal.

- Press and hold the interlock button (the button on the selector lever handle), move the selector lever to the desired position, for instance **D** »» page 225, and release the interlock button.

- Wait for the gearbox to engage the gear (a slight movement can be felt).

- Release the brake and press the accelerator »» ⚠.

Stopping briefly

- Apply the foot brake to hold the vehicle briefly when stationary (for instance at traffic lights). Do not press the accelerator.

Stopping/Parking

If the driver door is opened and the selector lever is not in position P, the vehicle could move. The driver message will be: ⚠ **Gear change: selector lever in the drive position!** . Additionally, a buzzer will sound.

- Press and hold the brake pedal »» ⚠.

- Apply the handbrake.

- Move the selector lever to position P.

Holding the car on a hill

- *Always* apply the brake pedal firmly to prevent the vehicle from “moving backwards; if necessary, apply the handbrake” »» ⚠.

Do **not** try to stop the vehicle “rolling back” by increasing the engine speed when a gear is engaged (pressing the accelerator) »» ⓘ.

Driving downhill: in some situations (on mountain roads or when towing a trailer or caravan) it can be advantageous to switch temporarily to the manual gearbox programme so that the gear ratios can be selected manually to suit the driving conditions »» ⚠.

On level ground it is sufficient to move the selector lever to position P. On slopes, first engage the parking brake and then put the selection lever into the P position. This avoids overloading the locking mechanism and it will be easier to move the selector lever from position P.

⚠ WARNING

Observe the safety warnings »» ⚠ in Selector lever positions on page 225.

- **Never allow the brake to rub and do not use the brake pedal too often or for long periods. Constant braking causes overheating in the brakes. This could significantly reduce braking power, increase braking distance or even result in the total failure of the brake system.**
- **To avoid rolling back on gradients always hold the vehicle with the footbrake or handbrake if you have to stop.**

ⓘ CAUTION

- If you stop the vehicle on a gradient, do not attempt to stop it from rolling by depressing the accelerator when a gear has been selected. This could cause overheating and damage the automatic gearbox. Apply the handbrake firmly or press the brake pedal in order to prevent the vehicle from rolling back.
- If you allow the car to roll with the selector lever in position N with the engine switched off, the automatic gearbox will be damaged as it will not be lubricated.
- In certain driving situations or traffic conditions, such as frequently starting, prolonged “creeping” of the vehicle or traffic jams with continuous stoppages, the gearbox could overheat causing damage! If the warning lamp  lights up, stop the vehicle as soon as possible and wait for the gearbox to cool >>> page 230.

Kick-down feature

The kick-down feature allows maximum acceleration to be reached.

¹⁾ Vehicles without driver information system: the warning lamp flashes slowly/Vehicles with driver information system: the warning lamp stays on.

When the accelerator pedal is pressed right down past the point of resistance at full throttle, the gearbox will shift down to a lower gear, depending on road speed and engine speed. The upshift to the next higher gear is delayed until the engine reaches maximum rpm.

⚠ WARNING

Please note that if the road surface is slippery or wet, the kick-down feature could cause the driving wheels to spin, which could result in skidding.



Launch control program

✓ Valid for vehicles: with Launch-Control/6-Speed DSG with petrol engines superior to 140 kW.

The Launch control programme enables maximum acceleration.

Condition: the engine must have reached operating temperature and the steering wheel must not be turned.

The engine speed for launch-control is different on petrol and diesel engines. To use

the launch-control you must disconnect the anti-slip regulation (ASR) through the Easy Connect system menu >>>  page 33. The warning lamp  will stay switched on or will flash slowly depending on whether or not the vehicle has a driver information system*.

On vehicles with the driver information system, the ESC lamp lights up permanently and the corresponding text message **Stability control deactivated** (temporary) appears on the instrument panel to indicate the deactivation status.

- When the engine is running, switch off the traction control (ASR)¹⁾.
- Turn the selector lever to the “S” or tip-tronic position, or else select the **sport** driving mode from the Drive Profile* >>> page 271.
- Press the brake pedal firmly with your left foot and hold it down for at least one second.
- With your right foot, press the accelerator down to the full throttle or kick-down position. The engine speed will stabilise at about **3,200 rpm** (petrol engine) or about **2,000 rpm** (diesel engine). »

- Take your left foot off the brake pedal.

WARNING

- Always adapt your driving style to the traffic conditions.
- Only use the launch control programme when road and traffic conditions permit, and make sure your manner of driving and accelerating the vehicle does not inconvenience or endanger other road users.
- Make sure that the ESC remains switched on. Please note that when the ASR and ESC are deactivated, the wheels may start to spin, causing the vehicle to lose grip. Risk of accident!
- After putting the vehicle into gear, the “sport” mode of the ESC should be deactivated again by briefly pressing the  button.

Note

- After using the Launch control programme, the temperature in the gearbox may have increased considerably. In this case, the programme could be disabled for several minutes. The programme can be used again after the cooling phase.
- Accelerating with the Launch control programme places a heavy load on all parts of the vehicle. This can result in increased wear and tear.

Downhill speed control*

The downhill speed control function helps the driver when driving down steep gradients.

Downhill speed control is activated when the selector lever is in D/S and the driver applies the foot brake. The automatic gearbox automatically engages a lower gear that is suitable for the slope. The downhill speed control function attempts to maintain the speed at which the vehicle was travelling when the foot brake was applied (subject to the laws of physics and technical drive limitations). It may be necessary to adjust the speed again using the foot brake in certain situations. Given that the downhill speed control can only change down to 3rd gear, on very steep descents the tiptronic mode may be required. In this case, manually reduce the tiptronic to 2nd or 1st gear to use the engine brake and reduce the charge on the brakes.

Downhill speed control is deactivated as soon as the road levels out again or you press the accelerator pedal.

On vehicles with cruise control system* >>> page 242, downhill speed control is activated when you set a cruising speed.

WARNING

The downhill speed control cannot defy the laws of physics. Therefore, speed cannot be

maintained constant in all situations. Always be prepared to use the brakes!

Emergency program

A backup programme is in place if a fault should occur in the control system.

If all the positions of the selector lever are shown over a light background on the instrument panel display, there is a system fault and the automatic gearbox will operate in with the backup programme. When the backup programme is activated, it is possible to drive the vehicle, however, at low speeds and within a selected range of gears. In some cases **driving in reverse gear may not be possible.**

CAUTION

If the gearbox operates with the backup programme, take the vehicle to a specialised workshop and have the fault repaired without delay.

Indications on the instrument panel display

Clutch

 Clutch overheating! Please stop!

The clutch has overheated and could be damaged. Stop the vehicle and wait for the gearbox to cool with the engine at idling speed and the selector lever in position P. When the warning lamp and the driver message switch off, have the fault corrected by a specialised workshop without delay. If the warning lamp and the driver message do not switch off, do not continue driving. Seek specialist assistance.

Gearbox malfunctions

⚠ Gearbox: Fault! Stop the vehicle and place the lever in the position P.

There is a fault in the gearbox. Stop the vehicle in a safe place and do not continue driving. Seek specialist assistance.

⚠ Gearbox: System fault! You may continue driving.

Have the fault corrected by a specialised workshop without delay.

⚠ Gearbox: System fault! You can continue driving with restrictions. Reverse gear disabled

Take the vehicle to a specialised workshop and have the fault repaired without delay.

⚠ Gearbox: System fault! You can continue driving in D until switching off the engine

Stop the vehicle in a safe place well away from moving traffic. Seek specialist assistance.

⚠ Gearbox: too hot. Adapt your driving accordingly

Continue driving at moderate speeds. When the warning lamp switches off, you can continue driving in a normal manner.

⚠ Gearbox: press the brake and engage a gear again.

If the fault was caused by a gearbox with a high temperature, this driver message will be displayed when the gearbox has cooled again.

Address

Introduction to the subject

Electro-mechanical power steering assists the driver when steering.

Electro-mechanical power steering adapts *electronically* to the speed of the car, torque and turning angle.

If the power steering should fail at any time or the engine is switched off (for instance when being towed), the car can still be steered. However, more effort than normal will be required to turn the steering wheel.

Driver lamps and indications

⚠ It lights up red

Faulty steering! Parking the vehicle
If the warning lamp remains on and the driver indication appears, the power steering could be faulty. **Do not** keep driving. Seek specialist assistance.

⚠ It lights up yellow

Address: System fault! You can keep driving
If the warning lamp comes on, the steering could react with more difficulty or more sensitivity than normal. In addition, when driving in a straight line the steering wheel may be off-centre.
Drive slowly to a specialised workshop and have the fault repaired.

Steering lock: fault! Go to an Official Service

The electronic steering lock is malfunctioning. Take the vehicle to a specialised workshop as soon as possible and have the fault repaired.

The control lamp should light up for a few seconds when the ignition is switched on. It should go out once the engine is started.

⚠ WARNING

If the warning lamps and the corresponding messages are ignored when they light up, the vehicle may stall in traffic and cause accidents and severe injuries.

- Never ignore the warning lamps or messages.

»

- Stop the vehicle at the next opportunity and in a safe place.

WARNING

Take it immediately to a specialised workshop and have the fault repaired: risk of accident!

CAUTION

Failure to heed the control lamps and corresponding text messages when they light up may result in damage to the vehicle.

Note

If the lamp  (in red yellow) lights up briefly, you may continue driving.

Run-in and economical driving

Running in the engine

A new vehicle should be run in over a distance of 1500 km (1000 miles). For the first 1,000 km the engine speed should not exceed 2/3 of the maximum permissible engine speed. In doing so, do not accelerate at full throttle and do not drive with a trailer! From 1000 to 1500 km (600 to 1000 miles) you can gradually increase the engine rpm and road speed.

During its first few hours of running, the internal friction in the engine is greater than later on when all the moving parts have bedded down.

How the vehicle is driven for the first 1,500 km influences the future engine performance. Subsequently, also drive at a moderate rate, especially when the engine is still cold: this will lead to less engine wear and tear and will prolong its useful life.

You should also avoid driving with the engine speed too *low*. Change down to a lower gear when the engine no longer runs “smoothly”. If the engine revs too much, cut fuel injection to protect the engine.

Environmental compatibility

Environmental protection is a top priority in the design, choice of materials and manufacture of your new vehicle.

Constructive measures to encourage recycling

- Joints and connections designed for easy dismantling.
- Modular construction to facilitate dismantling.
- Increased use of single-grade materials.

- Plastic parts and elastomers are marked in accordance with ISO 1043, ISO 11469 and ISO 1629.

Choice of materials

- Use of recycled materials.
- Use of compatible plastics in the same part if its components are not easily separated.
- Use of recycled materials and/or materials originating from renewable sources.
- Reduction of volatile components, including odour, in plastic materials.
- Use of CFC-free coolants.

Ban on heavy metals, with the exceptions dictated by law (Annex II of ELV Directive 2000/53/EC): cadmium, lead, mercury, hexavalent chromium.

Manufacturing methods

- Reduction of the quantity of thinner in the protective wax for cavities.
- Use of plastic film as protection during vehicle transport.
- Use of solvent-free adhesives.
- Use of CFC-free coolants in cooling systems.
- Recycling and energy recovery from residues (RDF).
- Improvement in the quality of waste water.

- Use of systems for the recovery of residual heat (thermal recovery, enthalpy wheels, etc.).
- The use of water-soluble paints.

Economical and environmentally-friendly driving

Fuel consumption, environmental pollution and wear to the engine, brakes and tyres depends largely on driving style. Fuel consumption can be reduced by 10-15% with an economical driving style and proper anticipation of traffic conditions. The following section gives you some tips on lessening the impact on the environment and reducing your operating costs at the same time.

Foresight when driving

Acceleration causes the vehicle to consume more fuel. If you think ahead when driving, you will need to brake less and thus accelerate less. Wherever possible, let the car roll slowly to a stop, with a **gear engaged** (for instance when you can see that the next traffic lights are red). This takes advantage of the engine braking effect, reducing wear on the brakes and tyres. Emissions and fuel consumption will drop to zero due to the overrun fuel cut-off.

Changing gear to save energy

An effective way of saving is to change *in advance* to a higher gear. Running the engine at high rpm in the lower gears uses an unnecessary amount of fuel.

- Accelerate gradually and without reaching the “kick-down” position.

Avoid driving at high speed

Avoid travelling at top speed, whenever possible. Fuel consumption, emission of harmful gases and noise pollution multiply disproportionately as speed is increased. Driving at moderate speeds will help to save fuel.

Reduce idling time

In vehicles with the Start-Stop system idling is automatically reduced. In vehicles without the Start-Stop system it is worth switching off the engine, for example, at level crossings and at traffic lights that remain red for long periods of time. When an engine has reached operating temperature, and depending on the cylinder capacity, keeping it switched off for a minimum of about 5 seconds already saves more than the amount of fuel necessary for restarting.

The engine takes a long time to warm up when it is idling. Mechanical wear and pollutant emissions are also especially high during this initial warm-up phase. It is therefore best to drive off immediately after starting the en-

gine. Avoid running the engine at high speed.

Regular maintenance

Regular servicing helps in saving fuel even before the engine is started. A well-serviced engine gives you the benefit of **improved fuel efficiency** as well as maximum reliability and an enhanced resale value. A badly serviced engine can consume up to 10% more fuel than necessary.

Avoid short journeys

The engine and catalytic converter need to reach their optimal **operating temperature** in order to minimise fuel consumption and emissions.

A cold engine consumes a disproportionate amount of fuel. The engine reaches its working temperature after about four kilometres (2.5 miles), when fuel consumption will return to a normal level.

Check tyre pressure

Always make sure the tyres are inflated to the correct pressures »» page 322 to save fuel. If the pressure is below half bar, fuel consumption may increase by 5%. Due to the greater rolling resistance, under-inflation **also** increases tyre wear and impairs handling. »

Do not use **winter tyres** all year round as they increase fuel consumption by up to 10%.

Avoid carrying unnecessary loads

Given that every kilo of **extra weight** will increase the fuel consumption, it is advisable to always check the **luggage** compartment to make sure that no unnecessary loads are being transported.

Since the luggage rack increases the **aero-dynamic drag** of the vehicle, you should remove it when not needed. At speeds of 100–120 km/h (62–75 mph), this will save 12% of fuel.

Save electrical energy

The engine drives the alternator, thereby generating electricity. This implies that any increase in power consumption also increases fuel consumption! For this reason, switch off any unneeded electrical devices. Devices that use a lot of electricity includes the blower at a high setting, the rear window heating or the seat heating*.

Power management

This system helps to ensure reliable starting

The power management controls the distribution of electrical energy and thus helps to ensure that there is always enough power available to start the engine.

If a vehicle with a conventional electrical system is left parked for a long time, the battery will gradually lose its charge because certain electrical devices, such as the electronic gearbox lock continues to draw current even when the ignition is off. In some cases there may not be enough power available to start the engine.

Your vehicle is equipped with an intelligent power management system to control the distribution of electrical energy. This significantly improves reliability when starting the engine, and also prolongs the useful life of the battery.

The main functions incorporated in the power management system are **battery diagnosis**, **residual current management** and **dynamic power management**.

Battery diagnosis

The battery diagnosis function constantly registers the condition of the battery. Sen-

sors detect the battery voltage, battery current and battery temperature. This enables the system to calculate the current power level and charge condition of the battery.

Residual current management

The residual current management reduces power consumption while the vehicle is parked. It controls the supply of power to the various electrical devices while the ignition is switched off. The system takes the battery diagnosis data into consideration.

Depending on the power level of the battery, switch off the individual electrical devices one after the other to prevent the battery from losing too much charge and to ensure that the engine can be started reliably.

Dynamic power management

While the vehicle is moving, this function distributes the available power to the various electrical devices and systems according to their requirements. The power management ensures that on-board systems do not consume more electrical power than the alternator can supply, and thus maintains the maximum possible battery power level.

Note

- Neither is the power management system able to overcome the given physical limits.

Please remember that the power and useful life of the battery are limited.

- When there is a risk that the vehicle will not start, the alternator power failure or low battery charge level warning lamp will be shown  » page 109.

Flat battery

Starting ability has first priority.

Short trips, city traffic and low temperatures all place a heavy load on the battery. In these conditions a large amount of power is consumed, but only a small amount is supplied. The situation is also critical if electrical devices are in use when the engine is not running. In this case power is consumed when none is being generated.

In these situations you will be aware that the power management system is intervening to control the distribution of electrical power.

When the vehicle is parked for long periods

If you do not drive your vehicle for a period of several days or weeks, the power management will gradually shut off the electrical devices one by one or reduce the amount of current they are using. This limits the amount of power consumed and helps to ensure reliable starting even after a long pe-

riod. Some convenience functions, such as remote vehicle opening, may not be available under certain circumstances. These functions will be restored when you switch on the ignition and start the engine.

With the engine switched off

For example, if you listen to the sound system with the engine switched off the battery will run down.

If the energy consumption means there is a risk that the engine will not start, a text will appear in vehicles with a driver information system*.

This driver indicator tells you that you must start the engine so that the battery can recharge.

When the engine is running

Although the alternator generates electrical power, the battery can still become discharged while the vehicle is being driven. This can occur when a lot of power is being consumed but only a small amount supplied, especially if the battery is not fully charged initially.

To restore the necessary energy balance, the system will then temporarily shut off the electrical devices that are using a lot of power, or reduce the current they are consuming. Heating systems in particular use a large amount of electrical power. If you notice, for

instance, that the seat heating* or the rear window heater is not working, they may have been temporarily switched off or regulated to a lower heat output. These systems will be available again as soon as sufficient electrical power is available.

You may also notice that the engine runs at a slightly faster idling speed when necessary. This is quite normal, and no cause for concern. The increased idling speed allows the alternator to meet the greater power requirement and charge the battery at the same time.

Engine management and emission control system

Introduction

WARNING

- Because of the high temperatures which can occur in the exhaust purification system (catalytic converter or particulate filter), do not park the vehicle where the exhaust can come into contact with flammable materials under the car (e.g. on grass or at the forest edge). Fire hazard!
- Do not apply wax underneath the vehicle around the area of the exhaust system: Fire hazard!

Control lights

It lights up

Fault in the emission control system. (e.g. faulty lambda sensor).
Reduce speed and drive carefully to the nearest specialised workshop to have the engine checked.

Flashes

Combustion fault which could damage the catalytic converter.
Reduce speed and drive carefully to the nearest specialised workshop to have the engine checked.

EPC It lights up

Fault in the management of the gasoline engine.
Have the engine checked by a specialised workshop as soon as possible.

The warning lamp **EPC** (Electronic Power Control) lights up when the ignition is switched on while system operation is being verified. It should go out once the engine is started.

Note

While the  or **EPC** control lamps are on, there may be faults in the engine, fuel consumption may go up and the engine might lose power.

Catalytic converter

To maintain the useful life of the catalytic converter

- Use only unleaded petrol with petrol engines, as lead damages the catalytic converter.
- Do not let the fuel get too low in the tank.
- For engine oil changes, do not replenish with too much engine oil >>> page 315, Topping up engine oil.
- Never tow the vehicle to start it, use jump leads if necessary >>>  page 52.

If you notice misfiring, uneven running or loss of power when the vehicle is moving, reduce speed immediately and have the vehicle inspected at the nearest specialised workshop. In general, the exhaust warning lamp  will light up when any of the described symptoms occur. If this happens, unburnt fuel can enter the exhaust system and escape into the environment. The catalytic converter can also be damaged by overheating.

CAUTION

Never run the fuel tank completely dry because the irregularity of the fuel supply may cause ignition problems. This allows unburnt fuel to enter the exhaust system, which could cause overheating and damage the catalytic converter.

For the sake of the environment

Even when the emission control system is working perfectly, there may be a smell of sulphur from the exhaust gas under some conditions. This depends on the sulphur content of the fuel used. Quite often the problem can be solved by changing to another brand of fuel.

Driving tips

Driving on flooded roads

To prevent damage to the vehicle when driving through water, for example, along a flooded road, please observe the following:

- The water should never come above the lower edge of the bodywork.
- Drive at pedestrian speed.

WARNING

After driving through water, mud, sludge, etc., the braking effect can be delayed slightly due to moisture build-up on the discs and brake pads. Applying the brakes carefully several times will remove the moisture and restore the full braking effect.

ⓘ CAUTION

- Driving through flooded areas may severely damage vehicle components such as the engine, transmission, running gear or electrical system.
- Whenever driving through water, the Start-Stop system* must be switched off >>> page 238.

ℹ Note

- Check the depth of the water before entering the flooded zone.
- Do not stop in the water, drive in reverse, or stop the engine in any situation.
- Note that vehicles travelling in the opposite direction may splash water that could exceed the maximum permitted water height for your vehicle.
- Avoid driving through salt water (corrosion).

Total traction (4Drive)

On four-wheel drive models, the engine power is distributed to all four wheels

General notes

On four-wheel drive vehicles, the engine power is distributed to all four wheels. The distribution of power is controlled automati-

cally according to your driving style and the road conditions. Also see >>> page 221.

The four-wheel drive is specially designed to complement the superior engine power. This combination gives the vehicle exceptional handling and performance capabilities, both on normal roads and in more difficult conditions, such as snow and ice. Even so (or perhaps especially for this reason), it is important to observe certain safety points >>> ⚠.

Winter tyres

Thanks to four-wheel drive, your vehicle will have plenty of traction in winter conditions, even with the standard tyres. Nevertheless, we still recommend that winter tyres or all-season tyres be fitted on all *four* wheels to give even better *braking response*.

Snow chains

On roads where snow chains are mandatory, this also applies to cars with four-wheel drive >>> 📖 page 50.

Changing tyres

On vehicles with four-wheel drive, all four tyres must have the same rolling circumference. Also avoid using tyres with varying tread depths >>> page 324.

Off-roader?

Your CUPRA vehicle is not an off-roader: it does not have enough ground clearance to be used as such. It is therefore best to avoid rough tracks and uneven terrain as much as possible.

⚠ WARNING

- Even with four-wheel drive, you should always adjust your speed to suit the conditions. Do not let the extra safety features tempt you into taking any risks when driving. Risk of accident!
- The braking capability of your vehicle is limited by the tyres' grip. It is therefore no different from a car without four-wheel drive. So do not be tempted to drive too fast on firm or slippery roads just because the vehicle still has good acceleration in these conditions. Risk of accident!
- On wet roads bear in mind that the front wheels may start to "aquaplane" and lose contact with the road if the car is driven too fast. If this should happen, there will be no sudden increase in engine speed to warn the driver, as occurs with a front-wheel drive car. For this reason you should always choose a driving speed suitable for the road conditions. Risk of accident!

Driver assistance systems

Start-Stop system

Control lamps

It lights up

The Start-Stop system is available, the automatic engine shutdown is active.

It lights up

The Start-Stop system is not available.

Instructions for the driver on the instrument panel display

Start-Stop system deactivated. Start the engine manually

This driver message is displayed when certain conditions are not met during the stopping phase and the Start-Stop system **cannot** restart the engine. The engine must be started manually.

Start-Stop system: Fault! Function not available

There is a fault in the Start-Stop system. Take the vehicle to a workshop to have the fault repaired.

Description and operation

The Start-Stop system helps save fuel and reduce CO₂ emissions.

In Start-Stop mode, the engine will automatically switch off when the vehicle stops or is stopping; for example when stopping at traffic lights. The ignition remains switched on during the stopping phase. The engine automatically switches back on when required. In this situation, the light of the **START ENGINE STOP** button stays on.

As soon as the ignition is switched on, the Start-Stop function is automatically activated.

Further information about the Start-Stop system can be found on the Easy Connect system: by pressing the button **CAR** in the **Vehicle status** menu.

Stopping and starting the engine

- Use the foot brake to bring the vehicle to a stop and keep the brake pedal pressed down with your foot. The engine will switch off. The warning lamp  will appear in the display. The engine may stop before the vehicle comes to a halt in the deceleration phase (at 7 km/h or 2 km/h, depending on the vehicle's gearbox).
- When you take your foot off the brake pedal the engine will start up again. The warning lamp will switch off. In vehicles with

the Auto Hold* system, when the system is active, the engine will not start if you remove your foot from the brake pedal. The car starts when you press the accelerator pedal.

Basic requirements for the Start-Stop mode

- The driver door must be closed.
- The driver must have their seat belt fastened.
- The bonnet must be closed.
- The engine must have reached a minimum service temperature.
- The reverse gear must not be engaged.
- The vehicle must not be on a very steep slope.

The system can interrupt the Start-Stop mode frequently for different reasons.



The engine does not switch off

Before the stopping phase, the system verifies whether certain conditions are met. The engine **does not** switch off, in the following situations for example:

- The engine has not yet reached the minimum required temperature for the Start-Stop mode.
- The interior temperature selected for the air conditioner has not yet been reached.
- The interior temperature is very high/low.

- Defrost function button activated
»»  page 39.

- The parking aid* is switched on.
- The battery is very low.
- The steering wheel is overly turned or is being turned.
- If there is a danger of misting.
- After engaging reverse gear.
- In case of a very steep gradient.

The indication  is shown on the instrument panel display, and in addition, the driver information system* shows, START  STOP.

The engine starts by itself

During a stopping phase the normal Start-Stop mode can be interrupted in the following situations: The engine restarts by itself without involvement from the driver.

- The interior temperature differs from the value selected on the air conditioner.
- Defrost function button activated
»»  page 39.
- The brake has been pressed several times consecutively.
- The battery is too low.
- High power consumption.

Additional information related to the automatic gearbox

The engine stops with the selector lever in the P, D and N positions. If the selector lever is in P, the engine will also remain off when the foot is removed from the brake pedal. In order to start the engine up again the accelerator must be pressed, or another gear engaged or the brake released.

If the selector lever is placed in position R during the stopping phase, the engine will start up again.

When you place the selector lever in the S position or in the Tiptronic mode, the Start/Stop system will prevent the engine from switching off.

Change from position D to P to prevent the engine from accidentally starting when changing and passing by position R.

Additional information about vehicles with Adaptive Cruise Control (ACC)

In vehicles with ACC function, the engine will start up again in certain operating conditions if the radar sensor detects that the vehicle ahead drives off again.

WARNING

- Never switch the engine off until the vehicle is stationary. The brake servo and power steering functions will not be completely covered under warranty. More force

may also be needed to turn the steering wheel or to brake. As you cannot steer and brake in the normal manner, there is a greater risk of accidents and serious injury.

- Never remove the key from the ignition if the vehicle is in motion. Otherwise, the steering could lock making it impossible to steer the vehicle.
- To avoid injury, make sure that the Start-Stop system is switched off when working in the engine compartment »» page 240.

CAUTION

The Start-Stop system must always be switched off when driving through flooded areas »» page 240.

Note

- You can control whether the engine should switch off or not by reducing or increasing the brake force applied. While the vehicle remains stopped, the engine will not stop if the brake pedal is slightly pressed, in traffic jams with frequent stopping and starting for example. As soon as strong pressure is applied to the brake pedal, the engine will stop.
- If the selector lever is placed in position D, N or S after engaging reverse gear, the vehicle must be driven at a speed faster than 10 km/h (6 mph) for the system to return to conditions in which the engine can be stopped.

Manually switching on/off the Start-Stop system



Fig. 200 Centre console: Start-Stop system button.

If you do not wish to use the system, you can switch it off manually.

- To manually switch on/off the Start-Stop system, press the  button >>> **Fig. 200**.

The button symbol  remains lit up yellow when the system is switched off.

Note

The system is automatically switched on each time the engine is deliberately stopped during a stopping phase. The engine will start automatically.

Hill Descent Control (HDC)

Control lamps



It lights up white

Hill Descent Control is active.



It lights up grey

Hill Descent Control is not active. The system is switched on, but is not adjusting.

Some control and warning lamps will light up briefly when the ignition is switched on to check certain functions. They will switch off after a few seconds.

WARNING

Observe the safety warnings >>>  in Control and warning lamps on page 109.

Description and operation

Hill Descent Control limits the speed on steep descents by automatically braking all four wheels, both when moving forward and in reverse. As the anti-lock brake system remains active, it prevents the wheels from locking.

After starting the descent of a slope below 30 km/h (18 mph), speed is limited to a mini-

imum of 2 km/h (1 mph) and a maximum of 30 km/h (18 mph). When appropriate, the driver may increase or decrease the speed within the limit by pressing the accelerator or the brake. At this point the function is interrupted and, if necessary, it is then reactivated.

Even so, it is imperative that the surface guarantees sufficient adhesion. For this reason, the Hill Descent Control **will not** fulfil its function when, for example, descending a slope with a frozen or slippery surface.

Hill Descent Control is available when the dash panel display shows the message .

Hill Descent Control automatically intervenes if the following conditions are met:

- The vehicle engine is running.
- The **Offroad** driving profile has been selected >>> page 271. Driving at a speed below 30 km/h (18 mph) (the message  is shown on the dash panel display).
- The slope of the descent is at least 10% when driving forward and 9% when driving in reverse.
- The brake and the accelerator are not pressed.

Hill Descent Control is deactivated on pressing the brake and the accelerator or if the slope is below 5%. The function may be disconnected manually in the Easy Connect

system by pressing the **CAR** button > HDC function button >>>  Fig. 42.

WARNING

Always be ready to brake. Otherwise, an accident could occur and cause injury.

- Hill Descent Control is only an auxiliary system that in some situations may not sufficiently brake the vehicle when going down a slope.
- The speed of the vehicle may increase despite the intervention of Hill Descent Control.

Auto Hold Function

Description and operation

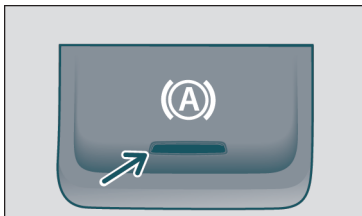

Fig. 201 In the lower part of the centre console: Auto Hold function button.

The control light of the **(A)** >>> **Fig. 201** button remains on when the Auto Hold function is connected.

Once connected, the Auto Hold function assists the driver in keeping the vehicle stationary at repeated intervals or for a certain period of time with the engine running, for example, when going up a slope, when stopped at traffic lights or in heavy traffic with intermittent stops.

When connected, the Auto Hold function automatically prevents the vehicle from rolling when stationary without pressing the brake pedal.

After detecting that the vehicle is stationary and the brake pedal has been released, the Auto Hold function holds the vehicle. The driver can lift their foot off the brake pedal.

When the driver touches the accelerator pedal or accelerates slightly to continue driving, the Auto Hold function releases the brake. The vehicle moves according to the slope of the road.

If the vehicle is stationary and one of the conditions required by the Auto Hold function is impaired, it disconnects itself and the button's control light goes out >>> **Fig. 201**. The electronic parking brake connects automatically, if necessary, to park the vehicle safely >>> .

Conditions for keeping the vehicle stationary with the Auto Hold function

- The driver door must be closed.
- The driver's seat belt must be fastened.
- The engine is running.

Switching the Auto Hold function on and off

Press the button **(A)** >>> . The control lamp on the button goes out when the Auto Hold function is switched off.

Automatically engaging and disengaging the Auto Hold function

If the Auto Hold function was switched on with the **(A)** button before disengaging the ignition, the function will remain on after the ignition is re-engaged.

If the Auto Hold function was not switched on, it will automatically remain off next time the ignition is engaged.

The Auto Hold function is automatically switched on if the following conditions are met:

All conditions must be met at the same time >>> :

1. The vehicle is kept stationary with the brake pedal on a flat surface or on a slope.
2. The engine rotates "correctly".

»

All conditions must be met at the same time

»» » ▲:

Upon accelerating, the brake releases gradually.

The Auto Hold function is automatically turned off if the following conditions are met:

1. If any of the conditions mentioned on »» » page 241, Conditions for keeping the vehicle stationary with the Auto Hold function are no longer met.
2. If the engine is running irregularly or an anomaly is detected.
3. If the engine is switched off.
4. If the accelerator is pressed.
5. If any of the tyres has only minimal contact with the ground, e.g. in the case of axle articulation.

▲ WARNING

The smart technology incorporated into the Auto Hold function cannot defy the laws of physics; it only works within the limits of the system. The greater convenience provided by the Auto Hold function should never tempt you to take any risk that may compromise safety.

- Never leave the vehicle running and with the Auto Hold function switched on.
- The Auto Hold function cannot always keep the vehicle stationary uphill or down-

hill or stop it sufficiently, for example, on slippery or frozen surfaces.

i Note

Before entering a car wash, always switch off the Auto Hold function, because if the electronic parking brake is automatically connected, it may cause damage.

Cruise control system (CCS)*

Control lamp



It lights up green

The Cruise Control System (GRA) is switched on and active.

OR: The Adaptive Cruise Control system (CCS) is switched on and active.

OR: the speed limiter is switched on and active.

Several warning and control lamps light up for a few seconds when the ignition is switched on, signalling that the function is being verified. They will switch off after a few seconds.

▲ WARNING

Observe the safety warnings »» » ▲ in Control and warning lamps on page 109.

Cruise control operation

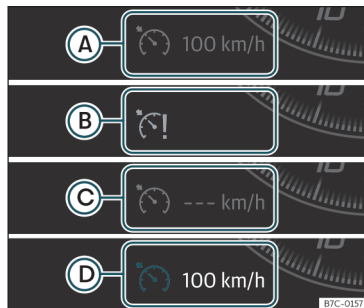

Fig. 202 Instrument panel display: CCS status indications.

Read the additional information carefully

»» » page 37

The cruise control system (CCS) is able to maintain the set speed from 20 km/h (15 mph).

The CSS only reduces vehicle speed by ceasing to accelerate, not by actively braking the vehicle »» » ▲.

Displayed on the CCS screen

Status Fig. 202:

- A CCS temporarily switched off. The set speed is displayed in small or darkened figures.
- B System error. Contact a specialised workshop.
- C CCS switched on. The speed memory is empty.
- D The CCS is switched on. The set speed is displayed in large figures.

Changing gear in CCS mode

The CCS decelerates as soon as the clutch pedal is pressed, intervening again automatically after a gear is engaged.

Travelling down hills with the CCS

When travelling down hills the CCS cannot maintain a constant speed. Slow the vehicle down using the brake pedal and reduce gears if required.

Automatic off

The cruise control system (CCS) is switched off automatically or temporarily:

- If the system detects a fault that could affect the working order of the CCS.
- If you press and maintain the accelerator pedal for a certain time, driving faster than the stored speed.
- If the dynamic driving control systems intervene (e.g. ASR or ESC).

- If the airbag is triggered.

WARNING

Use of the cruise control could cause accidents and severe injuries if it is not possible to drive at a constant speed maintaining the safety distance.

- Do not use the cruise control in heavy traffic, if the distance from the vehicle in front is insufficient, on steep roads, with several bends or in slippery circumstances (snow, ice, rain or loose gravel), or on flooded roads.
- Never use the CCS when driving off-road or on unpaved roads.
- Always adapt your speed and the distance to the vehicles ahead in line with visibility, weather conditions, the condition of the road and the traffic situation.
- To avoid unexpected operation of the cruise control system, turn it off every time you finish using it.
- It is dangerous to use a set speed which is too high for the prevailing road, traffic or weather conditions.
- When travelling down hills, the CCS cannot maintain a constant speed. The vehicle tends to accelerate under its own weight. Select a lower gear or use the foot brake to slow the vehicle.

WARNING

Observe the safety warnings >>>  in Control and warning lamps on page 109.

Speed limiter

Control lamp



It lights up green

The speed limiter is switched on and active.



Flashes green

The speed set by the speed limiter has been exceeded.



It lights up

The adaptive cruise control (ACC) and the speed limiter are active.

Some warning and control lamps will light up briefly when the ignition is switched on to check certain functions. They will switch off after a few seconds.

WARNING

Observe the safety warnings >>>  in Control and warning lamps on page 109.

Display indications

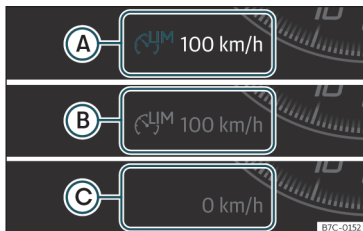

Fig. 203 On the instrument panel display: indications of the speed limiter status.

The speed limiter helps avoid exceeding a speed individually programmed upwards of approximately 30 km/h (19 mph) driving in forwards gears >>>

Display messages on the speed limiter

Status >>> **Fig. 203:**

- (A) The speed limiter is active. The last speed set is displayed in large figures.
- (B) The speed limiter is not active. The last speed set is displayed in small or darkened figures.
- (C) The speed limiter is switched off. The total mileage is displayed.

WARNING

After use, always switch off the speed limiter to prevent the speed being regulated against your wishes.

- The speed limiter does not relieve the driver of their responsibility to drive at the appropriate speed. Do not drive at high speed if not necessary.
- Using the speed limiter under adverse weather conditions is dangerous and can cause serious accidents, e.g. aquaplaning, snow, ice, leaves, etc. Only use the speed

limiter when the status of the road and the weather conditions allow it.

- When driving downhill, the speed limiter cannot limit the vehicle speed. Its speed will increase due to its own weight. In this case, select a lower gear or use the foot brake to slow the vehicle.

Note

- Different versions of the instrument panel are available and therefore the versions and instructions on the display may vary.
- If when switching the ignition off, the cruise control system (CCS), the adaptive cruise control (ACC) or the speed limiter were switched on, then the cruise control system or the adaptive cruise control will automatically switch themselves on when the ignition is back on. However, no speed will be stored. The last set speed of the speed limiter will be stored.

Operate the speed limiter

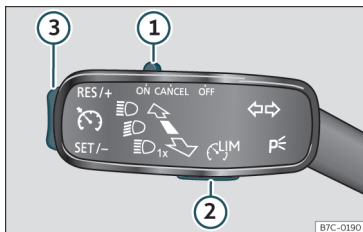

Fig. 204 On the left of the steering column: control and buttons to operate the speed limiter.

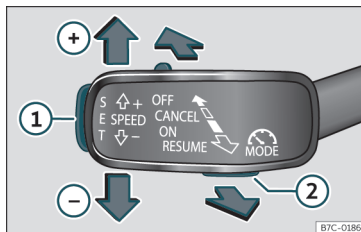

Fig. 205 On the left of the steering column: third lever for operating the speed limiter.

Function	Position of the turn signal lever »» Fig. 204 or the third lever »» Fig. 205	Effect
Switching on the speed limiter	Move controller ① of the turn signal lever to the ON position and press button ② or move the third lever forward and press button ②.	The system switches on. The last set speed of the speed limiter is stored. It does not take effect yet.
Switching between the speed limiter and cruise control (CCS) or the adaptive cruise control (ACC) (with the speed limiter switched on)	Press button ② on the turn signal lever or button ② on the third lever	It switches between the speed limiter and the CCS or the adaptive cruise control (ACC).
Activating the speed limiter	Press the button ③ on the turn signal lever or button SET ① on the third lever.	The current speed is stored as the maximum speed and the limiter is switched on.
Temporarily switching off the speed limiter limitation	Place control ① of the turn signal lever in position CANCEL or move the third lever into position CANCEL .	The limiter is switched off temporarily. The speed will be stored.
Temporarily switch off the speed limiter limitation pressing down the accelerator (kick-down)	Press down on the accelerator beyond the point of resistance (e.g. to overtake). Surpassing the set speed switches the speed limiter off temporarily.	The limiter is switched off temporarily. The speed will be stored. The limiter is reactivated automatically after returning to less than the set speed.

»

Function	Position of the turn signal lever >>> Fig. 204 or the third lever >>> Fig. 205	Effect
Switching the speed limiter on again	Press button ③ on the turn signal lever or move the third lever into position RESUME .	The speed is limited to the set speed as soon as the speed you are driving at is lower than the speed set as maximum.
Increasing the set speed of the limiter	Briefly press button ③ on the turn signal lever in the RES/+ area or move the third lever into position RESUME to increase the speed in small increments of 1 km/h (1 mph) and set it.	The speed is limited to the set value
	Press SPEED+ on the third lever to increase the speed in increments of 10 km/h (5 mph) and set it. Hold down the button ③ on the turn signal lever in the RES/+ area or hold down SPEED+ to increase continuously in increments of 10 km/h (5 mph) and set it.	
Reducing the set speed of the limiter	Briefly press button ③ on the turn signal lever in the SET/- area or press SET ① on the third lever to reduce the speed in small increments of 1 km/h (1 mph) and set it.	The speed is limited to the set value
	Press SPEED- on the third lever to reduce the speed in increments of 10 km/h (5 mph) and set it.	
	Hold down the button ③ on the turn signal lever in the SET/- area or hold down SPEED- to continuously decrease the speed in increments of 10 km/h (5 mph), then set it.	
Switching off the speed limiter	Move control ① of the turn signal lever into position OFF or the third lever into position OFF .	The system switches off

The values shown in the table in brackets, in mph, are displayed only in instrument panels with indications in miles.

Going down slopes with the speed limiter

If the set speed of the speed limiter is exceeded while driving downhill, soon afterwards the warning and control lamps (⚠)

>>> page 243 flash and an acoustic warning may sound. In this case, use the foot brake to slow the vehicle or, if necessary, select a lower gear.

Switching off temporarily

If you wish to temporarily switch off the speed limiter, e.g. to overtake, move control

>>> Fig. 204 ① of the turn signal lever into position **CANCEL** or the third lever into pressure point **CANCEL** or press button ② on any lever.

After overtaking, the speed limiter can be switched on with the previously set speed by pressing button ③ on the turn signal lever in the area **RES/+** or by moving the third lever into pressure point **RESUME**.

Switch the speed limiter off temporarily by pressing down the accelerator (kick-down)

If the accelerator is pressed right down (kick-down) and the set speed is exceeded because driver wishes to do so, the limiter is temporarily disabled.

To confirm it being switched off an acoustic signal sound once. While the limiter is off, the warning and control lamp (🚗) flashes.

When the accelerator is no longer pressed down and the speed is reduced below the set value, the limiter switches on again. The control lamp (🚗) will light up and remain lit.

Automatic off

The speed limiter is automatically switched off:

- If the system detects a fault that could negatively affect the working order of the limiter.
- If the airbag is triggered.

ⓘ CAUTION

For automatic switching off due to system failures, for security reasons, the limiter is only completely switched off when the driver stops pressing the accelerator at some point or consciously switches off the system.

Emergency braking assistance system (Front Assist)*

Topic introduction



Fig. 206 On the instrument panel display: advance warning indications.

The objective of the emergency braking assistance system is to prevent head-on collisions against objects that may be in the vehicle's path or minimise the consequences of such impacts.

Within the limitations imposed by the environmental conditions and by the system itself, the function acts in staggered fashion, depending on how critical the situation is. Initially it warns the driver, and if the driver's reaction does not occur or is insufficient, it activates an independent emergency braking.

The function is intended to prevent collisions with parked vehicles or vehicles in the same lane travelling in the same direction, or with pedestrians crossing the vehicle's path. It may fail to activate in other danger situations.

The Front Assist function is active within a range of speeds between 4 km/h (2.5 mph) and 250 km/h (156 mph). Depending on speed, traffic conditions and driver behaviour, some of the sub-functions described below are omitted in order to optimise the system's general behaviour.

The Front Assist is a driving assistance function that can never replace the driver's attention.

Safety distance warning

If the system detects a situation of danger because the vehicle is too close to the vehicle ahead, it will warn the driver by means of an indication on the instrument panel display 🚗.

The timing of the warning varies depending on driver behaviour and the traffic situation.

Advance warning

If the system detects a possible collision with the vehicle in front, it may alert the driver by means of an audible warning and an indication on the instrument panel display

»» Fig. 206.

»

The warning moment varies depending on the traffic situation and driver behaviour. At the same time, the vehicle will prepare for a possible emergency braking >>> .

Critical warning

If the driver fails to react to the pre-warning (advance warning), the system may actively intervene in the brakes and generate a brief jolt to warn the driver of the imminent danger of a collision.

Automatic braking

If the driver also fails to react to the critical warning, the system may initiate independent emergency braking by progressively increasing the braking effect in accordance with how critical the situation is.

Driver emergency braking assistance system

Faced with an imminent collision, the system may detect that the driver is not braking hard enough to avoid the collision. In this case, it will automatically increase the braking effect.

Due to certain driving circumstances and the limitations of its operation, there are some cases in which the system cannot prevent a collision, although it can significantly minimise the consequences by reducing the speed and the force of the impact.

WARNING

Observe the safety warnings >>>  in Control and warning lamps on page 109.

WARNING

The Front Assist system cannot change the laws of physics or replace the driver in terms of keeping control of the vehicle and reacting to a possible emergency situation.

WARNING

Following a Front Assist emergency warning, pay immediate attention to the situation and try to avoid the collision by braking or by dodging the obstacle, as applicable.

- If the Front Assist does not work as described in this chapter (e.g. it repeatedly intervenes unnecessarily), switch it off.
- Adapt your speed and safe distance to the vehicle in front of you at all times to suit visibility, weather, road and traffic conditions.
- The Front Assist alone cannot avoid accidents and serious injuries.
- In complex driving situations, occasionally the Front Assist may issue warnings and intervene in braking unnecessarily, for example at traffic islands.
- If the operation of the Front Assist is impaired, for example, by dirt or because the radar sensor has lost its settings, the system

may issue unnecessary warnings and intervene inopportunistically in the braking.

- The Front Assist does not react to animals or vehicles crossing your path or approaching head-on down the same lane.
- The Front Assist does not react to pedestrians walking in the same direction or approaching head-on down the same lane.
- The driver must always be ready to take over the control of the vehicle.
- When the Front Assist causes a braking, the brake pedal is “harder”.
- Automatic interventions by the Front Assist on the brakes may be interrupted by pressing the clutch, accelerator or moving the wheel.

Note

- When the Front Assist is connected, the indications on the instrument panel screen may be concealed by warnings from other functions, such as an incoming call.
- When the Front Assist causes a braking, the brake pedal is “harder”.
- Automatic interventions by the Front Assist on the brakes may be interrupted by pressing the clutch, accelerator or moving the wheel.
- The Front Assist may brake the vehicle until it stops completely. However, the brake system does not halt the vehicle permanently. Use the foot brake!

- If the Front Assist does not work as described in this chapter (e.g. in intervenes several times unnecessarily), switch it off. Have the system checked by a specialised workshop. CUPRA recommends visiting a specialised CUPRA dealer or any SEAT dealership.

Radar sensor

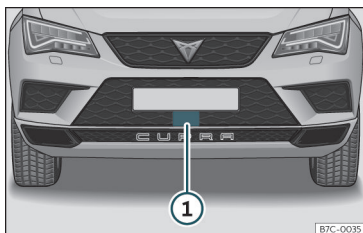

Fig. 207 On the front bumper: radar sensor.

A radar sensor is installed on the front bumper to determine the traffic situation >>> **Fig. 207** ①.

The radar sensor's visibility may be impaired by dirt, mud or snow, or by environmental influences such as rain or mist. In this case, the Front Assist does not work. The instrument panel displays the following message: **Front Assist: No sensor vision!** If necessary clean the radar sensor >>> ①.

When the radar sensor begins to operate properly again, the Front Assist will automatically be available again. The message will disappear from the instrument panel display.

Front Assist operation may be affected by a strong radar reverse reflection. This may occur, for example, in a closed car park or due to the presence of metallic objects (e.g. rails on the road or sheets used in road works).

The area in front of and around the radar sensor should not be covered with adhesives, additional or similar headlights, as this may negatively affect Front Assist operation.

If the front of the vehicle is not properly repaired or structural modifications are made to it, for example if the suspension is lowered, Front Assist operation may be affected. This is why CUPRA recommends visiting a specialised CUPRA dealer or any SEAT dealership.

⚠ CAUTION

If you have the sensation that the radar sensor is damaged or has lost its settings, disconnect the Front Assist. This will avoid possible dangerous situations caused by a system malfunction. If this occurs have it adjusted.

- The sensor may become damaged or lose its settings when knocked, for example, during a parking manoeuvre. This may

compromise the system's efficacy or disconnect it.

- Repairs to the radar sensor require specialist knowledge and special tools. This is why CUPRA recommends visiting a specialised CUPRA dealer or any SEAT dealership.
- Clean away the snow with a brush and the ice preferably with a solvent-free de-icer spray.

Operating the Emergency braking assistance system (Front Assist)

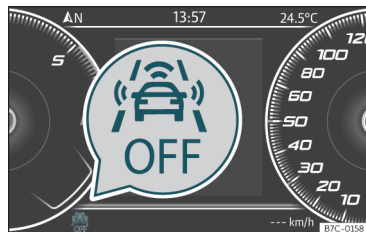

Fig. 208 On the screen of the instrument panel Front Assist switched off message.

The Front Assist is active whenever the ignition is switched on.

When the Front Assist is switched off, so too are the advance warning function (pre warning) and the distance warning. >>>

CUPRA recommends leaving the Front Assist always switched on. Exceptions >>> page 250, Switching the Front Assist off temporarily in the following situations.

Switching the Front Assist on and off

With the ignition switched on, the Front Assist can be switched on and off as follows:

- Select the corresponding menu option using the button for the driver assistance systems >>> page 109.
- **OR:** switch the system on and off in Easy Connect using the **(CAR)** button **SETTINGS > Driver assistance button** >>>  page 33.

When Front Assist is switched off, the instrument panel will inform that it has been switched off with the following indicator  >>> **Fig. 208.**

Activating or deactivating the pre-warning (advance warning)

The pre-warning function (advance warning) can be switched on or off in the Easy Connect system with the **(CAR)** button > **SETTINGS Driver assistance** function button >>>  page 33.

The system will store the setting for the next time the ignition is switched on.

CUPRA recommends keeping the pre-warning function switched on at all times.

Depending on the infotainment system installed in the vehicle, the advance warning function may be adjusted as follows:

- Advance
- Medium
- Delayed
- Deactivated

CUPRA recommends driving with the function in “Medium” mode.

Switching distance warning on and off

If the safe distance with regard to the vehicle in front is exceeded, the relevant warning will appear on the instrument panel display . In this case, increase the safe distance.

The distance warning can be switched on and off in the Easy Connect system using the **(CAR)** button > **SETTINGS > Driver assistance** >>>  page 33.

The system will store the setting for the next time the ignition is switched on.

CUPRA recommends keeping the distance warning switched on at all times.

Switching the Front Assist off temporarily in the following situations

In the following situations the Front Assist should be deactivated due to the system's limitations:

- When the vehicle is to be towed.
- If the vehicle is on a test bed.
- When the radar sensor is damaged.
- If the radar sensor takes a heavy knock, for example in a rear collision.
- If it intervenes several times unnecessarily.
- If the radar sensor is covered temporarily with some kind of accessory, such as an additional headlight or the like.
- When the vehicle is to be loaded on a lorry, ferry or train.

System limitations

The Front Assist has certain physical limitations inherent to the system. Thus, in certain circumstances, some of the system's reactions may be inopportune from the driver's standpoint. So pay attention in order to intervene if necessary.

The following conditions may cause the Front Assist not to react or to do so too late:

- In the first few instants of driving after switching on the ignition, due to the system's initial auto-calibration.
- On taking tight bends or complex paths.
- Pressing the accelerator all the way down.
- If the Front Assist is switched off or damaged.
- If the ASR has been disconnected or the ESC activated in **Sport** mode manually >>> page 223.
- If the ESC is controlling.
- If several brake lights of the vehicle or electrically connected trailer are damaged.
- If the radar sensor is dirty or covered.
- If there are metal objects, e.g. rails on the road or sheets used in road works.
- If the vehicle is reversing.
- If the vehicle over-accelerates.
- In case of snow or heavy rain.
- In case of narrow vehicles, such as motor-bikes.
- Misaligned vehicles.
- Vehicles crossing the other's path.
- Vehicles approaching in the opposite direction.

- Special loads and accessories of other vehicles that jut out over the sides, backwards or over the top.

Adaptive cruise control (ACC)*

Introduction

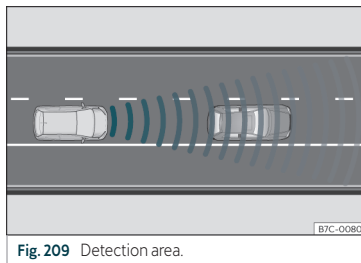

The adaptive cruise control (ACC) is an extension of the normal cruise control system (CCS) >>> .

The ACC function allows the driver to program a cruise speed of between 30 and 210 km/h (18 and 130 mph) and to select the distance required with regard to the vehicle in front.

The ACC will adapt the vehicle's cruise speed at all times, maintaining a safe distance with the vehicle in front based on its speed.

When driving behind another vehicle, the ACC function reduces speed until it is the same as that of the vehicle ahead and maintains the set distance between the vehicles. If the vehicle ahead accelerates, the adaptive cruise control also accelerates, going no higher than the target speed programmed.

If the vehicle is equipped with automatic gearbox, the ACC can brake the vehicle **until it stops completely** if a vehicle in front of it stops.

The distance programmed should be increased when the road surface is wet.

Driver intervention prompt

During driving, the ACC is subject to certain limitations inherent in the system. In other words, in certain circumstances the driver will have to adjust speed him or herself, as well as the distance from other vehicles.

In this case, the instrument panel screen *will warn you to intervene* by applying the brake and a warning tone will be heard >>> page 252.

WARNING

The intelligent technology in the ACC cannot overcome the system's inherent limitations or change the laws of physics. If used negligently or involuntarily, it may cause serious accidents and injuries. The system is not a replacement for driver awareness. »

- Adapt your speed and safe distance to the vehicle in front of you at all times to suit visibility, weather, road and traffic conditions.
- Do not use the ACC when visibility is bad, on steep roads, with several bends or in slippery circumstances such as snow, ice, rain or loose gravel, or on flooded roads.
- Never use the ACC when driving off-road or on unpaved roads. The ACC has been designed for use on paved roads only.
- The ACC does not react on approaching a fixed obstacle, such as the tail of a traffic jam, a damaged vehicle or a vehicle stopped at the traffic lights.
- The ACC only reacts to people if a pedestrian monitoring system is available. In addition, the system does not react to animals or vehicles crossing your path or approaching head-on down the same lane.
- If the ACC does not reduce speed sufficiently, brake the vehicle immediately by applying the pedal.
- If you are driving using the spare wheel, the ACC system could automatically switch off during the journey. Switch off the system when starting off.
- If the vehicle continues to move involuntarily after a driver intervention prompt, brake the vehicle by applying the pedal.
- If the dash panel displays a *driver intervention prompt*, adjust the distance yourself.

- The driver should be ready to accelerate or brake by him/herself at all times.

CAUTION

If you have the sensation that the radar sensor is damaged, disconnect the ACC. This will avoid possible damage. If this occurs have it adjusted.

- Repairs to the radar sensor require specialist knowledge and special tools. This is why CUPRA recommends visiting a specialised CUPRA dealer or any SEAT dealership.

Note

- If the ACC system does not work as described in this chapter, do not use it until it has been checked by a specialised workshop. This is why CUPRA recommends visiting a specialised CUPRA dealer or any SEAT dealership.
- Maximum speed with the ACC activated is limited to 210 km/h (130 mph).
- When the ACC is switched on, strange noises may be heard during automatic braking cause by the braking system.

Symbols on the instrument panel display and control lamps



The speed reduction by the ACC to maintain the distance from the vehicle in front is not sufficient.

Brake! apply the foot brake! Driver intervention prompt.



The ACC is not currently available.^{a)}

With the vehicle stationary, switch off the engine and start it up again. Check the radar sensor visually >>> Fig. 211  (for dirt, ice or knocks). If it is still unavailable, refer to a specialised workshop to have the system inspected.

^{a)} The symbol on the instrument panels with colour display is in colour.



The ACC is active.

No vehicle is detected in front. The programmed speed remains constant.



If the symbol is white: the ACC is active.

A vehicle in front has been detected. The ACC adjusts speed and distance from the vehicle in front.



If the symbol is grey: ACC is inactive (Standby)

The system is switched on, but is not adjusting.



It lights up green

The ACC is active.

Some control and warning lamps will light up briefly when the ignition is switched on to check certain functions. They will switch off after a few seconds.

⚠ WARNING

Observe the safety warnings >>> ⚠ in Control and warning lamps on page 109.

Indications on the display

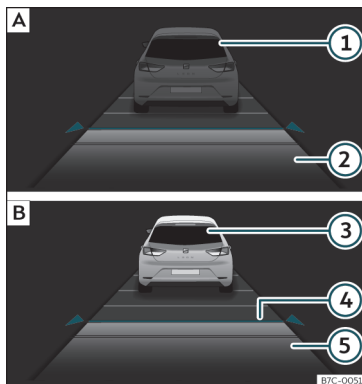

Fig. 210 On the instrument panel display: (A) ACC inactive (Standby). (B) ACC active.

Status display

Indications on the display >>> **Fig. 210:**

- ① Vehicle ahead detected. ACC is not active and is not regulating your speed.
- ② Distance from the vehicle ahead. ACC is not active and is not regulating your distance.
- ③ Vehicle ahead detected. ACC is active and is regulating your speed.
- ④ Distance level 2 set by the driver.

- ⑤ ACC is active and is regulating your distance based on speed.

i Note

When the ACC is connected, the indications on the instrument panel screen may be concealed by warnings from other functions, such as an incoming call.

Radar sensor

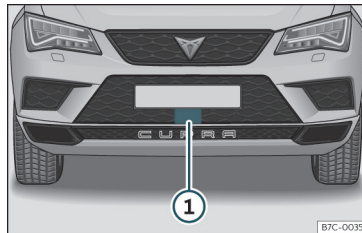

Fig. 211 On the front bumper: radar sensor.

A radar sensor is installed on the front bumper to determine the traffic situation >>> **Fig. 211** ①.

The radar sensor's visibility may be impaired by dirt, mud or snow, or by environmental influences such as rain or mist. In this case the adaptive cruise control (ACC) does not work. The instrument panel displays the following »

message: **ACC: No sensor vision!** If necessary clean the radar sensor >>> **!**

When the radar sensor begins to operate properly again, the ACC will automatically be available again. The message on the instrument panel screen will switch off and the ACC will be reactivated again.

ACC operation may be affected by a strong radar reverse reflection. This may occur, for example, in a closed car park or due to the presence of metallic objects (e.g. rails on the road or sheets used in road works).

The area in front of and around the radar sensor should not be covered with adhesives, additional or similar headlights, as this may negatively affect ACC operation.

If the front of the vehicle is not properly repaired or structural modifications are made to it, for example, if the suspension is lowered, ACC operation may be affected. This is why CUPRA recommends visiting a specialised CUPRA dealer or any SEAT dealership.

! CAUTION

If you have the sensation that the radar sensor is damaged or has lost its settings, disconnect the ACC. This will avoid possible damage. If this occurs have it adjusted.

- The sensor may become damaged or lose its settings when knocked, for example, during a parking manoeuvre. This may

compromise the system's efficacy or disconnect it.

- Repairs to the radar sensor require specialist knowledge and special tools. This is why CUPRA recommends visiting a specialised CUPRA dealer or any SEAT dealership.
- Clean away the snow with a brush and the ice preferably with a solvent-free de-icer spray.

Operating the Adaptive Cruise Control ACC

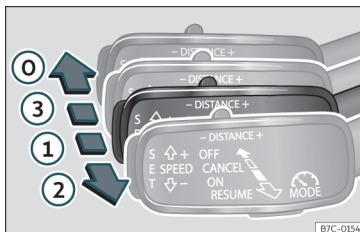

Fig. 212 On the left of the steering column: third lever for operating the Adaptive Cruise Control.

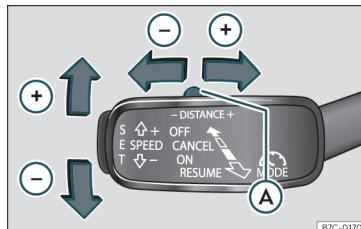

Fig. 213 On the left of the steering column: third lever for operating the Adaptive Cruise Control.

When the Adaptive Cruise Control (ACC) is connected, the green control lamp (🟢) will light up on the instrument panel, and the programmed speed and ACC status will be displayed >>> **Fig. 210**.

What ACC settings are possible?

- Setting your speed >>> page 255.
- Setting your distance >>> page 255.
- Connecting and activating the ACC >>> page 255.
- Disconnecting and deactivating the ACC >>> page 255.
- Adjusting the default distance level at the start of your journey >>> page 255.
- Adjusting the driving profile >>> page 255.
- Conditions in which the ACC does not react >>> page 255.

Setting speed

To set your speed, move the third lever located in position ① upwards or downwards until the desired speed is shown on the instrument panel display. The speed adjustment is made at 10 km/h (6 mph) intervals.

Once you are driving, if you wish to set the current speed as the vehicle's cruise speed and activate the ACC, press the **SET** >>> **Fig. 213** button. If you wish to increase or reduce speed by intervals of 1 km/h (0.6 mph), move the lever to position ② >>> **Fig. 212** or press the **SET** button, respectively.

The set speed can be changed when the vehicle is stopped or during driving, as you like. Any modification to the programmed speed will be shown on the bottom left part of the instrument panel display >>> **Fig. 210**.

Setting your distance level

To increase/reduce the distance level, press the rocker switch towards the left/right >>> **Fig. 213 A**.

The instrument panel display shows the modification of the distance level. There are 5 distance levels to choose from. CUPRA recommends level 3. The set distance can be changed when the vehicle is stopped or during driving, as you like >>> **A**.

Connecting and activating the ACC

To connect and activate the ACC, the position of the gearbox selector lever, the vehicle speed and the position of the third level of the ACC must all be taken into account.

- The gearbox selector lever must be in position **D** or **S**.
- To activate the ACC, with the third lever in position ① press the **SET** button or move the third lever of the ACC to position ② >>> **Fig. 212**. At this point, the image of the ACC on the instrument panel display will switch to Active mode >>> **Fig. 210**.

When the ACC function is active, the vehicle travels at a set speed and distance from the vehicle ahead. Both speed and distance can be changed at any time.

Disconnecting and deactivating the ACC

To disconnect the ACC move the lever to the ③ position >>> **Fig. 212** (engaged). An **ACC deactivated** message appears and the function is totally deactivated.

If you do not wish to disconnect the ACC, just to switch it temporarily to inactive mode (Standby), move the third lever to position ③ >>> **Fig. 212** or press the brake pedal.

It will also switch to inactive mode (Standby) if the vehicle is stopped and the driver door is opened.

Adjusting the default distance level at the start of your journey

In wet road conditions, you should always set a larger distance with regard to the vehicle in front than when driving in dry conditions.

The following distances can be preselected:

- Very short
- Short
- Media
- Long
- Very long

In the Easy Connect system you can adjust the distance level that will be applied when the ACC is connected using the **CAR** > **SETTINGS** > **Driver assistance** >>> **A** page 33.

Changing the driving profile

The driving profile selected can affect ACC acceleration and braking behaviour >>> page 271.

The following conditions may lead the ACC not to react:

- If the accelerator is pressed.
- If there is no gear engaged.
- If the ESC is controlling.
- If the driver is not wearing his/her seat belt.



- If several brake lights of the vehicle or electrically connected trailer are damaged.
- If the vehicle is reversing.
- Driving faster than 210 km/h (130 mph).

Driver messages

ACC not available

The system can no longer continue to guarantee safe vehicle detection and will be deactivated. The sensor has lost its setting or is damaged. Take the vehicle to a specialised workshop and have the fault repaired.

ACC and Front Assist: currently not available. No sensor vision

This message will be displayed to the driver if the radar sensor's vision is impaired due, for example, to leaves, snow, heavy fog or dirt. Clean the sensor >>> **Fig. 211.**

ACC: currently not available. Gradient too steep

The maximum road slope has been exceeded, hence safe ACC operation cannot be guaranteed. The ACC cannot be switched on.

ACC: only available in D, S or M

Select the D/S or M position on the selector lever.

ACC: parking brake applied

The ACC is deactivated if the parking brake is applied. The ACC is available once again after the parking brake is released.

ACC: currently not available. Intervention of stability control

The message for the driver is displayed when the electronic stability control (ESC) intervenes. In this case, the ACC is automatically switched off.

ACC: Take action!

The message for the driver is displayed if, when the vehicle starts up on a hill with a mild slope, the vehicle rolls back even although the ACC is activated. Apply the brake to stop the vehicle from moving/colliding with another vehicle.

ACC: engine speed

The message for the driver is displayed if, when the ACC accelerates or brakes, the driver does not shift up or down a gear in time, which means exceeding or not reaching the permissible engine speed. The ACC switches itself off. A buzzer warning is heard.

Door open

Vehicles with automatic transmission: the ACC cannot be activated with the vehicle stationary and the door open.

WARNING

There is a danger of rear collision when the minimum distance to the vehicle in front is exceeded and the speed difference between both vehicles is so great that a speed reduction by the ACC will not suffice. In this case the brake pedal should be applied immediately.

- The ACC may not be able to detect all situations properly.
- “Stepping” on the accelerator may cause the ACC not to intervene in braking. Driver braking will have priority over intervention by the speed control or adaptive cruise control.
- Always be ready to use the brakes!
- Observe country-specific provisions governing obligatory minimum distances between vehicles.

Note

- The programmed speed is erased once the ignition or the ACC are switched off.
- When the traction control system (ASR) is deactivated during acceleration or else the ESC is activated in Sport* Mode (>>>  page 33), the ACC switches off automatically.
- In vehicles with the Start-Stop system, the engine switches off automatically during the ACC stopping phase and restarts automatically to begin driving.

Function for preventing overtaking in an inside lane

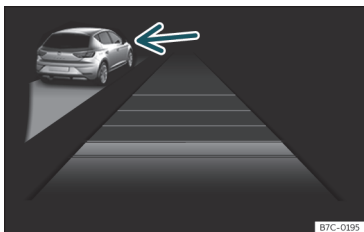



Fig. 214 On the instrument panel display: ACC active, vehicle detected in an outer lane.

The adaptive cruise control (ACC) has a function that helps avoid overtaking while driving in inside lanes at certain speeds.

If another vehicle is detected travelling at a slower speed in an outer lane, it is displayed on the multifunction display >>> **Fig. 214**.

To avoid overtaking while driving in an inside lane the system will gently brake, and in accordance with the speed will prevent the car from overtaking. The driver can override this function at any time by pressing the accelerator pedal. At low speeds the function is inactive, for greater comfort in a traffic jam or in city traffic.

Deactivating the Adaptive Cruise Control ACC temporarily in certain situations

In the following situations the Adaptive Cruise Control (ACC) should be deactivated due to the system's limitations >>> :

- When changing lanes, on tight bends and roundabouts, in acceleration and deceleration lanes on motorways or in sections with road works to prevent involuntary acceleration to reach the programmed speed.
- When going through a tunnel, as operation could be affected.
- On roads with several lanes, when other vehicles are driving more slowly in the overtaking lane. In this case, slower vehicles will be overtaken on the right.
- In case of heavy rain, snow or spray, as the vehicle in front might not be detected properly or, in certain circumstances, might not be detected at all.

WARNING

If the ACC does not switch off in the situations described, serious accidents and injuries may occur.

- Always switch off the ACC in critical situations.

Note

If you do not switch off the ACC in the aforementioned situations, you may commit a legal offence.

Special driving situations

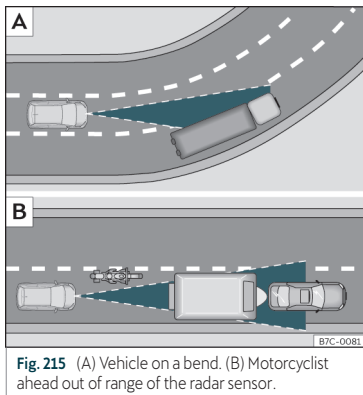

Fig. 215 (A) Vehicle on a bend. (B) Motorcyclist ahead out of range of the radar sensor.

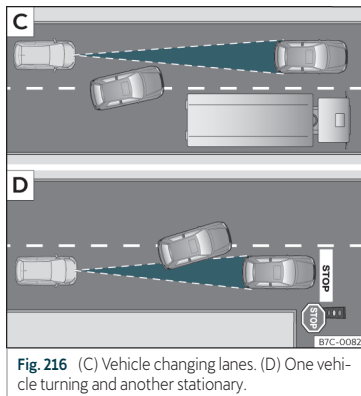



Fig. 216 (C) Vehicle changing lanes. (D) One vehicle turning and another stationary.

The adaptive cruise control (ACC) has certain physical limitations inherent in the system. For example, certain reactions of the ACC, in certain circumstances, may be unexpected or come late from the driver's point of view. So pay attention in order to intervene if necessary.

For example, the following traffic situations call for the utmost attention:

Starting driving after a stopping phase (only vehicles with automatic gearbox)

After a stopping phase, the ACC may begin driving automatically when the vehicle in front drives off » .

Overtaking

When the turn signal lights up before the vehicle begins an overtaking manoeuvre, the ACC accelerates the vehicle automatically and thus reduces the distance from the vehicle in front.

When the vehicle enters the overtaking lane, if the ACC does not detect another vehicle in front, it accelerates until it reaches the programmed speed and maintains it.

System acceleration can be interrupted at any time by pressing the brake or moving the third lever backwards » page 254.

Driving through a bend

On entering or exiting bends, the radar sensor may stop detecting the vehicle in front or reacting to a vehicle in the adjacent lane » **Fig. 215 A** In these situations the vehicle may brake unnecessarily or fail to react to the vehicle in front. In this case, the driver has to intervene by accelerating or interrupting the braking process by applying the brake or pushing the third lever backwards » page 254.

Driving in tunnels

When driving through tunnels the radar sensor may be limited. Switch off the ACC in tunnels.

Narrow or misaligned vehicles

The radar sensor can only detect narrow or misaligned vehicles when they are within range >>> **Fig. 215 B**. This applies particularly to narrow vehicles such as motorbikes. In these cases, you should brake as necessary.

Vehicles with special loads and accessories

Special loads and accessories of other vehicles that jut out over the sides, backwards or over the top may be out of the ACC's range.

Switch off the ACC when driving behind vehicles with special loads and accessories or when overtaking them. In these cases, you should brake as necessary.

Other vehicles changing lanes

Vehicles changing lanes a short distance away from your own can only be detected when they are within range of the sensors. Consequently, the ACC will take longer to react >>> **Fig. 216 C**. In these cases, you should brake as necessary.

Stationary vehicles

The ACC does not detect stationary objects while driving, such as traffic tails or damaged vehicles.

If a vehicle detected by the ACC turns or moves over and there is a stationary vehicle in front of it, the ACC will not react to it

>>> **Fig. 216 D**. In these cases, you should brake as necessary.

Vehicles driving in the opposite direction and vehicles crossing your path

The ACC does not react to vehicles approaching from the opposite direction or vehicles crossing your path.

Metal objects

Metal objects, e.g. rails on the road or sheets used in road works, can confuse the radar sensor and cause the ACC to react wrongly.

Factors that may affect how the radar sensor operates

If laser sensor operation is impaired, due to heavy rain, spray, snow or mud, the ACC is deactivated temporarily. The relevant text message will appear in the dash panel display. If necessary, clean the radar sensor >>> **Fig. 211 ①**.

When the radar sensor begins to operate properly again, the ACC will automatically be available again. The message on the instrument panel screen will switch off and the ACC will be reactivated again.

ACC operation may be affected by a strong radar reverse reflection, for example in a closed car park.

Trailer mode

When driving with trailer the ACC controls less dynamically.

Overheated brakes

If the brakes overheat, for example after abrupt braking or in long and steep slopes, the ACC may be deactivated temporarily. The relevant text message will appear in the dash panel display. In this case, adaptive cruise control cannot be activated.

Adaptive Cruise Control can be reactivated once brake temperature has cooled sufficiently. The message will disappear from the instrument panel display. If the message **ACC not available** remains on for quite a long time it means that there is a fault. Contact a specialised workshop. CUPRA recommends visiting a specialised CUPRA dealer or any SEAT dealership.

WARNING

If you do not heed the Press the brake message, the vehicle may initiate an involuntary movement and could crash into the vehicle ahead. In any event, before driving off, check that the road is clear. The radar sensor may not detect obstacles on the road. This could cause an accident and serious injuries. If necessary, apply the brake.

Lane Assist system*

Introduction

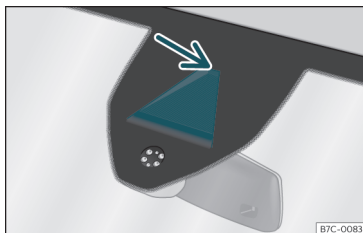

Fig. 217 On the windscreen: field of vision of the Lane Assist system camera.

Using the camera located in the windscreen, the Lane Assist system detects the possible lines dividing the lanes. When the vehicle involuntarily approaches a dividing line it has detected, the system notifies the driver with a *corrective steering movement*. The purpose is not only to warn the driver, but also to keep the vehicle inside the lane. This movement can be over-regulated at any time.

No warning is produced with the turn signals activated, given that the Lane Assist system understands that a lane change is required.

Control lamp

/!\ It lights up yellow

Lane Assist active but not available.
The system cannot accurately recognise the lane.
Please see page 262, Lane Assist system is not available (the control lamp is lit up yellow).

/!\ It lights up green

Lane Assist system active and available.

Some control and warning lamps will light up briefly when the ignition is switched on to check certain functions. They will switch off after a few seconds.

⚠ WARNING

Observe the safety warnings >>> **⚠** in Control and warning lamps on page 109.

Indications on the instrument panel display

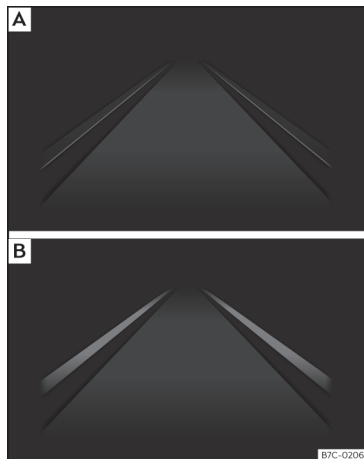

Fig. 218 On the instrument panel display: Indication on the Lane Assist system display (example 1).

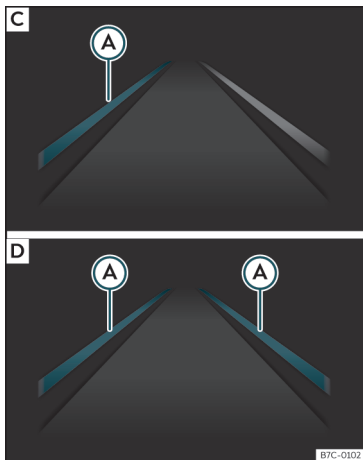

Fig. 219 On the instrument panel display: Indication on the Lane Assist system display (example 2).

Status display

- **Fig. 218 [A]:** The system is active, but not available, either because the minimum speed has not been reached or because the lane lines are not recognised.
- **Fig. 218 [B]:** The system is active and available, both lane lines are recognised. The steering angle is not being corrected at this moment.

- **Fig. 219 [C]:** The system is operational, the highlighted line (A) indicates that there was a risk of involuntarily crossing the lane line and that the steering is being adjusted to correct the angle.
- **Fig. 219 [D]:** The two highlighted lines (A) light up simultaneously when both lane lines are recognised and the Lane Assist function is activated.

Operating mode

Steering wheel vibration

The following situations can cause vibration in the steering wheel and require the driver to take active control of driving:

- When the steering angle assist value required to keep the vehicle in the lane is higher than the system's maximum operating value.
- If the system ceases to display the lane lines while assisting with steering.

Switching the Lane Assist system on or off

Through the Easy Connect system

- Press the Easy Connect button **CAR**
- Press the function button **SETTINGS** > **Driver assistance** to open the menu.

Or: Using the **Driving Assist** button on the turn signal lever* >>> page 109.

Lane Assist with lane centring guide

The **Lane Centring Guide** function is intended to keep the vehicle in the centre of the lane.

If the driver has a tendency to veer slightly off centre in the lane, the system adapts to driver preferences.

The **Lane Centring Guide** function is activated/deactivated in the Easy Connect system using the **CAR** button > **SETTINGS** function button >>> **page 33**.

Automatic deactivation: the Lane Assist system can be automatically deactivated if there is a system malfunction. The control lamp disappears.

Hands-Off Function

In the absence of steering wheel activity the system alerts the driver with acoustic signals and a text message on the dash panel asking to actively take over the steering.

If the driver does not react to this, the system also alerts the driver with a little shaking motion through the brakes and, if the vehicle has it, activates the Emergency Assist function >>> page 264. »

In vehicles without Emergency Assist, the adaptive lane guidance function will be disabled after the corresponding warnings to the driver.

The lane assist system is active but it is not available (the control lamp is lit up yellow)

- When driving at speeds below 65 km/h (38 mph).
- When the Lane Assist system does not detect the dividing lines of the road. For example, in the event warnings indicating road works, and snow, dirt, moisture or reflections.
- When the radius of a curve is too small.
- When no road markings can be seen.
- When the distance to the next marking is too great.
- When the system does not detect any clear and active steering movement during a long period of time.
- Temporarily, in the event of very dynamic driving styles.
- If a turn signal is activated.
- With the stability control system (ESC) in Sport mode or switched off.

BSD Plus (Lane Assist with Blind Spot Detector)*

The BSD Plus function is achieved by activating the Lane Assist and BSD functions

>>> page 265. In this case, the Lane Assist function expands its functions in the following way:

If the driver tries to change lane and there is a vehicle in the blind spot:

- The  lamp flashes in the corresponding rear-view mirror even though the turn signal has not been activated.
- The steering wheel vibrates to warn the driver of the risk of collision.
- torque is applied to correct the steering and return the vehicle to its lane.

Switching off the Lane Assist system in the following situations

Due to the limits of the Lane Assist system, switch it off in the following situations:

- When more attention is required of the driver
- When driving in a sporty style
- In unfavourable weather conditions
- On roads in poor condition
- In areas of road works

 **WARNING**

The intelligent technology in the Lane Assist system cannot change the limits imposed by the laws of physics and by the very nature of the system. Careless or uncontrolled use of the Lane Assist system may

cause accidents and injury. The system is not a replacement for driver awareness.

- Always adapt your speed and the distance to the vehicles ahead in line with visibility, weather conditions, the condition of the road and the traffic situation.
- Always keep your hands on the steering wheel so it can be turned at any time.
- The Lane Assist system does not detect all road markings. The road surfaces, road structures or objects in poor condition can be incorrectly detected as road markings under certain circumstances by the Lane Assist system. In such situations, switch the Lane Assist system off immediately.
- Please observe the indications on the instrument panel and act as is necessary.
- Always pay attention to the vehicle's surroundings.
- When the area of vision of the camera becomes dirty, covered or is damaged, the Lane Assist system function can be affected.

 **CAUTION**

In order to avoid influencing the operation of the system, the following points must be taken into account:

- Regularly clean the area of vision of the camera and keep it in a clean state, without snow or ice.

- Do not cover the area of vision of the camera.
- Check that the area of vision of the wind-screen camera is not damaged.

Note

- The lane departure warning system has been exclusively developed for driving on paved roads only.
- If the Lane Assist system does not work as described in this chapter, do not use it and contact a specialised workshop.
- Before starting a journey, verify that the field of vision of the camera is not covered >>> Fig. 217.
- Always keep the field of vision of the camera clean.
- If there is a fault in the system, have it checked by a specialised workshop.

Traffic Jam Assist

Description and operation

Traffic Jam Assist helps the driver keep the car within its lane and to move in convoy in case of traffic congestion or slow traffic.

Traffic Jam Assist is an additional function of Lane Assist >>> page 260 and combines Lane Assist functions with Adaptive Cruise Control

(ACC) >>> page 251. Therefore, it is essential that you read these two chapters carefully and note the limitations of the systems and the information about them.



Operation of Traffic Jam Assist

At speeds of below 60 km/h (40 mph), Traffic Jam Assist can maintain a (temporary) distance preset by the driver with respect to the vehicle ahead and help stay within the lane >>> .

To do this, the system automatically controls the accelerator, brakes and steering, and slows the vehicle, **stopping it fully if necessary**, when faced with a vehicle in front that has stopped. It automatically moves off again when the vehicle ahead moves.

Traffic Jam Assist is designed only for use on motorways and wide roads. Therefore, never use it in city traffic.

Technical requirements for using Traffic Jam Assist

- *Lane departure warning* must be activated: Infotainment button  > **SETTINGS** > **Driver assistance** > **Lane departure warning (Lane Assist)** function button >>>  page 33.
- *Adaptive lane guidance* must be activated: Infotainment button  > **SETTINGS** > **Driver assistance** > **Lane Assist** function button.

- Adaptive Cruise Control (ACC) must be connected and active >>> page 254.
- The speed must be below 60 km/h (38 mph).

Traffic Jam Assist is not active (the Lane Assist control light turns yellow)

- If any of the conditions mentioned on page 263, Technical requirements for using Traffic Jam Assist are no longer met.
- If any of the conditions required for operation of the Lane Assist are not met >>> page 260.
- If any of the conditions necessary for the adaptive cruise control (ACC) to work are no longer fulfilled >>> page 251.

Situations in which Traffic Jam Assist must be switched off

Due to the limitations of the system, Traffic Jam Assist must always be switched off in the following situations:

- When more attention is required by the driver.
- When driving in a very sporty style.
- In adverse weather conditions, e.g. in case of snow or heavy rain.
- When driving on roads in poor condition.
- In sections with roadworks.
- In city journeys.



⚠ WARNING

The smart technology incorporated into Traffic Jam Assist cannot defy the laws of physics; it only works within the limits of the system. Accidents and severe injury may occur if Traffic Jam Assist is used negligently or involuntarily. The system is not a replacement for driver awareness.

- Adapt your speed and safe distance to the vehicle in front of you at all times to suit the visibility, weather, road and traffic conditions.
- Do not use Traffic Jam Assist in city journeys.
- Do not use Traffic Jam Assist if there is poor visibility, for example, in case of snow, ice, rain or loose gravel, or on steep or slippery sections or flooded roads.
- Do not use Traffic Jam Assist offroad or on roads where the surface is not firm. Traffic Jam Assist has been designed for use on paved roads only.
- Traffic Jam Assist does not react to people or animals or vehicles crossing your path or that approach you head-on down the same lane.
- If Traffic Jam Assist does not reduce speed sufficiently, brake the vehicle immediately by applying the pedal.
- If the vehicle continues to move when you wish it to stop after a driver intervention prompt, brake the vehicle by applying the pedal.

- If *driver intervention is requested* on the dash panel display, immediately resume control of the vehicle.

- Keep your hands on the wheel at all times to be ready to intervene in the steering at any time. The driver is always responsible for keeping the vehicle in its own lane.
- Always be prepared to take charge of driving (accelerating or braking) yourself.

i Note

- If Traffic Jam Assist does not work as described in this chapter, stop using it and contact a specialised workshop.
- If the system is faulty, take it to a specialised workshop and have it checked.

Emergency Assist

Description and operation

Emergency Assist detects whether there is inactivity by the driver and can automatically keep the car within the lane and stop it altogether if necessary. This way the system can actively help avoid an accident.

Emergency Assist is an additional function of Lane Assist >>> page 260 and combines Lane Assist functions with Adaptive Cruise Control (ACC) >>> page 251. Therefore, it is essential

that you read these two chapters carefully and note the limitations of the systems and the information about them.

Operation of Emergency Assist

Emergency Assist detects when the driver ceases to perform any activity and repeatedly requests that he/she regain active control of the vehicle, through the use of optical and acoustic warnings and by applying the brakes.

If the driver continues to do nothing, the system automatically takes over the accelerator, brakes and steering in order to brake the vehicle and keep it in its lane >>> ⚠. When the Emergency Assist is actively adjusting, the hazard warning lights come on >>> page 136 and the vehicle makes slight zigzag movements in the lane in order to warn other drivers.

If the remaining braking distance is sufficient, if necessary the system slows down the vehicle **until it stops completely** and automatically switches on the electronic parking brake >>> page 219.

Switching the Emergency Assist on and off

The Emergency Assist is switched on automatically when the Lane Assist is switched on >>> page 260.

Technical requirements for using the Emergency Assist

- The adaptive cruise control (ACC) must be switched on >>> page 251.
- The Lane Assist must be switched on >>> page 260.
- The selector lever must be in the D/S position or in the Tiptronic selector gate.
- The system must have detected a lane separation line on both sides of the vehicle >>> Fig. 219.

The following conditions may cause the Emergency Assist not to react or to switch off automatically:

- If the driver accelerates, brakes or moves the steering wheel.
- If any of the conditions mentioned in >>> page 265, Technical requirements for using the Emergency Assist are not fulfilled.
- If any of the conditions required for operation of the Lane Assist are not met >>> page 260.
- If any of the conditions necessary for the adaptive cruise control (ACC) to work are no longer fulfilled >>> page 251.

WARNING

The smart technology incorporated into the Emergency Assist cannot overcome the limits imposed by the laws of physics; it only

works within the limits of the system. The driver is responsible for driving the vehicle.

- Adapt your speed and safe distance to the vehicle in front of you at all times to suit the visibility, weather, road and traffic conditions.
- Keep your hands on the wheel at all times to be ready to intervene in the steering at any time.
- The Emergency Assist alone cannot always avoid accidents or serious injuries.
- If the operation of the Emergency Assist is impaired, for example if the radar sensor of the adaptive cruise control (ACC) or the Lane Assist camera are covered or have lost their settings, the system may intervene inopportunely in braking or in steering.
- The Emergency Assist does not react to people or animal or vehicles crossing your path or which approach you head-on in the same lane.

WARNING

If the Emergency Assist Intervenes inopportunely, serious accidents and injuries may occur.

- If the Emergency Assist does not operate properly, switch off the Lane Assist >>> page 260. Doing so will also switch off the Emergency Assist.
- Have the system checked by a specialised workshop. To do so, CUPRA recommends

going to a specialised CUPRA dealer or any SEAT dealership.

Note

- Automatic interventions by the Emergency Assist on the brakes may be interrupted by pressing the accelerator or brake or by moving the wheel.
- Hazard warning lights that come on automatically can be switched off by pressing the accelerator or the brake, moving the steering wheel or pressing the hazard warning light switch.
- If this occurs, the Emergency Assist may decelerate the vehicle until it comes to a complete stop.
- When the Emergency Assist is activated, it is only available again after the ignition has been switched off and back on again.

Blind spot detector (BSD) with parking assistance (RCTA)*

Introduction

The blind spot detector (BSD) helps to detect the traffic situation behind the vehicle.

The integrated parking assistant (RCTA) helps the driver when backing out of a parallel parking spot and in manoeuvring. »

The blind spot detector has been developed for driving on paved roads.

WARNING

The smart technology incorporated into the blind spot detector (BSD) with parking assistance (RCTA) included cannot overcome the limits imposed by the laws of physics; it only works within the limits of the system. Accidents and severe injury may occur if the blind spot detection system or the rear cross traffic alert are used negligently or involuntarily. The system is not a replacement for driver awareness.

- Adapt your speed and safe distance to the vehicle in front of you at all times to suit visibility, weather, road and traffic conditions.
- Keep your hands on the wheel at all times to be ready to intervene in the steering at any time.
- Pay attention to the control lamps that may come on in the external rear view mirrors and on the instrument panel, and follow any instructions they may give.
- The blind spot assistant could react to any special constructions that might be present on the sides of the vehicle: e.g. high or irregular dividers. This may cause erroneous warnings.
- Never use the blind spot detector with rear cross traffic alert on unpaved roads. The blind spot detector with rear cross traf-

fic alert has been designed for use on paved roads.

- Always pay attention to the vehicle's surroundings.
- Never use the blind spot detector or the parking assistant if the radar sensors are dirty.
- The external rear view mirror control lamps may have limited functionality due to solar radiation.

CAUTION

- The radar sensors on the rear bumper may be damaged or shifted in the event of a collision, for example, when entering or exiting a parking space. This may result in the system disconnecting itself, or at least possibly having its functionality diminished.
- In order to ensure that the radar sensors work properly, keep the rear bumper free of snow and ice and do not cover it.
- The rear bumper should only be painted with paint authorised by CUPRA. The blind spot detector's functions may be limited or work incorrectly if other paints are used.

Note

If the blind spot detector with parking assistant does not work as described in this chapter, do not use it and contact a specialised workshop.

Control lamps

Control lamp in external rear view mirrors:

It lights up

It lights up once briefly: the blind spot detector is activated and ready to operate.

It lights up: blind spot detector has detected a vehicle in the blind spot.

Flashes

The blind spot detector has detected a vehicle in the blind spot and the turn signal has been turned on in the direction of the detected vehicle >>> .

For vehicles that are also equipped with Lane Assist >>> page 260, a warning to switch lanes will also appear even though the turn signal has not been engaged (blind spot detector "Plus").

Some warning and control lamps will light up briefly when the ignition is switched on to check certain functions. They will switch off after a few seconds.

If there are no indications from the control lamp in the external rear view mirror, this means that the blind spot detector has not detected any other vehicles in the area >>> .

If the dipped beam is on, then the control lamps in the external rear view mirrors will be dimmed (night mode).

⚠ WARNING

If the warning lamps and the corresponding messages are ignored when they light up, the vehicle may stall in traffic and cause accidents and severe injuries.

- Never ignore the warning lamps or messages.
- Carry out the necessary operations.

⚠ CAUTION

Failure to heed the control lamps and corresponding text messages when they light up may result in damage to the vehicle.

Blind spot detector (BSD)

Fig. 220 On external rear-view mirrors: blind spot detector display.



Fig. 221 Rear view of the vehicle: radar sensor areas.

The blind spot detector uses radar sensors to monitor the areas behind the vehicle »» **Fig. 221**. The system does this by measuring the vehicle's distance from other vehicles and its speed differential. The blind spot detector will not work at speeds of less than approx. 15 km/h (9 mph). The system uses optical signals in the external rear view mirrors to notify the driver.

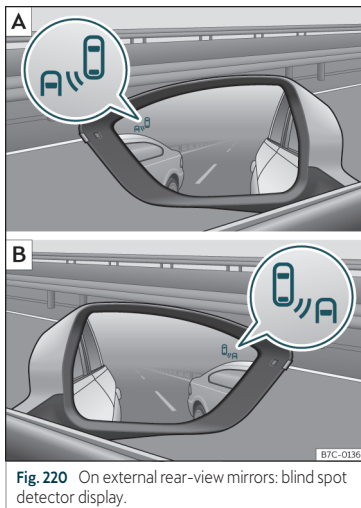
Indication in the external rear view mirrors

The control lamp (expanded view) provides an indication in the corresponding external mirror »» **Fig. 220** regarding the traffic situation behind the vehicle, if it is deemed to be critical. The control lamp of the left-hand external mirror indicates the traffic situation to the left of the vehicle, and the control »»

lamp of the right-hand external mirror indicates the traffic situation to the right of the vehicle.

In the case of retrofitted tinted windows or windows with tinted film, the indications of the external mirrors may not be seen clearly or correctly.

Keep the external mirrors clean and free of snow and ice, and do not cover them with adhesives or other similar materials.

Radar sensors

The radar sensors are located on the left and right of the bumper and are not visible from the outside »» Fig. 221. The sensors monitor both the blind spot and traffic behind the vehicle »» Fig. 222, »» Fig. 223. The range to the sides of the vehicle is a bit larger than the width of a lane.

The lane width is not detected individually, but is rather pre-configured in the system.

Thus if you are driving in wide lanes or in between two lanes, the indications may be incorrect. Furthermore, the system can detect vehicles driving in the lane next to you (if there are any), and can also detect stationary objects such as dividers, and thus give an incorrect indication.

Driving situations

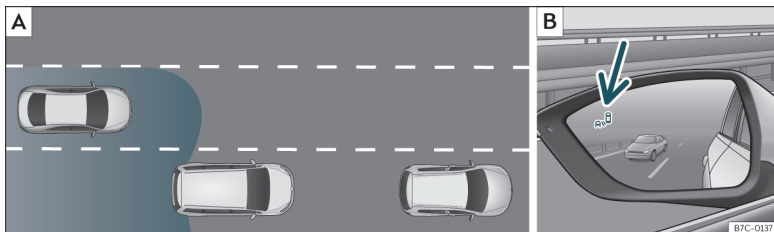

Fig. 222 Schematic diagram: [A] Passing situation with traffic behind the vehicle. [B] Indication from the blind spot detector in the left-hand external mirror.

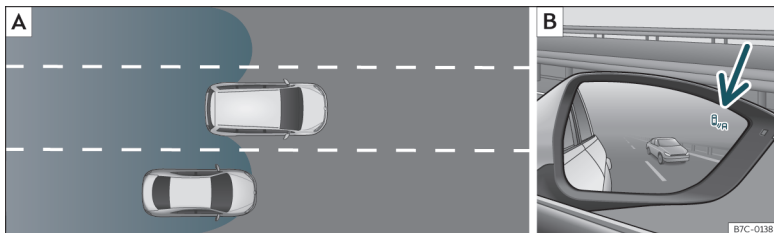

Fig. 223 Schematic diagram: [A] Situation of passing and then moving into the right-hand lane. [B] Indication from the blind spot detector in the right-hand external mirror.

In the following situations, an indication will be displayed in the external mirror
 >>> **Fig. 222** [B] (arrow) or >>> **Fig. 223** [B] (arrow):

- When being overtaken by another vehicle >>> **Fig. 222** [A].
- When passing another vehicle >>> **Fig. 223** [A] with a speed differential of approx. 10 km/h (6 mph). If the vehicle is passing at a

considerably higher speed, no indication will be displayed.

The faster the vehicle approaches, the sooner an indication will be displayed in the external mirror, because the blind spot detector takes into account the speed differential with other vehicles. Thus even though the distance from the other vehicle is identical, the indication will appear sooner in some cases and later in others.

Physical limitations inherent to the system

In some situations the blind spot detector may not interpret the traffic situation correctly. E.g. in the following situations:

- on tight bends;
- in the case of lanes with different widths;
- at the top of slopes;
- in adverse weather conditions;

>>

- in the case of special constructions to the side of the vehicle, e.g., high or irregular dividers.

Parking assistant (RCTA)



Fig. 224 Diagram of the parking assistant: detected area around the vehicle that is driving off.

The parking assistant uses the radar sensors on the rear bumper »» Fig. 221 to monitor the traffic crossing behind the vehicle as it backs out of a parallel parking space or as it is being manoeuvred, for example in very low visibility conditions.

If the system detects that someone else on the road is approaching the rear of the vehicle »» Fig. 224, an acoustic alarm is heard.

In addition to the acoustic alarm, the driver is also informed by means of a visual signal on infotainment system display. This signal is displayed in the form of a red strip at the back of the image of the vehicle on the infotainment system screen. This strip displays the side of the vehicle towards which traffic is approaching.¹⁾

Automatic braking to reduce damages

If the rear cross traffic alert detects that someone else on the road is approaching the rear of the vehicle and the driver does not step on the brake, the system will engage the brakes automatically.

The parking system helps the driver by automatically engaging the brakes to reduce any damage. The automatic intervention on the brakes takes place when driving in reverse at approx. 1-12 km/h (1-7 mph). After detecting that the vehicle is stationary, the system keeps it that way for around 2 seconds.

After automatically braking to reduce damage, the system will not be able to automatically brake again for approximately 10 seconds.

You can interrupt the automatic braking by stepping hard on the accelerator pedal or the brake pedal in order to regain control of the vehicle.

⚠ WARNING

The smart technology incorporated into the rear cross traffic alert cannot overcome the limits imposed by the laws of physics; it only works within the limits of the system. The parking assistant function should not tempt you into taking any risks. The system is not a replacement for driver awareness.

- The system should never be used in limited visibility conditions or complicated traffic, e.g., in high-traffic areas or when crossing multiple lanes.
- Be sure to always be aware of the vehicle's surroundings, since the system often fails to detect things such as bicycles or pedestrians.
- The rear cross traffic alert itself will not brake the vehicle to a complete stop.

¹⁾ It is only displayed if the vehicle is equipped with a parking system.

Using the blind spot detector (BSD) with parking assistant (RCTA)

Activating and deactivating the blind spot detector (BSD) with parking assistant (RCTA)

The blind spot detector with parking assistant can be switched on and off by accessing the **Assistance systems** menu on the dash panel display using the steering wheel controls. If the vehicle is equipped with a multi-function camera, it can also be accessed by means of the driver assistance systems key located on the main beam headlight lever.

Open the **Assistants** menu.

- Blind spot
- Exit Assist

If the verification box on the control panel is checked , the functionality will be automatically activated at ignition.

When the blind spot detector is ready to operate, the indications in the external mirrors will turn on briefly as confirmation.

When the vehicle is restarted, the last adjustment in the system will remain active.

If the blind spot detector was automatically deactivated, it will only be possible to restart the system after turning the vehicle off and restarting it.

Automatic deactivation of the blind spot detector (BSD)

The radar sensors of the blind spot detector with rear cross traffic alert will be automatically deactivated when, among other reasons, one of the sensors is detected to be permanently covered. This may be the case if, for example, there is a layer of snow or ice in front of one of the sensors.

The relevant text message will appear in the dash panel display.

Trailer mode

The Blind spot detector and the rear cross traffic alert will be automatically deactivated and it will be impossible to activate them if the tow hitch is electrically connected to a trailer or other similar object.

As soon as the driver starts to drive with a trailer connected electrically to the vehicle, a message will appear on the instrument panel display indicating that the blind spot detector and the rear cross traffic alert are deactivated. Once the trailer has been unhitched from the vehicle, if you want to use the blind spot detector and the rear cross traffic alert, you will have to reactivate them in the corresponding menu.

If the towing hitch is not factory equipped, then the blind spot detector and the rear cross traffic alert will have to be deactivated manually when driving with a trailer.

Drive Profile*

Introduction

The Drive Profile enables the driver to choose between six profiles or modes, **Comfort**, **Sport**, **Cupra**, **Individual**, **Offroad** and **Snow**, that modify the behaviour of various vehicle functions, providing different driving experiences.

The **Individual** profile can be configured according to personal preferences. The other profiles have a fixed configuration.

Description

Depending on the equipment fitted in the vehicle, the Drive Profile can operate on the following functions:

Engine

Depending on the profile selected, the engine responds more spontaneously or more in harmony with the movements of the accelerator.

The gear change points are modified to position them in lower or higher engine speed ranges. »

Address

The power steering varies its driving modes and adapts to the profile selected, thus offering the best behaviour for each situation.

Air conditioning

Climatronic can operate in eco mode, especially restricting fuel consumption.

Adaptive Cruise Control (ACC)

The acceleration and braking gradient of the adaptive cruise control varies according to the active driving profile »» page 251.

Electronic Stability Control (ESC)

In the **Offroad** and **Snow** driving profiles, the electronic stability Control (ESC) »» page 221 adjusts to adapt to the terrain.

In addition, hill descent control (HDC) is activated in the **Offroad** profile »» page 240.

Adjusting driving profile

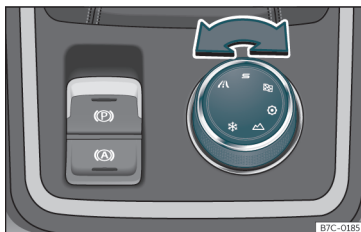

Fig. 225 Centre console: Driving Experience button.

You can choose from the **Comfort**, **Sport**, **Cupra**, **Individual**, **Offroad** and **Snow** profiles.

The desired mode can be selected as follows:

- Turn the Driving Experience button until the required profile lights up on the Easy Connect system display as well as on the Driving Experience button »» **Fig. 225**.
- **OR**: select the required profile on the touch-screen of the Easy Connect system, in the menu that opens up on turning the Driving Experience button.

The features of each profile can be seen by pressing the **Profile information** button of the Easy Connect system display.

In the **Individual** profile it is possible to configure the characteristics of the vehicle using the **Profile setup** button of the Easy Connect system display.

An icon on the Easy Connect system display provides information about the active profile if it is different than **Normal**. The selector identifies the profile chosen by means of a red LED light.

Driving profile	Characteristics
 Convenience	It permits more relaxed and comfortable driving, for example for long motorway journeys. Its main characteristic is the soft suspension setting (DCC).
 Sport	It represents the vehicle's default behaviour, suitable for dynamic driving.
 Cupra	It gives the vehicle a decidedly sportier nature, and makes for maximum performance.
 Individual	It allows you to personalise the configuration. The functions that can be adjusted depend on the equipment fitted in the vehicle.
 Offroad	It adjusts the vehicle's parameters in order to maintain optimal off-road driving.

Driving profile

Characteristics



Snow

It adjusts the vehicle's behaviour for driving on slippery road surfaces, optimising grip and manoeuvrability.

WARNING

When operating the Drive Profile, pay attention to all traffic: doing otherwise could cause an accident.

Note

- When the vehicle is switched off it will store the driving profile that was selected when the ignition key was removed. Nevertheless, when the engine is restarted, the engine and the gear will start by default in the Normal setting. For engine and gear to revert to the desired position, select the corresponding drive profile again by rotating the thumbwheel (Driving Experience Button) or selecting the profile on the Easy Connect display.
- When the vehicle is restarted after using the Offroad or Snow settings, the system is always activated in the Sport profile.
- Your speed and driving style must always be adjusted to visibility, weather, and traffic conditions.

Park Assist*

Introduction

The Park Assist system is an additional function of ParkPilot >>> page 283 and helps the driver to:

- find a suitable parking space,
- select a parking mode,
- park driving in reverse in suitable perpendicular and parallel spaces,
- park driving forwards in suitable perpendicular spaces,
- exit a parking space driving forwards from a parallel space.

In vehicles with a Park Assist system and factory infotainment system, the front, rear and side areas are represented, and the position of obstacles is shown relative to the vehicle.

The Park Assist system is subject to certain limitations inherent to the system and its use requires special attention by the driver >>> ⚠.

WARNING

The technology used in the park assist system involves a series of limitations inherent in the actual system and in the use of ultrasonic sensors. The use of Park Assist should never tempt you to take any risk that may

compromise safety. The system is not a replacement for driver awareness.

- Any accidental movement of the vehicle could result in serious injury.
- Adapt your speed and driving style at all times to suit visibility, weather, road and traffic conditions.
- Certain surfaces of objects and garments do not reflect the ultrasound sensors' signals. The system cannot detect, at least correctly, these objects or people wearing such clothes.
- Ultrasound sensor signals may be affected by external sound sources. In certain circumstances this may prevent them from detecting people or objects.
- The ultrasound sensors have blind spots in which obstacles and people are not registered.
- Monitor the area around the vehicle at all times, since the ultrasound sensors do not detect small children, animals or certain objects in all situations.

WARNING

Quick turns of the steering wheel when parking or exiting a parking space with Park Assist can cause serious injury.

- Do not hold the steering wheel during manoeuvres to park or exit a parking space »

until the system requests it. Doing so disables the system during the manoeuvre, resulting in the parking being cancelled.

ⓘ CAUTION

- In certain circumstances, the ultrasonic sensors do not detect objects such as trailer tongues, bars, fences, posts or thin trees, or an open (or opening) rear lid, which could damage the vehicle.
- Retrofitting of certain accessories to the vehicle, such as a bicycle rack, may interfere with the operation of the Park Assist system and cause damage.
- The Park Assist system uses as a reference parked vehicles, curbs and other objects. Make sure that the tyres and wheels are not damaged while parking. If necessary, opportunely interrupt the parking manoeuvre to avoid damaging the vehicle.
- The ultrasound sensors on the bumper may be damaged or shifted in the event of a collision, for example, when entering or exiting a parking space.
- If you use high-pressure or vapour equipment to clean the ultrasound sensors, do not apply it directly unless very briefly and always from a distance of more than 10 cm.
- A registration plate or plate holder on the front with larger than the space for the registration plate, or a registration plate that is curved or warped can cause:
 - false detections,

- loss of sensor visibility.
- cancellation of the parking manoeuvre or defective parking.

- If one of the ultrasonic sensors is damaged, the area corresponding to that group of sensors (front or rear) is deactivated and cannot be activated until the fault is corrected. However, you can still use the sensors of the other bumper as per usual. If there is a fault in the system, consult a specialist workshop. To do so, CUPRA recommends going to a specialised CUPRA dealer or any SEAT dealership.

ⓘ Note

- In order to guarantee good system operation, keep the ultrasound sensors of the bumper clean, free of snow or ice, and do not cover them with adhesives or other objects.
- Certain sources of noise, such as rough asphalt or paving stones and the noise of other vehicles can induce the Park Assist system or ParkPilot to give erroneous warnings.
- To become familiar with the system and its functions, CUPRA recommends that you practice operating the Park Assist system in an area where there is not too much traffic or in a car park.

Description of the Park Assist system

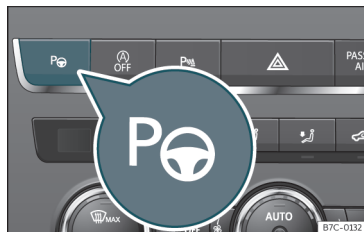

Fig. 226 In the centre console, top section: button to switch on the Park Assist system.

The components of the Park Assist system are the ultrasonic sensors located in the front and rear bumpers, the P@ button >>> **Fig. 226** to switch the system on and off and the messages on the instrument panel display.

Prematurely stopping or automatically interrupting the manoeuvres for parking or exiting a parking space

Park Assist interrupts the manoeuvres for parking or exiting a parking space in any of the following cases:

- Press the P@ button.
- The speed exceeds approximately 7 km/h (4 mph).
- The driver takes hold of the steering wheel.

- The parking manoeuvre does not end within 6 minutes from the activation of automatic steering.
- There is a fault in the system (the system is temporarily unavailable).
- ASR is switched off.
- ASR or ESC intervene with regulation.
- The driver door is opened.

To restart the manoeuvre it is necessary that none of these things occur and that the **P** button is pressed again.

Special characteristics

The Park Assist system is subject to certain limitations inherent to the system. For example, it is therefore not possible to enter or exit a parking space on sharp bends.

While entering or exiting a parking space, a brief signal sounds to prompt the driver to change between forward and reverse gears (depending on the case). In successive manoeuvres, the assistant tells the driver to change gears, at the latest, when the continuous audible signal is given (object present at a distance of ≤ 30 cm) by Park Pilot.

When the Park Assist system turns the steering wheel with the vehicle stationary, the instrument panel also displays the symbol . Keep the brake pedal depressed while the symbol remains on the dash panel display to turn the wheels with the vehicle stopped. This way, the system will require fewer manoeuvres to complete the parking action.

Trailer mode

The Park Assist system cannot be switched on if the factory-fitted towing bracket **>>> page 296** is electrically connected to a trailer.

After changing a wheel

If, after changing a wheel, the vehicle stops entering and exiting parking spaces correctly, the circumference of the new wheel may be different and the system may need to adapt to it. The adaptation is automatic and takes place during driving. Making turns slowly and in both directions (20 km/h [12 mph]) for a few minutes may contribute to this adaptation process **>>>  in Introduction on page 273.**

Selecting a parking mode

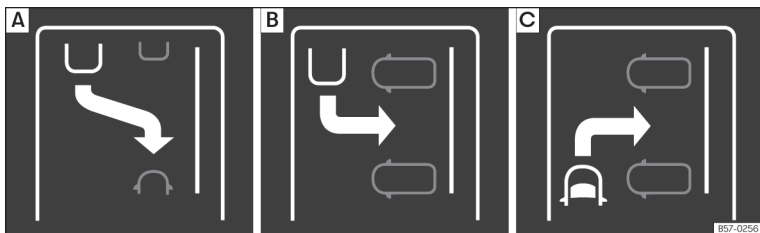

Fig. 227 Overview of reduced displays for parking modes: **A**) Parallel parking in reverse. **B**) Perpendicular parking in reverse. **C**) Perpendicular parking forwards.

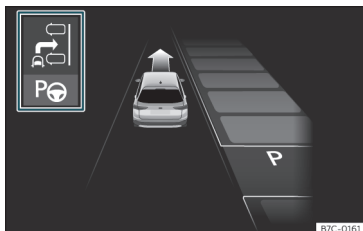

Fig. 228 On the instrument panel display: display of the assisted parking system with decreased visibility.

Selecting a parking mode with Park Assist with prior step in front of the space

After activating the Park Assist system and after detecting a parking space, the display on the instrument panel proposes a parking mode. The Park Assist system selects the parking mode automatically. The selected

mode is shown on the instrument panel display »» Fig. 228. The reduced display of other possible parking modes is also shown »» Fig. 227. If the mode selected by the system does not correspond to the desired mode by pressing the **P** button »» Fig. 226.

	Action
1.	The necessary conditions to park with Park Assist have to be met »» page 278.
	Press the P button.
2.	A control lamp on the P button lights up when the system is switched on. Additionally, the selected parking mode is shown on the instrument panel display and the reduced display shows another parking mode it can be changed to.

	Action
3.	Turn on the corresponding turn signal towards the side of the road where you are parking. The instrument panel displays the side corresponding to the road. By default, if the turn signal is not on, it parks on the right in the direction of traffic.
4.	If necessary, press the P button again to change to the next parking mode. Once you have switched to all possible parking modes, if the P button is pressed again, the system switches off.
5.	Press the P button again to switch the system back on.
6.	Follow the instructions displayed on the instrument panel while paying attention to traffic and drive the vehicle past the parking space.

Special case of perpendicular parking space to park forwards without driving past first

	Action
1.	The necessary conditions to park with Park Assist have to be met »» page 278.

	Action
2.	Drive forward towards the parking space while paying attention to traffic and stop the vehicle.

	Action
	Press the P button once.
3.	A control lamp on the P button lights up when the system is switched on. Additionally, the selected parking mode is shown on the instrument panel display without reduced display.
4.	Release the steering wheel »»  in Introduction on page 273.

Park with Park Assist

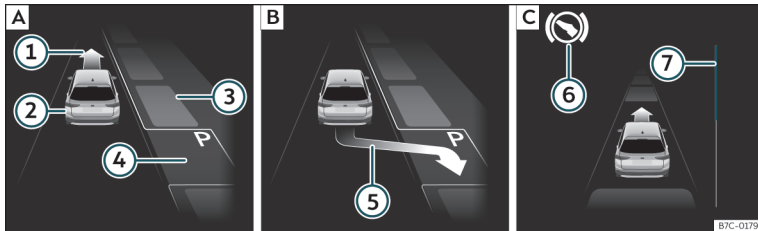

Fig. 229 On the instrument panel display: perpendicular parking. **[A]** Finding a parking space. **[B]** Parking position. **[C]** Manoeuvring.

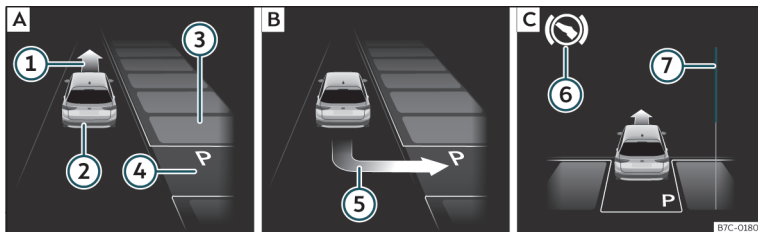

Fig. 230 On the instrument panel display: parallel parking. **[A]** Finding a parking space. **[B]** Parking position. **[C]** Manoeuvring.

Key to **Fig. 229** and **Fig. 230**:

- ① Message to move forwards
- ② Your vehicle
- ③ Parked vehicle
- ④ Parking space detected
- ⑤ Message to park
- ⑥ Message to press the brake pedal
- ⑦ Progress bar

Progress bars

The progress bar
 >>> **Fig. 229** ⑦ and >>> **Fig. 230** ⑦ on the screen of the instrument panel displays the relative distance to be covered. The greater the distance, the fuller the progress bar. When driving forward, the content of the progress bar decreases upwards, and when reversing, it decreases downwards.

Necessary conditions to park with Park Assist

For parallel parking spaces

For perpendicular parking spaces

The traction control system (ASR) must be turned on
 >>> page 223.

For parallel parking spaces	For perpendicular parking spaces
Do not exceed approximately 40 km/h (25 mph) when driving past the parking space.	Do not exceed approximately 20 km/h (12 mph) when driving past the parking space.
Keep a distance between 0.5 and 2.0 metres when driving past the parking space.	
Length of the space: length of the vehicle + 0.8 metres	Width of the space: width of the vehicle + 0.8 metres
Do not exceed approximately 7 km/h (4 mph) when parking.	

Parking

	Do the following:
1.	The necessary conditions have to be met to park with Park Assist >>> page 278 and the parking mode must be selected >>> page 276.
2.	Look at the display on the instrument panel to see if the space has been detected as "appropriate" and if the correct position for parking has been reached >>> Fig. 229 [B] or >>> Fig. 230 [B] . The space is considered "appropriate" if the display on the instrument panel shows the message to park (5) .
3.	Stop the vehicle and, after a brief pause, engage the reverse gear.
4.	Release the steering wheel >>> (Δ) in Introduction on page 273.

	Do the following:
5.	Please note the following message: Automatic steering enabled. Pay attention to your surroundings. While you keep watch around you, carefully start accelerating up to no more than 7 km/h (4 mph). During the parking manoeuvre, the system only takes charge of the steering. You, as the driver, have to accelerate, engage the clutch if necessary, change gears and brake.
6.	Reverse until the ParkPilot continuous signal is heard. OR: reverse until the instrument panel displays the message to go forwards >>> Fig. 229 [C] or >>> Fig. 230 [C] . OR: reverse until the instrument panel displays the message Park Assist finished . The progress bar (7) indicates the distance to cover >>> page 278.
7.	Press down the brake pedal until the Park Assist system has finished turning the steering wheel. OR: until the (S) symbol on the instrument panel display switches off.
8.	Select first gear.

	Do the following:
9.	Go forward until the ParkPilot continuous signal is heard. OR: go forward until the instrument panel display shows the message to reverse. The Park Assist system steers the vehicle forward and back until it centres it in the space >>> Fig. 229 [C] or >>> Fig. 230 [C] .
10.	For best results, wait at the end of each manoeuvre until the Park Assist system has finished turning the steering wheel. The parking manoeuvre ends when a corresponding message is displayed on the instrument panel and, in some cases, an acoustic signal sounds.

(i) Note

If the manoeuvre is terminated prematurely during parking, the result may not be the best.

Exiting a parking space with Park Assist (only for parallel spaces)

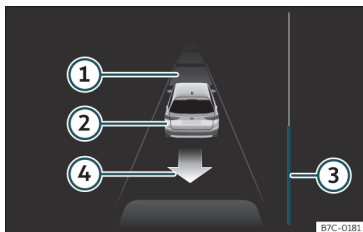

Fig. 231 On the instrument panel display: driving off from perpendicular parking.

Key to the **Fig. 231**:

- ① Parked vehicle
- ② Your vehicle in reverse gear
- ③ Progress bar to indicate the distance left to cover
- ④ Message giving the proposed manoeuvre to exit the parking space

Necessary conditions to exit a parking space with Park Assist

- Only for parallel parking spaces
- The traction control system (ASR) must be turned on »» page 223.
- Length of the space: **length of the vehicle + 0.5 metres**

- Do not exceed approximately **7 km/h (4 mph)** when exiting the parking space.

Exiting a parking space

Do the following:

For parallel parking spaces	
1.	The necessary conditions to exit a parking space with Park Assist have to be met »» page 280.
2.	Switch on the engine »» page 214.
	Press the P button »» Fig. 226 .
3.	A control lamp on the P button lights up when the system is switched on.
4.	Turn on the corresponding turn signal towards the road you will enter when exiting the parking space.
5.	Engage reverse gear or turn the selector lever to position R .

For parallel parking spaces	
	Release the steering wheel »» △ in Introduction on page 273.
	Please note the following message: Automatic steering enabled. Pay attention to your surroundings.
6.	While you keep watch around you, carefully start accelerating up to no more than 7 km/h (4 mph).
	When exiting the parking space, the system only takes charge of the steering. You, as the driver, have to accelerate, engage the clutch if necessary, change gears and brake.
	Reverse until the ParkPilot continuous signal is heard.
7.	OR: go backwards until the instrument panel display shows the message to go forward.
	The progress bar »» Fig. 231 ③ indicates the distance to cover »» page 278.
	Press down the brake pedal until the Park Assist system has finished turning the steering wheel.
8.	OR: press down the brake pedal until the S symbol on the instrument panel display switches off.
	Go forward until the ParkPilot continuous signal is heard.
9.	OR: go forward until the instrument panel display shows the message to reverse.
	The Park Assist system steers the vehicle forward and back until it can exit the space.

For parallel parking spaces	
10.	The vehicle can exit the space when a corresponding message is displayed on the instrument panel and, in some cases, an acoustic signal sounds. Take charge of the steering with the turning angle set by the Park Assist system.
11.	Paying attention to the traffic, exit the parking space.

Automatic braking intervention by Park Assist

Park Assist helps the driver by automatically braking in certain situations.

The driver is always responsible for braking in time >>> .

Automatic braking intervention to avoid exceeding the speed limit

To avoid exceeding the allowed speed of approx. 7 km/h (4 mph) when entering or leaving a parking space, the brakes may activate automatically. After automatically activating the brakes, the manoeuvres to enter or exit a parking space may continue.

The brakes are only automatically activated once for each attempt to enter or exit a parking space. If the speed of approximately

7 km/h (4 mph) is exceeded again, the corresponding operation is halted.

Automatic braking to reduce damages

Depending on certain conditions, the Park Assist system can automatically brake the vehicle when faced with an obstacle, briefly actuating and holding down the brake pedal >>> . Following this the driver must press the brake pedal.

Automatic braking intervention to reduce damage leads to the parking manoeuvre finishing.

WARNING

The automatic braking intervention by Park Assist should never tempt you to take any risk that may compromise safety. The system is not a replacement for driver awareness.

- The Park Assist system is subject to certain limitations inherent to the system. In certain situations, the automatic braking intervention may only work in a limited way or not work at all.
- Always be ready to use the brakes yourself!
- The automatic braking intervention will end after approximately 1.5 seconds. Afterwards, brake the vehicle yourself.

Parking aid parking and manoeuvring (ParkPilot)

Introduction

Assorted assistance systems – which vary depending on the equipment fitted in the car – will help you when parking or manoeuvring:

- **Parking System Plus.** It assists the driver by visually and audibly warning them about obstacles detected in *front* and *behind* the vehicle >>> page 283.
- **Rear parking aid.** It is an audible and visual assistant that warns about obstacles located *behind* the vehicle >>> page 287.

WARNING

- Always pay attention, also when looking straight ahead, to traffic and the vehicle surroundings. The assistance systems are not a replacement for driver awareness. When inserting or removing the vehicle from a parking space, or when performing similar manoeuvres the driver always assumes the responsibility.
- Adapt your speed and driving style at all times to suit visibility, weather, road and traffic conditions.
- The ultrasound sensors have blind spots in which obstacles and people are not registered. Pay special attention to children and animals.

»

- Always keep visual control of the surroundings: use the mirrors for additional help.

ⓘ CAUTION

Parking Aid functions may be negatively affected by different factors that may lead to damage to the vehicle or its immediate surroundings:

- Under certain circumstances, the system does not detect or display certain objects:
 - Objects such as chains, trailer draw bars, fences, posts and thin trees.
 - Objects that are located above the sensors, such as protrusions in a wall.
 - Objects with certain surfaces or structures, such as wire mesh fences or powder snow.
- Certain surfaces of objects and garments do not reflect the ultrasound sensors' signals. The system cannot detect these objects or people wearing such clothes correctly.
- Ultrasound sensor signals may be affected by external sound sources. In certain circumstances this may prevent them from detecting people or objects.
- Please note that low obstacles detected by the system may no longer be registered by the sensors as the car moves closer, so the system will not give any further warning. In certain circumstances, objects such

as high kerbs that could damage the bottom of the vehicle are not detected either.

- If the first warning from the Parking Aid is ignored, the vehicle could suffer considerable damage.
- The knocks or damage on the radiator grille, bumper, wheel arch and vehicle underbody can adjust the orientation of the sensors. This can affect the parking aid function. In this case, have the function checked by a specialised workshop.
- A registration plate or plate holder on the front with larger than the space for the registration plate, or a registration plate that is curved or warped can cause:
 - false detections,
 - loss of sensor visibility.

ⓘ Note

- In certain situations, the system can give a warning even though there is no obstacle in the detected area, e.g:
 - with rough or cobbled floors or ground with long grass;
 - with external ultrasound sources, such as cleaning vehicles or other vehicles equipped with ultrasound systems;
 - in downpours, intense snow, hail or dense exhaust gases,
 - if the number plate is not perfectly secured to the bumper surface,
 - or in locations such as the brow of a hill.

- In order to guarantee good system operation, keep the ultrasound sensors clean, free of snow or ice, and do not cover them with adhesives or other objects.
- If you use high-pressure or vapour equipment to clean the ultrasound sensors, apply it directly only very briefly and always from a distance of more than 10 cm.
- Retrofitting of accessories to the vehicle, such as a bicycle rack, may interfere with the operation of the Parking Aid.
- Fitting certain accessories to the front of the vehicle, such as a plate holder with advertising, may interfere with the operation of the Park Assist.
- In order to familiarise yourself with the system, it is advised that you practice parking in an area or car park that is free from traffic. There must be good weather and light conditions.
- The volume and tone of the warnings can be modified, in addition to the indications >>> page 289.
- In vehicles *without* an infotainment system, these parameters can be modified in a specialised CUPRA Service or SEAT Official Service or in a specialised workshop.
- Please observe information on towing a trailer >>> page 289.
- The display on the Easy Connect screen shows a slight time delay.

Parking System Plus*

Description

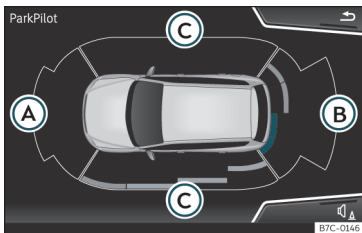

Fig. 232 Represented area.

During parking, **Parking System Plus** assists the driver by visually and audibly warning them about obstacles detected *in front of* and *behind* the vehicle.

There are ultrasound sensors integrated in the front and rear bumpers. When they detect an obstacle, you are alerted by audible warnings and visually on the Easy Connect system.

In case of risk of rear or front collision, an audible warning will be emitted. You can tell whether the risk is in front of or behind the vehicle by choosing different sound frequencies on Easy Connect.

Make particularly sure that the sensors are not covered by adhesives, residues and the

like, as this could affect the system's operation. Cleaning instructions >>> page 335.

The approximate measurement range of the sensors is:

- Ⓐ 1.20 m
- Ⓑ 1.60 m
- Ⓒ 0.90 m

As you approach the obstacle, the time interval between the audible warnings will be reduced. When you reach around 0.30 m the warning will be constant: do not continue to move forward (or backward)!

If you maintain separation from the obstacle, the volume of the warning begins to reduce after four seconds (does not affect the tone of the constant warning).

In order to view the entire periphery of the vehicle, the vehicle must be moved a few metres forwards or backwards. Thus, the missing areas are screened and obstacles at the sides of the vehicle are displayed >>> Fig. 232 Ⓒ.

Special features of ParkPilot with Area View

In the following situations the screened area on the side of the vehicle is automatically hidden:

- When a vehicle door is opened.

- When the ASR is switched off.
- When there is ASR or ESC regulation.
- If the vehicle remains stationary for more than approximately 3 minutes.

Parking Aid operation

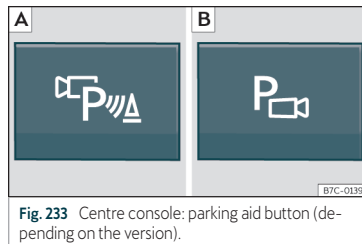

Fig. 233 Centre console: parking aid button (depending on the version).

Manual connection of Parking Aid

- Press the **P** button *once*.

Manual disconnection of Parking Aid

- Press the **P** button *again*.

Manual disconnection of Parking Aid display (the audible sounds remain active)

- Press a button on the main menu of the factory-assembled infotainment system.
- **OR** press the **BACK** function button. »

Automatic connection of Parking Aid

- Engage reverse gear or turn the selector lever to position **R**.
- OR:** If the vehicle approaches an obstacle that is in its forwards path at a speed below 15 km/h (9 mph) >>> page 284. The obstacle is detected from a distance of approx. 95 cm if the automatic connection is activated in the infotainment system. A reduced display is shown.
- OR:** if the vehicle moves backwards.

Automatic disconnection of Parking Aid

- Move the selector lever to position **P**.
- OR:** accelerate to approx. 15 km/h (9 mph) or faster.

Temporary suppression of sound in Parking Aid

- Press the  function button.

Change from reduced view to full view

- Engage reverse gear or turn the selector lever to position **R**.
- OR:** press the car icon in reduced view.

If necessary, switch to the rear-assist image (Rear View Camera "RVC")

- Engage reverse gear or turn the selector lever to position **R**.
- OR** press the **RVC** function button.

A short confirmation signal will be heard and the button symbol will light up yellow when the system is switched on.

Automatic activation

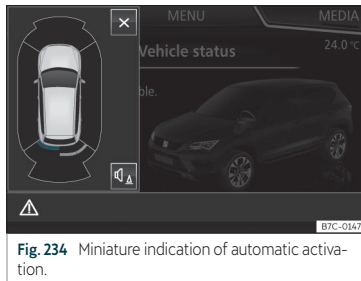



Fig. 234 Miniature indication of automatic activation.

When the **Plus Parking Aid** connects automatically, a miniature of the vehicle and the segments will appear on the left of the display >>> **Fig. 234**.

Automatic activation occurs when slowly approaching an obstacle located in front of the vehicle. It only operates every time the speed is reduced below approximately 15 km/h (9 mph) for the first time.

If the parking aid is switched off using the **PWA** button, the following actions must be carried out in order for it to automatically switch on:

- Switch off the ignition and switch it on again.
- OR:** accelerate above 15 km/h (9 mph) before reducing speed below this number again.
- OR:** place the selector lever in position **P** and then move it from this position.
- OR:** switch on and off the automatic activation in the Easy Connect system menu.

The automatic activation with parking aid miniature indication can be switched on and off from the Easy Connect system menu >>>  page 33:

- Switch the ignition on.
- Select: Infotainment button  **SETTINGS** > **Parking and manoeuvring** function button.
- Select the **Automatic activation** option. When the function button check box is activated , the function is on.

If the system has been activated automatically, an audible sound warning will only be given when obstacles in front are at a distance of less than 50 cm.

CAUTION

The automatic connection of the Parking Aid only works when you are driving slowly.

If driving style is not adapted to the circumstances, an accident and serious injury or damage may be caused.

Segments of the visual indication

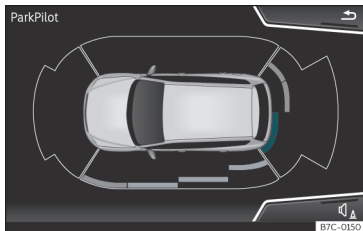

Fig. 235 Parking Aid display on the Easy Connect system screen.

The distance of separation from the obstacle can be estimated using the segments around the vehicle.

The optical indication of the segments works as follows:

White segments: they are displayed when the obstacle 30 cm away from the vehicle or further if it is not within the vehicle's trajectory or the direction of travel is in the opposite direction to its location, and also when the electronic parking brake is activated.

Yellow segments: obstacles located in the vehicle's trajectory and which are more than 30 cm away from the vehicle are displayed in yellow.

Red segments: obstacles that are less than 30 cm away from the vehicle are displayed in red.

Moreover, a yellow trail indicates the vehicle's expected trajectory based on the steering wheel angle.

Whenever the obstacle is located in the vehicle's direction of travel, the corresponding audible warning will sound.

As the vehicle approaches an obstacle, the segments are displayed closer to the vehicle. When the penultimate segment is displayed, this means that the vehicle has reached the collision zone. In the collision zone, the obstacles are represented in red, including those out of the path. Do not continue to move forward (or backward) >>> [△](#) in Introduction on page 281, >>> [!](#) in Introduction on page 282 !

In the event the car is equipped with the Top View Camera system, Park Assist visual guidance will appear in accordance with the view selected in the Top View Camera system.

Adjusting the display and audible warnings

The settings for the display and audible warnings are controlled via the Easy Connect*.

Automatic activation

on – activates the **Automatic activation** option >>> page 284.

off – deactivates the **Automatic activation** option >>> page 284.

Front volume*

Volume in the front and rear area.

Front sound settings/sharpness*

Frequency (tone) of the sound in the front area.

Rear volume*

Volume in the rear area.

Rear sound settings/sharpness*

Frequency (tone) of the sound in the rear area.

Adjust volume





With the parking aid switched on, the active audio/video source volume will be reduced to the intensity of the selected setting.

Error messages

When the Parking Aid is activated or when it is switched on, if a message reporting a Parking aid error is displayed on the instrument panel, there is a fault in the system.

If the fault does not disappear before disconnecting the ignition, the next time that the parking aid is engaged in reverse, no audible signal of the existence of a fault will be issued.

If there is a fault in the parking aid system a message will appear on the instrument panel indicating the error.

If there is a fault in a sensor, the symbol  is displayed on the Easy Connect display in front of/behind the vehicle. If a rear sensor is faulty, only the obstacles in area  are displayed  **Fig. 232**. If a front sensor is faulty, only the obstacles in area  are displayed.

Have the fault corrected by a specialised workshop without delay.

Driving with a trailer

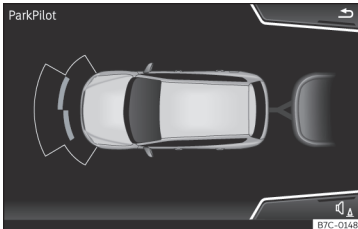

Fig. 236 Parking assist display on the screen with trailer attached.

In vehicles equipped with a towing bracket device from the factory, when the trailer is connected electrically, the Parking Aid rear sensors will not be activated when reverse gear is engaged, when the selector lever is turned to position **R** or when the button **P^{wa}** is pressed.

The distance to possible obstacles at the rear of the vehicle and at its sides will not be displayed on the screen and will not be indicated by means of audible sound signals.

The Easy Connect system screen will only display objects detected at the front, and the vehicle's trajectory will be hidden.

Braking while manoeuvring function*

✓ Only valid with Parking System Plus

The emergency braking function is used to minimise damage in the event of a collision.

Depending on the equipment, if the Parking Aid is active, the braking while manoeuvring function activates emergency braking when it detects an obstacle in the vehicle's path that could cause a collision, driving forwards or in reverse.

The function will not brake if the Parking Aid is activated automatically. For the system to operate, manoeuvring speed must be between 2.5 and 10 km/h (between 1.5 and 6 mph) for the front area and between 1.5 and 10 km/h (between 1 and 6 mph) for the rear.

Following an intervention, the braking while manoeuvring function will be inactive in the same direction of travel for 5 metres. Once the gear is changed, or the selector lever's position is changed, the function will be active again. The Parking Aid's limitations apply.

The braking while manoeuvring function is controlled in the Easy Connect system with the  button and the **SETTINGS > Park and manoeuvre** function buttons.

- **on** – permits the use of the braking while manoeuvring function.

- **off** – does not permit the use of the braking while manoeuvring function.

Temporary suppression of emergency braking

- When the function is deactivated with the **Braking while manoeuvring** button that appears on the **Parking System** screen of the Easy Connect system.
- Whenever any of the car doors, rear lid or bonnet are opened.

Rear parking aid*

Description

The **rear parking aid** is an audible and visual assistant that warns of obstacles located *behind* the vehicle.

There are sensors integrated in the rear bumper. When they detect an obstacle, you are alerted by audible warnings and visually on the Easy Connect system.

If the Top View Camera* is installed, the rear parking aid will issue an audible warning about objects near the rear of the vehicle, and the Top View Camera* image will be available on the Easy Connect screen, giving a real image of the objects around the car.

Make particularly sure that the sensors are not covered by adhesives, residues, dirt and the like, as this could affect the system's operation. Cleaning instructions >>> page 335.

The approximate measurement range of the rear sensors is:

Side area: 0.60 m

Central area: 1.60 m

Automatic disconnection of Parking Aid



- Move the selector lever to position **P**.
- **OR**: accelerate to approx. 15 km/h (9 mph) or faster.

Temporary suppression of sound in Parking Aid

- Press the  function button.

Change from reduced view to full view

- Engage reverse gear or turn the selector lever to position **R**.
- **OR**: press the car icon in reduced view.

As you approach the obstacle, the time interval between the audible warnings will be reduced. When you reach around 0.30 m the warning will be constant: Do not continue to move forward (or backward) >>>  in Introduction on page 281, >>>  in Introduction on page 282!

If you maintain separation from the obstacle, the volume of the warning begins to reduce after four seconds (does not affect the tone of the constant warning).

Parking Aid operation

Parking Aid connection

- Move the selector lever to the **R** position.

Parking Aid disconnection

- Position the selector lever in **P**, **N** or **D**.

Set the lever to the **N** or **D** position to maintain the system active for approximately 8 seconds before switching off. During that time, Parking assist will switch off if:

- The selector lever is moved to position **P**.
- **OR**: the vehicle accelerates to approx. 15 km/h (9 mph) or faster.

If the Top View Camera* is installed, rear parking aid will be automatically deactivated when disengaging reverse gear.

Manual disconnection of Parking Aid display (the audible sounds remain active)

- Press a button on the main menu of the factory-assembled infotainment system.
- **OR** press the **BACK** function button.



Temporary suppression of sound in Parking Aid

- Press the  function button. If you have the Top View Camera* system installed, you cannot use the temporary suppression of sound in Parking Aid.

Switch from reduced to full-screen view if the rear assist is fitted (Rear View Camera “RVC”)

- Press the car icon in the reduced view.

If necessary, switch to the rear-assist image (Rear View Camera “RVC”)

- Engage reverse gear or turn the selector lever to position R.
- **OR:** press the RVC function button.

Segments of the visual indication

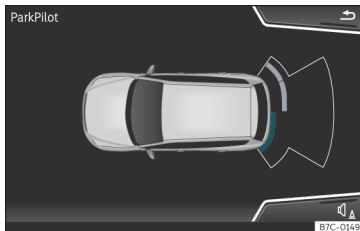

Fig. 237 Parking Aid display on the Easy Connect system screen.

The distance to the obstacles can be estimated with the help of the segments at the rear of the vehicle.



The optical indication of the segments works as follows:

White segments: they are displayed when the obstacle 30 cm away from the vehicle or further if the direction of travel is in the opposite direction to its location, and also when the electronic parking brake is activated.

Yellow segments: obstacles located in the vehicle's trajectory and which are more than 30 cm away from the vehicle are displayed in yellow.

Red segments: obstacles that are less than 30 cm away from the vehicle are displayed in red.

Whenever the obstacle is located in the vehicle's direction of travel, the corresponding audible warning will sound.

As the vehicle approaches an obstacle, the segments are displayed closer to the vehicle. When the penultimate segment is displayed, this means that the vehicle has reached the collision zone. In the collision zone, the obstacles are represented in red (including those out of the path). Do not continue to reverse **>>>**  in Introduction on page 281, **>>>**  in Introduction on page 282!

If you are equipped with the Top View Camera*

Segments are not displayed when the vehicle is equipped with Top View Camera*.

The Parking Aid system will issue an audible warning for objects that are near the rear of the vehicle, and the Top View Camera* image will be available on the screen, giving a real image of the objects around the car.

Adjusting the display and audible warnings

The settings for the display and audible warnings are controlled via the Easy Connect*.

Rear volume*

Volume in the rear area.

Rear sound settings/sharpness*

Frequency (tone) of the sound in the rear area.

Adjust volume

With the parking aid switched on, the active audio/video source volume will be reduced to the intensity of the selected setting.

Error messages

When the Parking Aid is activated or when it is switched on, if a message reporting a Parking aid error is displayed on the instrument panel, there is a fault in the system.

If the fault disappears before disconnecting the ignition, the next time that the parking aid is engaged in reverse, no audible signal of the existence of a fault will be issued.

If there is a fault in a sensor, the  symbol is displayed on the Easy Connect display.

Have the fault corrected by a specialised workshop without delay.

Towing bracket

In vehicles equipped with a towing bracket device from the factory, when the trailer is connected electrically, the Parking Aid will not be activated, even when the selector lever is placed in the **R** position.

Top View Camera*

Introduction

Using 4 cameras, the system generates a representation that is shown on the infotainment system display. The cameras are located on the radiator grille, the exterior mirrors and the rear lid.

The functions and representations of the Area View system may vary depending on whether or not the vehicle has ParkPilot.

WARNING

The image from the cameras does not make it possible to calculate the distance to the obstacles (people, vehicles, etc.) pre-

cisely, so using them could cause serious accidents and injury.

- The camera lenses augment and distort the visual field and the objects on the screen are seen differently and imprecisely.
- Certain objects may not be shown or may not be shown very clearly, for example, posts or thin rails, due to the screen resolution or if light conditions are insufficient.
- The cameras have blind spots in which obstacles and people are not registered.
- The camera lens must be kept free, without snow or ice, and should not be covered.

WARNING

The smart technology incorporated into the Top View Camera* system cannot overcome the limits imposed by the laws of physics and it only works within the limits of the system. The greater convenience provided by the Area View system should never tempt you to take any risk that may compromise safety. If used negligently or involuntarily, it may cause serious accidents and injuries. The system is not a replacement for driver awareness.

- Adapt your speed and driving style to suit visibility, weather, road and traffic conditions.
- Do not be distracted from the traffic by looking at the screen.



- Monitor the area around the vehicle at all times, since the cameras do not capture small children, animals and certain objects in all situations.
- The use of a number plate may interfere in the views shown on the screen, since the cameras' field of vision may be reduced.
- The system will probably be unable to represent all areas clearly.

ⓘ CAUTION

- The camera images are only two-dimensional. Due to a lack of spatial depth, objects that jut out or holes on the road, for example, are more difficult to detect or may not be seen at all.
- In certain circumstances, the camera does not capture objects such as beams, fences, posts or thin trees, which could damage the vehicle.
- The system displays the auxiliary lines and boxes regardless of the vehicle's environment, no objects are detected. The driver is responsible for determining that the vehicle will fit in the parking space.

ⓘ CAUTION

In order to guarantee good system operation, keep the cameras clean, free of snow or ice, and do not cover them with adhesives or other objects.

- Never use abrasive cleaning products to clean the camera lenses.
- Do not use hot or warm water to remove ice or snow from the camera lenses. Doing so could damage the lenses.

Area View system

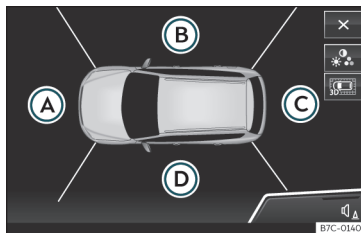

Fig. 238 Display of the Area View system: aerial view.

There are four different views to choose from:

Key to the Fig. 238:

Symbol	Meaning
(A)	Front camera area
(B)	Right camera area
(C)	Rear camera area

Key to the Fig. 238:

Symbol	Meaning
(D)	Left camera area
X	Exit the current display.
3D icon	Three-dimensional views
Speaker icon	Depending on the equipment: connecting and disconnecting the ParkPilot sound.
Settings icon	Adjust the display: bright, contrast and colour.

The aerial view is generated by combining the images from all the cameras >>> **Fig. 238**. The aerial view can be selected by pressing the *vehicle* in the area.

Select the corresponding view by pressing the different areas >>> **Fig. 238** (A) to (D) of the aerial view or the reduced aerial view.

Conditions necessary for the use of the Area View system

- The doors and the rear lid must be closed.
- The image must be reliable and clear. For this reason, for example, the camera lens must be clean.
- The area around the vehicle must be clear-ly and totally visible.
- The area for parking or manoeuvring should be a flat surface.

- The vehicle should **not** be loaded very heavily at the rear.
- The driver must be used to the system.
- There should be no damage to the vehicle in the camera area. If the position or installation angle of the cameras have been changed, e.g. after a rear-end collision, the system should be checked by a specialised workshop.

Camera image view

- **Aerial view (bird's eye view):** to obtain a panoramic view of the vehicle (📷), three-dimensional views, from different camera positions.
- **Front camera (front view):** to observe traffic ahead of the vehicle (vehicles crossing) 🚗, for front parallel parking 🚗🅐, when approaching an obstacle and in off-road driving 🚗.
- **Side cameras (side view):** to view the area close to the sides of the vehicle, both on the left 📷 and on the right 📷, or a combination of both sides 📷.
- **Rear camera (rear view):** To observe traffic behind the vehicle (vehicles crossing) 🚗, for reverse perpendicular parking 🚗🅒, for reverse parallel parking 🚗🅑🅒 and for hitching a trailer to the vehicle 🚗🅒.

The selected view is displayed on the right side of the screen. The reduced aerial view

shown on the right side displays the view framed in yellow. In addition, the right margin of the screen displays the menu options possible and the views (the so-called "modes") of the camera in question. The active view (mode) at the time is highlighted.

The reduced aerial view can be hidden by pressing the \llcorner symbol to thus display the selected view full-screen.

Instructions for use

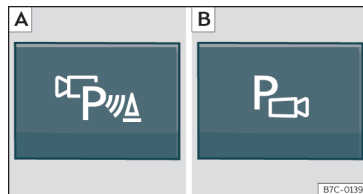

Fig. 239 Centre console: button for activating/deactivating the Area View system manually in combination with the parking aid system (A) or else with the rear ParkPilot system (B).

Connecting and disconnecting the Area View system

Manual connection of the display:	Press the P button \ggg Fig. 239 once. The infotainment system screen displays the aerial view \ggg Fig. 238 . If you press the P button when driving above 15 km/h (9 mph), the image will not be displayed.
Automatic connection of the display:	Engage reverse gear. OR: The vehicle moves backwards. The view of the image of the vehicle's rear camera is shown in parallel parking mode with the reduced aerial view.
Manual disconnection of the display:	Press the P button \ggg Fig. 239 again. OR: press a button on the factory-equipped infotainment system, for example the (RADIO) button. OR: press the (X) function button.
Automatic disconnection of the display:	Drive forwards at over 15 km/h (9 mph) approximately. OR: switch off the ignition. The Area View system menu disappears immediately.

\ggg

Special characteristics

Examples of optical illusions caused by the cameras:

The images on the area view system cameras are only two-dimensional. Due to a lack of spatial depth, it is difficult or impossible to make out on-screen any holes there may be on the ground, objects jutting out from the ground or parts protruding from other vehicles.

Situations in which the objects or other vehicles appear to be further away or closer than they really are:

- On moving from a horizontal plane to a slope.
- On moving from a slope to a horizontal plane.
- If the vehicle is heavily loaded at the rear.
- If the vehicle approaches protruding objects. These objects may be outside the cameras' angle of visibility.

Trailer mode

The Area View system conceals, in the rear camera area, all the auxiliary guiding lines when the factory-fitted towing bracket is connected electrically to a trailer
»» page 296.

Note

To become familiar with the system and its functions, CUPRA recommends that you practice handling the Area View system in an area where there is not too much traffic or in a car park.

Top View Camera system menus (modes)

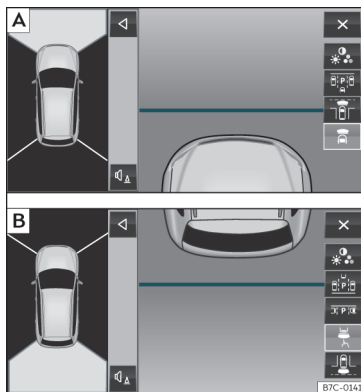

Fig. 240 Display on the Area View system screen: [A] Front camera: off-road view. [B] Rear camera: off-road view.

Key to the Fig. 240:

Symbol	Meaning
	Depending on the equipment: connecting and disconnecting the ParkPilot sound.
	Showing the reduced display.
	Hiding the reduced display.

Key to the Fig. 240:



Symbol	Meaning
	Exiting the Area View system screen:
	Adjust the display: bright, contrast and colour.

Aerial views (bird's eye view)

View	On-screen display of all cameras
Main mode 	The vehicle and its immediate vicinity seen from above are shown. Depending on the equipment, the ParkPilot's path may also be displayed.
Three-dimensional views	The vehicle and its vicinity seen from above are shown.
	The vehicle and its vicinity seen from above are shown obliquely.
	The vehicle and its vicinity seen obliquely are shown.



Swipe the infotainment system display with your finger in the direction of the arrows to change the angle of vision in the three-dimensional views of the vehicle and its vicinity.

Front camera views (front view)



View	On-screen display of the front camera
Cross traffic at the front 	Left side of the screen: perpendicular street to the left.
	Middle of the screen: area directly in front of the vehicle.
	Right side of the screen: perpendicular street to the right.
Parallel parking 	The area in front of the vehicle is shown. Orientation lines are shown to give guidance.
Off-road 	The area directly in front of the vehicle seen from above is shown. For example, on a slope, in order to see the area directly in front of the vehicle. The red line is shown at a distance of approx. 0.4 m away from the vehicle.



Side camera views (side view)

View	On-screen display of the side cameras
Right and left sides 	The areas located directly to the side of the vehicle seen from above are represented in order to navigate possible obstacles more precisely. The orange auxiliary lines are shown at a distance of approx. 0.4 away from the vehicle

View	On-screen display of the side cameras
Left side 	The area directly next to the vehicle, on the driver's or front passenger's side, is displayed, and the blind spots all along the vehicle can be seen. The auxiliary orange line is shown at a distance of approx. 0.4 m away from the vehicle.
Right side 	

Rear camera views (rear view)

View	On-screen display of the rear camera
Parallel parking 	The area behind the vehicle is shown. Auxiliary lines are shown to give guidance.
Perpendicular parking 	The vehicle's initial position on initiating this function will be a decisive factor in determining the place where the manoeuvre executed by the assistant will end.

View	On-screen display of the rear camera
Off-road or hitching a trailer function 	The vehicle's rear is presented. The red auxiliary line establishes the safety distance.
	Green and red semicircular auxiliary lines are displayed in vehicles with a factory-fitted towing bracket. The auxiliary lines indicate the distance from the towing bracket. The distance between the auxiliary (green and red) lines is approximately 0.3 m. The orange auxiliary line indicates, depending on the turn of the steering wheel, the pre-calculated direction of the towing bracket.
	In vehicles with a factory-fitted towing bracket, the distance from the red auxiliary line to the vehicle is approx. 0.4 m. No other lines are shown.
Cross traffic at the rear 	Left side of the screen: perpendicular street to the left.
	Middle of the screen: area directly behind the vehicle.
	Right side of the screen: perpendicular street to the right.

Rear Assist (Rear View Camera)*

Operating and safety warnings

⚠ WARNING

- The Rear Assist does not make it possible to precisely calculate the distance from obstacles (people, vehicles, etc.) and nor can it overcome the system's own limits, hence using it may cause serious accidents and injuries if used negligently or without due care. The driver should be aware of his/her surroundings at all times to ensure safe driving.
- The camera lens expands and distorts the field of vision and displays the objects on the screen in a different, vague manner. The perception of distances is also distorted by this effect.
- Due to the screen resolution or insufficient light conditions, some items may be displayed in an unsatisfactory manner or not at all. Take special care with thin posts, fences, railings or trees that might not be displayed on screen and could damage the vehicle.
- The rear assist has blind spots where it is not possible to represent people or objects (small children, animals and certain objects cannot be detected in its field of vision). Monitor the vehicle's surrounding area at all times.

- Keep the camera lens clean, free of ice and snow, and do not cover it.
- The system is not a replacement for driver awareness. Supervise the parking operation at all times, as well as the vehicle's surrounding area. Adapt your speed and driving style at all times to suit visibility, weather, road and traffic conditions.
- Do not be distracted from the traffic by looking at the screen.
- The images on the rear assist screen are only two-dimensional. Due to a lack of spatial depth, protruding parts or holes in the road, for example, are more difficult to detect or may not be seen at all.
- Vehicle load modifies the representation of the orientation lines displayed. The width represented by the lines diminishes with vehicle load. Pay special attention to the vehicle's surroundings when the inside of the vehicle of the luggage compartment is carrying a heavy load.
- In the following situations, the objects or other vehicles shown in the navigation system display appear to be further away or closer than they really are: Pay special attention:
 - On moving from a horizontal plane to a slope.
 - On moving from a slope to a horizontal plane.
 - If the vehicle is heavily loaded at the rear.

- When the vehicle approaches objects that are not on the ground surface or are jutting out from it. These objects may also be outside the camera's angle of vision when reversing.

i Note

- It is important to take great care and pay special attention if you are not yet familiar with the system.
- Rear assist will not be available if the vehicle's rear lid is open.

Instructions for use

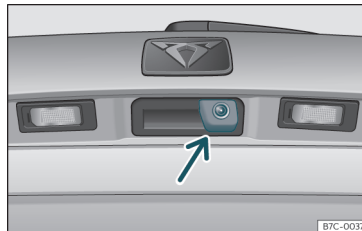

Fig. 241 On the rear lid handle: location of the rear assist camera.

A camera installed in the rear lid handle assists the driver in reverse parking or manoeuvring >>> **Fig. 241**. The camera image is viewed together with orientation lines

projected by the system on the Easy Connect system screen. The bottom of the screen displays part of the bumper corresponding to the number plate area that will be used as reference by the driver.

Rear assist settings

Rear assist offers the user the possibility to change the image's *brightness, contrast and colour* settings.

To change these settings:

- Park the vehicle in a safe place.
- Apply the parking brake.
- Switch the ignition on.
- If necessary, switch on the Easy Connect system.
- Engage reverse gear or turn the selector lever to position **R**.
- Press the $\ast\%$ function button displayed on the right of the image.
- Make the desired adjustments on the menu by pressing the $-/+$ function buttons or by moving the corresponding scroll button.

Necessary conditions for parking and manoeuvring with the rear assist

The system should not be used in the following cases:

- If the image displayed is not very reliable or is distorted, for example low visibility or dirty lens.
- If the area behind the vehicle is not displayed very clearly or is incomplete.
- If the vehicle is heavily loaded at the rear.
- If the position and installation angle of the camera have been changed, e.g. after a rear-end collision. Have the system checked by a specialised workshop.

Familiarising yourself with the system

To familiarise yourself with the system, the orientation lines and their function, CUPRA recommends practising parking and manoeuvring with the rear assist in a place without too much traffic or in a car park when there are good weather and visibility conditions.

Cleaning the camera lens

Keep the camera lens clean and clear of snow and ice:

- Moisten the lens using a normal alcohol-based glass cleaning product and clean the lens with a dry cloth.
- Remove snow using a small brush.
- Use de-icing spray to remove any ice.

ⓘ CAUTION

- Never use abrasive cleaning products to clean the camera lens.
- Do not use hot or warm water to remove ice or snow from the camera lens. Doing so could damage the camera.

Parking and manoeuvring with the rear assist

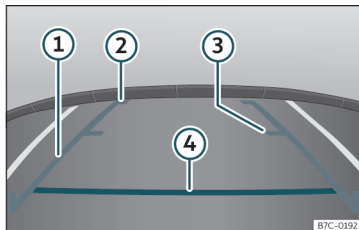

Fig. 242 Display on the Easy Connect system screen: guidance lines.

Switching the system on and off

- The rear assist will switch on when the ignition is on or the engine running and the selector lever is changed to the **R** position.
- The system disconnects 8 seconds after removing the selector lever from the **R** position. The system will also disconnect immediately after switching off the ignition. »

- The camera will stop transmitting images above the speed of 15 km/h (9 mph) with reverse engaged.

In combination with the Parking System Plus >>> page 283, the camera image will cease to be transmitted immediately when reverse gear is disengaged or when the selector lever is moved from the **R** position, and the optical information provided by the Parking Aid system will be displayed.

Also in combination with the system, the rear assist image can also be concealed:

- By pressing one of the Infotainment system buttons on the display.
- OR: by pressing the miniature vehicle that appears on the left of the screen (which switches to the full-screen mode of the Parking System Plus's optical system).

If you wish to display the rear assist image again:

- Disengage reverse, or change the selector lever's position, engage reverse again or move the selector lever to position **R**.
- OR: Press the **RVC** function button¹⁾

¹⁾ WARNING: the **RVC** function button will only be activated and available when the selector lever is set to position **R**.

Meaning of the orientation lines

>>> Fig. 242

- ① **Side lines:** extension of the vehicle (the approximate width of the vehicle plus the rear view mirrors) on the road surface.
- ② **End of the side lines:** the area marked in green ends approximately 2 m behind the vehicle on the road surface.
- ③ **Mid line:** indicates a distance of approximately 1 m behind the vehicle on the road surface.
- ④ **Horizontal red line:** indicates a safe distance of approximately 40 cm at the rear of the vehicle on the road surface.

Parking manoeuvre

- Stop the vehicle in front of a parking space and place the selector lever in the **R** position.
- Reverse slowly, and turn the steering wheel so that the side orientation lines lead towards the parking space.
- Guide the vehicle into the parking space so that the side orientation lines run parallel to it.

Towing bracket device*

Trailer mode

Introduction

Take into account country-specific regulations about driving with a trailer and the use of a towing bracket.

The vehicle has been developed primarily for carrying people, although it can also be used to tow a trailer if fitted with the corresponding technical equipment. This additional load has an effect on the useful life, fuel consumption and vehicle performance and in some cases can reduce the service intervals.

Driving with a trailer requires more force from the vehicle, and thus more concentration from the driver.

In winter, winter tyres should be fitted on both the vehicle **and** the trailer.

Maximum vertical load technically permissible on the coupling

The *maximum* vertical load technically permitted from the trailer draw bar on the towing bracket's tow hitch is **80 kg**.

Vehicles with the Start-Stop system

If the vehicle has a factory-fitted towing bracket or one that is retrofitted by CUPRA, the Start-Stop system operates as normal. No special characteristics need to be taken into account.

If the system does not recognise the trailer or the trailer bracket has not been retrofitted by CUPRA, the Start-Stop system must be disconnected by pressing the corresponding button in the lower part of the centre console before driving with the trailer, and it should remain off for the rest of the journey >>> .

Vehicles with driving profile selection

If you are going to be towing a trailer, the use of the **Eco** driving profile is not recommended. You are advised to select another of the available driving profiles before beginning to drive with a trailer.

WARNING

Never use the trailer to transport people, since it would put their life in danger and is also prohibited.

WARNING

Undue use of the towing bracket may cause injury and accidents.

- Only use the towing bracket if it is in a perfect state of repair and is properly secured.
- Never modify or repair the towing bracket in any way.
- In order to reduce the danger of injury in the event of rear-end collisions and to avoid injury to pedestrians and cyclists when parking the vehicle, cover or remove the tow hitch when you are not using a trailer.
- Never fit a towing bracket “with weight distribution” or “load compensation”. The vehicle has not been designed for this type of towing bracket. The towing bracket could fail and the trailer could be released from the vehicle.

WARNING

Driving with a trailer and transporting heavy or large objects can affect driving properties and even cause an accident.

- Always secure the load properly using belts or straps that are suitable and in good condition.
- Adapt your speed and driving style at all times to suit visibility, weather, road and traffic conditions.
- Trailers with a high centre of gravity are more likely to overturn than those with a low one.
- Avoid sudden braking and manoeuvres.

- Take great care when overtaking.
- Reduce speed immediately if you notice that the trailer is swaying, however slightly.
- Never drive at more than 80 km/h (50 mph) when towing a trailer (or at more than 100 km/h (60 mph) in exceptional circumstances). This also applies in countries where driving at higher speeds is permitted. Take into account the speed limit for vehicles with trailers in the corresponding country, as it could be less than the speed limit for vehicles without a trailer.
- Never attempt to “straighten” the towing vehicle and trailer while accelerating.

WARNING

If the towing bracket has been retrofitted by a non-CUPRA workshop, the Start-Stop system must be disconnected manually whenever driving with a trailer. Otherwise the brake system could be damaged and could consequently cause a serious accident or injury.

- Always disconnect the Start-Stop system manually when using a towing bracket that has not been fitted by a CUPRA workshop.

Note

- Before hitching or unhitching a trailer, always deactivate the anti-theft alarm >>> page 112. Otherwise, the tilt sensor could cause the alarm to go off.



- Do not drive with a trailer for the engine's first 1000 km »» page 232.
- CUPRA recommends that, if possible, the tow hitch be disassembled or covered when it is not going to be used. In the event of a rear-end collision, the damage to the vehicle could be greater if the bracket is fitted.
- Some retrofitted towing brackets cover the rear towing eye. In these cases, the towing eye should not be used for tow-starting or for towing other vehicles. For this reason, if the vehicle has been retrofitted with a towing bracket, always keep the tow hitch in the vehicle when you disassemble it.

Control lamp

Lamp on button lights up

The tow hitch is not securely locked in position. Check that the towing bracket is locked »» page 299.

Some warning and control lamps will light up briefly when the ignition is switched on to check certain functions. They will switch off after a few seconds.

WARNING

If the warning lamps and the corresponding messages are ignored when they light up, the vehicle may stall in traffic and cause accidents and severe injuries.

- Never ignore the warning lamps or messages.
- Stop the vehicle at the next opportunity and in a safe place.

CAUTION

Failure to heed the control lamps and corresponding text messages when they light up may result in damage to the vehicle.

Technical requirements

Vehicles that are **factory**-equipped with a towing bracket fulfil all the technical and legal requirements for driving with a trailer.

If the **vehicle is retrofitted** with a towing bracket, only a bracket that is authorised for the maximum authorised load of the trailer that is to be towed may be fitted. The towing bracket must be suitable for the vehicle and the trailer and must be properly secured to the vehicle's chassis. Only use a towing bracket that has been authorised by CUPRA for this vehicle. Always check and take into account the towing bracket manufacturer's instructions. Never fit a towing bracket "with weight distribution" or "load compensation".

Towing bracket fitted on the bumper

Never fit a towing bracket to the bumper or to the area where the bumper is mounted.

The towing bracket should not impair the bumper's function. Do not make modifications or repairs to the exhaust system or the brake system. Make regular checks to ensure that the towing bracket is secure.

Engine cooling system

Driving with a trailer increases the load on the engine and cooling system. The cooling system should have sufficient coolant and be prepared for the additional effort involved in driving with a trailer.

Trailer brakes

If the trailer has its own brake system, please take the relevant legal requirements into account. Never connect the trailer's brake system to the vehicle's brake system.

Tow rope

Always use a cable between the vehicle and the trailer »» page 301.

Trailer rear lights

The trailer's rear lights should comply with the statutory safety regulations »» page 301.

Never connect the trailer's rear lights directly to the vehicle's electric system. If you are not sure that the trailer's electrical connection is correct, have it checked by a specialised workshop. To do so, CUPRA recommends

going to a specialised CUPRA dealer or any SEAT dealership.

Exterior mirrors

If you cannot see the area behind the trailer with the exterior mirrors of the towing vehicle, additional mirrors will have to be installed in accordance with the regulations of the country in question. The exterior mirrors should be adjusted before you start driving and must provide a sufficient field of vision at the rear.

Trailer maximum electricity consumption

Consumers	Europe, Asia, Africa, South America and Central America	Australia
Brake lights (total)	84 Watts	108 Watts
Turn signal (on each side)	42 Watts	54 Watts
Side lights (on each side)	50 Watts	100 Watts
Reverse lights (in total)	42 Watts	54 Watts
Rear fog light	42 Watts	54 Watts

Never exceed the values indicated!

⚠ WARNING

If the towing bracket is wrongly fitted or is not the right one, the trailer could become detached from the vehicle and cause serious injury.

ⓘ CAUTION

- If the rear lights of the trailer are not correctly connected, the vehicle's electronic system may be damaged.
- If the trailer absorbs excessive electric current, the vehicle's electronic system may be damaged.
- Never connect the trailer's electric system directly to the electrical connections of the tail lights or any other power sources. Only use the connections intended for providing electric current to the trailer.

Electrical unlocking tow hitch

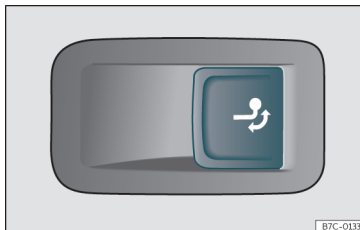

Fig. 243 Right side of the boot: button to unlock the tow hitch.

The tow hitch is located in the bumper. The electrical unlocking tow hitch cannot be disassembled.

There should be no person, animal or object in the path of the tow hitch »» ⚠.

Unlock the tow hitch and remove it

- Stop the vehicle and connect the electronic parking brake »» page 217.
- Switch off the engine.
- Open the rear lid.
- Pull the »» Fig. 243 button briefly. The tow hitch unlocks electrically and automatically turns outwards. The control lamp in the button will flash »» Fig. 243.

»

- Remove the tow hitch with your hand until you feel and see that it has engaged and the control lamp on the button stays on.
- Close the rear lid.

Cover the tow hitch

- Stop the vehicle and apply the electronic parking brake.
- Switch off the engine.
- Unhook the trailer and interrupt the electrical connection between it and the vehicle. If you are using an adapter, remove it from the trailer's power socket.
- Open the rear lid.
- Pull the >>> Fig. 243 button briefly. The tow hitch unlocks electrically.
- Turn the tow hitch under the bumper with your hand until you feel and see that it engages and the control lamp on the >>> Fig. 243 button stays on.
- Close the rear lid.

Meaning of control lamp

- If the warning light of the button >>> Fig. 243 is *flashing*, this means that the tow hitch has not been attached properly or is damaged >>> .
- If the warning lamp *stays on* with the rear lid open, the tow hitch is correctly in place both when engaged and when covered.

- The control light of the lamp switches off approximately 1 minute after closing the read lid.

WARNING

Undue use of the towing bracket may cause injury and accidents.

- Only use the tow hitch if it is properly engaged.
- Always ensure that no person, animal or object is to be found in the path of the tow hitch.
- Never use a tool or instrument while the tow hitch is moving.
- Never press the >>> Fig. 243 button when there is a trailer hooked to the vehicle or when a carrier system or other accessories are mounted on the tow hitch.
- If the tow hitch is not attached properly, do not use it. Instead, go to a specialised workshop and have the towing bracket checked.
- If you detect any fault in the electrical system or in the towing bracket, contact a specialised workshop and ask them to check it.
- If the ball has a diameter of less than 49 mm at any one point, do not use the towing bracket under any circumstances.

CAUTION

If you clean the vehicle with high-pressure or steam devices, do not point the jet directly towards the retractable tow hitch or the trailer power socket, as this may damage the joints or remove the grease necessary for lubrication.

Note

At extremely low temperatures, the tow hitch may be impossible to use. In this case, place the vehicle in a warmer location (for example, a garage).

Fitting a bicycle carrier on the retractable tow hitch

The maximum allowed weight of the carrier system, including the load, is **75 kg**. The carrier system should not protrude more than 700 mm backwards from the spherical head. Only carrier systems on which up to 3 bikes can be mounted are allowed. Heavier bicycles must be mounted as close to the vehicle as possible (tow hitch).

WARNING

The incorrect use of the tow hitch with a bicycle rack mounted on the tow hitch can cause accidents and injury.

- Never exceed the maximum weight or the limits indicated above.
- The bicycle rack may not be mounted to the neck of the hitch below the ball because, due to the shape of the neck and depending on the rack model, the rack could be incorrectly mounted on the vehicle.
- Always read and take the manufacturer assembly instructions into account.

ⓘ CAUTION

If the maximum weight and limits indicated above are exceeded, the vehicle may suffer considerable damage.

- Never exceed the values indicated!

ⓘ Note

CUPRA recommends removing, as far as possible, all removable parts of the bicycles before setting off. These parts include, for example, baskets and saddlebags, child seats or batteries. This improves aerodynamics and the centre of gravity of the rack system.

Hooking up and connecting a trailer

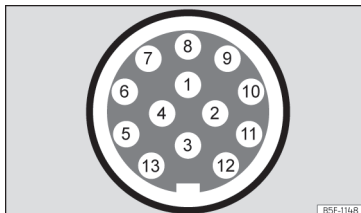

Fig. 244 Diagram: assignment of the pins of the trailer's electrical socket.

Key to the Fig. 244:

Pin	Meaning
1	Left turn signal
2	Rear fog light
3	Earth for pins 1, 2, 4, 5, 6, 7 and 8
4	Right turn signal
5	Rear light, right
6	Brake lights
7	Rear light, left
8	Reverse lights
9	Permanent live
10	Live charge cable

Key to the Fig. 244:

Pin	Meaning
11	Earth for pin 10
12	Unassigned
13	Earth for pin 9

Trailer power socket

The vehicle is fitted with a 13-pole power socket for the electrical connection between the trailer and the vehicle. With the engine running, electrical devices on the trailer receive power from the electrical connection (pin 9 and pin 10 of the trailer power socket).

If the system detects that a trailer has been connected electrically, the electrical equipment on the trailer will receive voltage through this connection (pins 9 and 10). Pin 9 has a permanent live. This powers, for example, the trailer's interior lighting. Electrical devices such as a fridge in a caravan **only** receive electrical power if the engine is running (through pin 10).

To avoid overloading the electrical system, you cannot connect the ground wires of pin 3, pin 11 or pin 13.

If the trailer has a **7-contact connector**, you will need to use an adapter cable. In this case the function corresponding to pin 10 will not be available. »

Tow rope

The tow rope must always be securely fixed to the towing vehicle and loose enough so that the vehicle can handle turns smoothly. However, make sure that the cable does not rub on the ground while driving.

Trailer rear lights

Always check the trailer's rear lights to ensure they are working correctly and that they comply with the relevant safety regulations. Make sure that the maximum permissible power that can be absorbed by the trailer is not exceeded » page 299.

Connection to the anti-theft system

The trailer is included in the anti-theft system if the following conditions are met:

- If the vehicle is factory-equipped with an anti-theft alarm and towing bracket.
- If the trailer is electrically connected to the towing vehicle through the trailer power socket.
- If the electrical systems of the vehicle and trailer are in perfect condition and have no faults or damage.
- If the vehicle is locked with the key and the anti-theft alarm is activated.

When the vehicle is locked, the alarm is triggered if the electrical connection with the trailer is cut off.

Before hitching or unhitching a trailer, always turn off the anti-theft alarm. Otherwise, the tilt sensor could cause the alarm to go off.

Trailers with LED rear lights

For technical reasons, trailers fitted with LED rear lights cannot be connected to the anti-theft alarm system.

When the vehicle is locked, the alarm does not go off when the electrical connection with the trailer is cut if it has rear lights with light-emitting diodes.

If the system cannot detect the attached trailer or if the towing bracket has been refitted by an auto repair shop other than CUPRA, you must manually select the **Normal** profile before you start driving with a trailer attached.

WARNING

If the cables are improperly or incorrectly connected, it may lead to an excessive amount of current supplied to the trailer, which can cause abnormalities in the entire vehicle electronic system, as well as accidents and serious injuries.

- Ensure that any repairs that need to be carried out on the electrical system are carried out by a specialised workshop.
- Never connect the trailer's electric system directly to the electrical connections

of the tail lights or any other power sources.

WARNING

Contact between the pins of the trailer power socket can cause short circuits, overloading of the electrical system or failure of the lighting system, and consequently can cause accidents and serious injuries.

- Never connect the pins of the trailer power socket to each other.
- Make sure any work on bent pins is carried out by a specialised workshop.

CAUTION

Do not leave the trailer connected to the vehicle when parked; place it on its support wheel or its supports. If the vehicle rises or falls due, for example, to a variation of the load or a burst tyre, increased pressure will be placed on the towing bracket and the trailer, and both the vehicle and the trailer can be damaged.

Note

- In case of malfunctioning of the electrical systems of the vehicle or trailer, as well as of the anti-theft system, have these checked out by a specialised workshop.
- If the trailer accessories consume energy through the power socket to the trailer and

the engine is turned off, the battery will discharge.

- If the vehicle battery is running low, the electrical connection with the trailer will be automatically cut.

Loading a trailer

Technically permissible maximum trailer weight and vertical load on the coupling device

The technically permissible maximum trailer weight is the weight that the vehicle can tow >>> . The vertical load on the coupling load is exerted vertically from above on the tow hitch of the towing bracket >>> page 345.

The information on the maximum trailer weight and vertical load on the coupling device contained in the type plate of the towing bracket are experimental values only. The correct figures for your specific model, which may be *lower* than these figures, are given in the vehicle documentation. The information in the vehicle documentation takes precedence at all times.

To promote safety while driving, CUPRA recommends making the most of the maximum **vertical load** technically permissible on the coupling device >>> page 296. An insufficient vertical load has a negative influence on the behaviour of both the vehicle and trailer.

The vertical load increases the weight on the rear axle, reducing the vehicle's carrying capacity.

Gross combination weight of the towing vehicle and trailer

The gross combination weight is the actual weight of the loaded vehicle plus the actual weight of the loaded trailer.

In some countries trailers are classified into distinct categories. CUPRA recommends obtaining information from a specialised workshop regarding which type of trailer is most suitable for your vehicle.

Trailer loading

The weight of the towing vehicle and trailer must be balanced. In order to do this, the load must be as close as possible to the maximum vertical load technically permissible on the coupling point, and it must be evenly distributed between the back and front of the trailer:

- Distribute loads in the trailer so that heavy objects are as near to the axle as possible or above it.
- Secure the trailer load properly.

Tyre pressure

Set the tyre pressure of the trailer tyres in accordance with the trailer manufacturer's recommendations.

When towing a trailer, inflate the tyres of the towing vehicle with the maximum allowable pressure >>> page 322.

WARNING

If the maximum permissible axle weight, the maximum load technically permissible on the coupling point, the maximum authorised vehicle weight or the gross combination weight of the towing vehicle and trailer are exceeded, accidents and serious injuries may occur.

- Never exceed the values indicated!
- The actual weight on the front and rear axles must never exceed the maximum permissible axle weight. The weight on the front and rear axles must never exceed the maximum permissible weight.

WARNING

A shift in weight could jeopardize the stability and security of the towing vehicle and trailer, which could lead to accidents and serious injuries.

- Always load the trailer correctly.
- Always secure the load properly using belts or straps that are suitable and in good condition.

Driving with a trailer

Adjusting the headlights

The front part of the vehicle may be raised when the trailer is connected and the light may dazzle the rest of the traffic.

Adapt the height of the headlights using the headlight range adjuster >>> page 138¹⁾.

Special characteristics of driving with a trailer



- If your trailer has an **overrun brake**, brake *gently at first* and then rapidly. This will prevent the jerking that can be caused by the locking of trailer wheels.
- Due to the gross combination weight of the towing vehicle and trailer, the braking distance increases.
- When going down a slope, go into a lower gear (in tiptronic automatic gearbox mode) to take advantage of the braking power provided by the engine. Otherwise, the braking system could overheat and even fail.
- The trailer weight, as well as the gross combination weight of the towing vehicle and trailer, change the centre of gravity and the properties of the vehicle.

- If the towing vehicle is empty and the trailer is loaded, then the load distribution is incorrect. Under these conditions, drive slowly and with extra caution.

Hill starts with a trailer

Depending on the slope of the hill and the combination weight of the towing vehicle and trailer, the vehicle might start rolling backwards slightly when you first start up.

For hill-starting with a trailer, do the following:

- Press and hold the brake pedal.
- Press the  button to disconnect the electronic parking brake >>> page 217.
- Move the selector lever to the **D/S** >>> page 224 position.
- Pull out the  button and hold it in that position to stop the towing vehicle and trailer with the electronic parking brake.
- Release the brake pedal.
- Start driving slowly.
- Do not release the  button until the engine has sufficient force to start driving.

WARNING

If a trailer is pulled incorrectly, this may lead to loss of control of the vehicle and serious injury.

- Driving with a trailer and transporting heavy or large objects will change the vehicle handling and braking distances.
- Always drive cautiously and carefully. Brake earlier than usual.
- Adapt your speed and driving style at all times to suit visibility, weather, road and traffic conditions. Slow down, especially when driving down hills or slopes.
- Accelerate with particular care and caution. Avoid sudden braking and manoeuvres.
- Take great care when overtaking. Reduce speed immediately if you notice that the trailer is swaying, however slightly.
- Never attempt to “straighten” the towing vehicle and trailer while accelerating.
- Take into account the speed limit for vehicles with a trailer, as it could be lower than for vehicles without a trailer.



¹⁾ This does not apply for vehicles with Full LED xenon headlights.

Stabilisation of the towing vehicle and trailer

The stabilisation of the towing vehicle and trailer together is an additional function of the electronic stability control (ESC).

If the system detects that the trailer is swaying, it intervenes automatically with the driver steering recommendation to reduce the swaying of the trailer.

Requirements for the stabilisation of the towing vehicle and trailer

- The vehicle is factory-equipped with a towing bracket or has been retro-fitted with a compatible towing bracket.
- The ESC and ASR are active. The control lamp  or  is not lit up on the instrument panel.
- The trailer is electrically connected to the towing vehicle through the trailer power socket.
- The vehicle is travelling at over 60 km/h (approx. 37 mph).
- The maximum vertical load technically permissible is being utilised on the coupling device.
- The trailer has a rigid draw bar.
- If the trailer has brakes, it must be equipped with a mechanical overrun brake.

⚠ WARNING

The enhanced security provided by the electric stability control of the towing vehicle and trailer should not lead you to take any risks that could compromise your safety.

- Adapt your speed and driving style at all times to suit visibility, weather, road and traffic conditions.
- Accelerate with caution when the road is slippery.
- When adjusting any settings, stop accelerating.

⚠ WARNING

The electric stability control for the towing vehicle and trailer may not correctly detect all driving conditions.

- When the ESC is switched off, the stabilisation of the towing vehicle and trailer is also switched off.
- The stability system does not always detect light and unstable trailers, so it may not stabilise these correctly.
- When driving on slippery surfaces with poor grip, the trailer can even *interfere* with the stability system.
- Trailers with a high centre of gravity can tip even without having previously swayed.
- If a trailer is not attached, but the trailer power socket is connected (e.g. installation of a bicycle rack with lights), repeated au-

tomatic braking may occur in extreme driving conditions.

Retrofitting a towing bracket

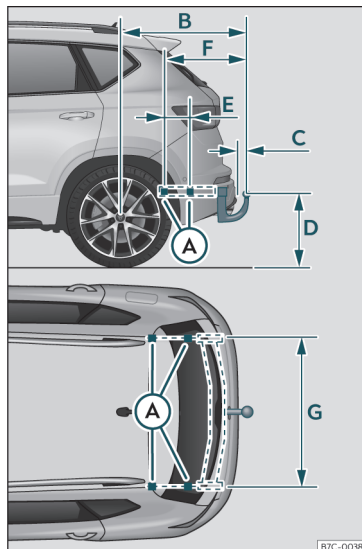

Fig. 245 Limits and attachment points for retrofitting a towing bracket. »

CUPRA recommends that towing brackets be retrofitted at a specialised workshop. For example, it may very well be necessary to adjust the cooling system or mount thermal protection plates. To do so, CUPRA recommends going to a specialised CUPRA dealer or any SEAT dealership.

If a towing bracket is retrofitted, the distance specifications should always be kept in mind. The distance between the centre of the spherical head and the road »» Fig. 245 ⓐ must never be less than that indicated. This also applies when the vehicle is fully loaded, including the technically permissible maximum vertical load on the coupling device.

Distance specifications »» Fig. 245:

- Ⓐ Attachment points
- Ⓑ 950.5 mm
- Ⓒ 65 mm min.
- Ⓓ 350–420 mm
- Ⓔ 220 mm
- Ⓕ 633.5 mm
- Ⓖ 1,043 mm

⚠ WARNING

If the cables are improperly or incorrectly connected, this may lead to malfunctions in the entire vehicle electronic system, as well as to accidents and serious injuries.

- Never connect the trailer's electric system to the electrical connections of the tail lights or any other unsuitable power sources. Only use suitable connectors to connect the trailer.
- The towing bracket should be retrofitted only at a specialised workshop.

⚠ WARNING

If the towing bracket is badly fitted or unsuitable, the trailer may separate from the vehicle while driving. This could cause serious accidents and fatal injuries.

ℹ Note

Only use towing brackets that have been approved by CUPRA for the model in question.

Practical tips

Care and maintenance

Accessories and modifications to the vehicle

Accessories, replacement parts and repair work

Always ask your dealer or specialist retailer for advice before purchasing accessories and replacement parts.

Your vehicle is designed to offer a high standard of active and passive safety. For this reason, we recommend that you ask a specialised CUPRA Service or SEAT Official Service for advice before fitting accessories or replacement parts. Your Official Service has the latest information from the manufacturer and can recommend accessories and replacement parts which are suitable for your requirements. They can also answer any questions you might have regarding official regulations.

We recommend you to use only **CUPRA accessories** and **Genuine CUPRA parts**®. Specialised CURA Services or SEAT Official Services have the necessary experience and fa-

cilities to ensure that the parts are installed correctly and professionally.

Any **retro-fitted equipment** which has a direct effect on the vehicle and/or the way it is driven, such as a cruise control system or **electronically-controlled suspension**, must be approved for use in your vehicle and bear the **e** mark (the European Union's authorisation symbol).

If any **additional electrical devices** are fitted which do not serve to control the vehicle itself (for instance a refrigerator box, laptop or ventilator fan, etc.), they must bear the **CE** sign (manufacturer conformity declaration in the European Union).

WARNING

Accessories, for example telephone holders or cup holders, should never be fitted on the covers, or within the working range of the airbags. Otherwise, there is a danger of injury if the airbag is triggered in an accident.

Technical modifications

Modifications must always be carried out according to our specifications.

Unauthorised modifications to the electronic components, software, wiring or data transfer in the vehicle may cause malfunc-

tioning. Due to the way the electronic components are linked together in networks, other indirect systems may be affected by the faults. This can seriously impair safety, lead to excessive wear of components, and also invalidate your vehicle registration documents.

You will appreciate that your specialised CUPRA dealer or SEAT dealership cannot be held liable for any damage caused by modifications and/or work performed incorrectly in the vehicle.

We therefore recommend that all work should be performed by a specialised CUPRA Service or a SEAT Official Service using **genuine CUPRA parts**®.

WARNING

Incorrectly performed modifications or other work on your vehicle can lead to malfunctions and cause accidents.

Radio transmitters and office equipment

Radio transmitters (fixed installation)

Any retrofit installations of radio transmitters in the vehicle require prior approval. CUPRA generally authorises in-vehicle installations of approved types of radio transmitters provided that: »

- The aerial is installed correctly.
- The aerial is installed on the exterior of the vehicle (and shielded cables are used together with non-reflective aerial trimming).
- The effective transmitting power does not exceed 10 Watts at the aerial base.

A specialised CUPRA Service, SEAT Official Service or specialised workshop will be able to inform you about options for installing and operating radio transmitters with a *higher* transmitting power.

Mobile radio transmitters

Commercial mobile telephones or radio equipment might interfere with the electronics of your vehicle and cause malfunctions. This may be due to:

- No external aerial.
- External aerial incorrectly installed.
- Transmitting power more than 10 W.

You must, therefore, do not operate portable mobile telephones or radio equipment *inside the vehicle* without a properly installed external aerial >>> .

Please note also that the maximum range of the equipment can only be achieved with an *external* aerial.

Business equipment

Retrofit installation of business or private equipment in the vehicle is permitted, provided the equipment cannot interfere with the driver's immediate control of the vehicle and that any such equipment carries the CE mark. Any retrofit equipment that could influence the driver's control of the vehicle must have a type approval for your vehicle and must carry the e mark.

WARNING

Mobile telephones or radio equipment which is operated inside the vehicle without a properly installed external aerial can create excessive magnetic fields that could cause a health hazard.

Note

- The posterior fitting of electric and electronic equipment in this vehicle affects its licence and could lead to the withdrawal of the vehicle registration document under certain circumstances.
- Please use the mobile telephone / radio operating instructions.

Checking and refilling levels

Filling the tank

Refuelling

Read the additional information carefully >>>  page 41

If the automatic filler nozzle is operated correctly, it will switch itself off as soon as the fuel tank is "full". Do not try to put in more fuel after the nozzle cuts out, as this will fill the expansion chamber in the fuel tank.

The correct fuel grade for your vehicle is given on a sticker on the inside of the fuel tank flap. Further notes on fuel can be found at >>> page 309.

The capacity of your vehicle's fuel tank is given in >>>  page 41.

WARNING

- Fuel is highly flammable and can cause serious burns and other injuries.
- When refuelling, turn off the engine and turn off the ignition for safety reasons.
 - Do not smoke when filling the fuel tank or a canister. Naked flames are forbidden in the vicinity due to the risk of explosion.
 - Observe legislation governing the use, storage and carrying of a spare fuel canister in the vehicle.

- For safety reasons we do not recommend carrying a spare fuel canister in the vehicle. In an accident the canister could be damaged and could leak.
- If, in exceptional circumstances, you have to carry a spare fuel canister, please observe the following points:
 - Never fill fuel into the spare fuel canister if it is inside or on top of the vehicle. An electrostatic charge could build up during filling, causing the fuel vapour to ignite. Danger of explosion. Always place the canister on the ground to fill it.
 - Insert the filling nozzle as far as possible into the spare fuel canister.
 - If the spare fuel canister is made of metal, the filling nozzle must be in contact with the canister during filling. This helps prevent an electrostatic charge building up.
 - Never spill fuel in the vehicle or in the luggage compartment. Fuel vapour is explosive. Risk of fatal accident!

⚠ CAUTION

- If any fuel is spilt onto the vehicle, it should be removed immediately. It could otherwise damage the paintwork.

- Never run the tank completely dry. An irregular fuel supply could cause misfiring. As a result, unburnt fuel could enter the exhaust system and damage the catalytic converter.
- When filling the fuel tank after having run it completely dry on a vehicle with a diesel engine, the ignition must be switched on for at least 30 seconds before starting the engine. When you then start the engine it may take longer than normal (up to one minute) to start firing. This is because air needs to be bled from the fuel system while starting.

♻ For the sake of the environment

Do not overfill the fuel tank, it may cause the fuel to overflow if it becomes warm.

📘 Note

There is no emergency mechanism for the manual release of the fuel tank flap. If necessary, request assistance from specialised personnel.

📘 Note

Diesel vehicles are fitted with a protective device that prevents the insertion of the wrong fuel hose¹⁾. It is only possible to refuel with Diesel nozzles.

- If the pump nozzle is worn, damaged, or if it is very small, it is possible that it will not be able to open the protective device. Before trying to insert the pump nozzle by turning it, try a different pump or request specialist help.
- If you fill the tank from a reserve fuel canister, the protective device will not open. One way to resolve this is to pour the fuel in very slowly.

Fuel

Identification of the fuel¹⁾

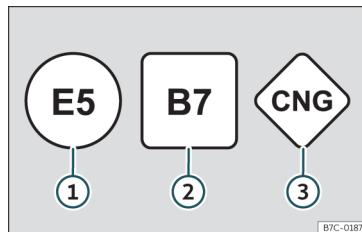

Fig 246 Sticker on the tank cap (identification of the fuel)

¹⁾ Depending on country

Fuels are identified with different symbols. Depending on the fuel, the different symbols are on the pump and the tank lid of your vehicle. The identification serves to prevent confusion when choosing the fuel.

- ① **Petrol** with ethanol (“E” stands for **E**thanol). The number indicates the percentage of ethanol in the petrol. “E5” means, for example, an ethanol ratio of 5% max.
- ② **Diesel** with biodiesel (“B” stands for **B**iodiesel). The number indicates the percentage of biodiesel in the diesel. “B7” means, for example, a proportion of biodiesel of max. 7%.
- ③ **Natural gas**: “CNG” means **C**ompressed **N**atural **G**as.

Type of petrol

The correct grade of petrol is listed inside the fuel tank flap.

The vehicle is equipped with a catalytic converter and must only be run on **unleaded petrol**. The petrol must comply with the standard EN 228 and be **sulphur-free**. Fuels with a 10% ethanol ratio can be refuelled (E10)¹⁾. The types of petrol are differentiated

by using the **octane numbers (RON)** or via the **anti-knock index (AKI)**.

The following pieces of text show the information included in the corresponding stickers on the tank lid (examples):

Unleaded super plus 98 octane petrol or super 95 octane petrol at least

We recommend refuelling with super plus 98 octane petrol (93 AKI). If not available: super 95 octane petrol (91 AKI) (with a slight power loss).

If super is not available, *if necessary*, use normal 91 octane petrol (87 AKI). In this case only use moderate engine speeds and a light throttle. Refuel with super as soon as possible.

⚠ CAUTION

- Fuels high percentage of ethanol, e.g. E30 - E100 button must not be used. The fuel system would be damaged.
- A single refuelling with leaded fuel or other metal additives entails a permanent deterioration of the effectiveness of the catalytic converter.
- Only use fuel additives that have been approved by SEAT. The products that contain substances to increase the octane rat-

ing or decrease knocking may contain metal additives that damage the engine and catalytic converter. This type of products must not be used.

- Do not use fuels shown in the pump as containing metals. LRP (*lead replacement petrol*) fuels contain high concentrations of metal additives. Risk of engine damage!
- High engine speed and full throttle can damage the engine when using petrol with an octane rating lower than the correct grade for the engine.

📘 Note

- Fuel with an octane rating higher than the one required by the engine can be used.
- In countries in which there is no sulphur-free fuel, it is also allowed to use low sulphur content fuel.

Engine compartment

Working in the engine compartment

Read the additional information carefully
 >>> 📖 page 17

¹⁾ Follow the regulations of the country you are driving in.

Always be aware of the danger of injury and scalding as well as the risk of accident or fire when working in the engine compartment (e.g. when checking and refilling fluids). Always observe the warnings listed below and follow all general safety precautions. The engine compartment of the vehicle is a potentially hazardous area >>> ⚠.

⚠ WARNING

- Switch off the engine and activate the hand brake. Place the selector lever in P. Let the engine cool.
- Keep children away from the engine compartment.
- Never spill liquids used for vehicle operation on the engine compartment, as these may catch fire (e.g. the antifreeze in coolant).
- Take care not to cause short circuits in the electrical system, especially when working on the battery.
- If working inside the engine compartment, remember that, even when the ignition is switched off, the radiator fan may start up automatically, and therefore there is a risk of injury.
- Never cover the engine with additional insulating materials such as a blanket. Risk of fire!
- Do not unscrew the cap on the coolant expansion tank when the engine is hot. The cooling system is under pressure.

- Protect face, hands and arms by covering the cap with a large, thick rag to protect against escaping coolant and steam.
- If it is necessary to work in the engine compartment while the engine is running, the rotating components (for example, poly-V belt, alternator, radiator fan) and the high voltage ignition system are an additional hazard.
- Observe the following additional warnings if work on the fuel system or the electrical system is necessary:
 - Always disconnect the battery from the on-board network.
 - Do not smoke.
 - Never work near naked flames.
 - Always keep an approved fire extinguisher immediately available.

⚠ CAUTION

When topping up fluids make sure the correct fluid is put into the correct filler opening, otherwise this can cause serious malfunctions or engine damage.

♻ For the sake of the environment

Inspect the ground underneath your vehicle regularly so that any leaks are detected at an early stage. If you find spots of oil or other fluids in the area where it was parked, have your vehicle inspected at the workshop.

📘 Note

In right-hand drive vehicles* some brake fluid reservoirs are on the other side of the engine compartment >>> Fig. 247.

Opening and closing the bonnet

Read the additional information carefully >>> 📖 page 17

⚠ WARNING

- Never open the bonnet if you see steam or drips of coolant being released from the engine compartment. Failure to comply could result in burns. Wait until no steam or coolant can be seen before opening the bonnet.
- For safety reasons the bonnet must always be completely closed when the vehicle is moving. Therefore, after closing the bonnet, always check that the locking element is properly engaged. This is the case if the bonnet is flush with the adjacent body panels.
- Should you notice that the bonnet is not safely secured when the vehicle is moving, stop the vehicle immediately and close the bonnet. Failure to follow this instruction could result in an accident. »

CAUTION

To avoid damage to the bonnet and to the windscreen wiper arms, only open it when the windscreen wipers are in place against the windscreen.

Checking levels

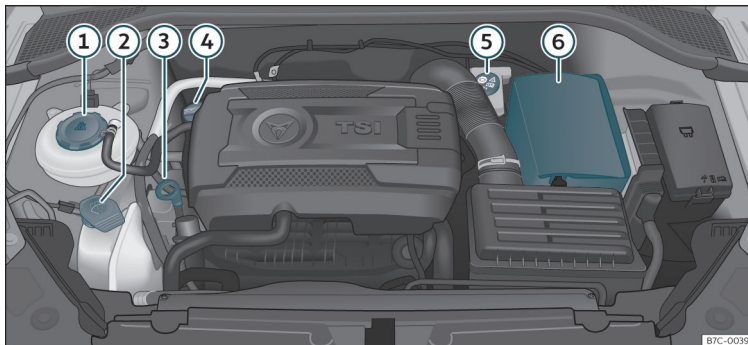

Fig. 247 Diagram for the location of the various elements.

From time to time, the levels of the different fluids in the vehicle must be checked. Never fill with incorrect fluids, otherwise serious damage to the engine may be caused.

- ① Coolant expansion tank
- ② Windscreen washer reservoir
- ③ Engine oil dipstick
- ④ Engine oil filler cap
- ⑤ Brake fluid reservoir
- ⑥ Vehicle battery (underneath the cover)

The checking and refilling of service fluids are carried out on the components men-

tioned above. These operations are described in »» page 310.

Overview

You will find further explanations, instructions and restrictions on the technical specifications as of »» page 344.

Engine oil

General notes

The engine comes with a special, multi-grade oil that can be used all year round.

Because the use of high-quality oil is essential for the correct operation of the engine and its long useful life, when topping up or changing oil, use only those oils that comply with VW standards.

The specifications (VW standards) set out in the following page should appear on the container of the service oil; when the container displays the specific standards for petrol and diesel engines together, it means that the oil can be used for both types of engines.

We recommend that the oil change indicated in the Maintenance Programme, be performed by a technical service or specialised workshop. »

The correct oil specifications for your engine are listed in the >>>  page 42.

Service intervals

Service intervals can be flexible (LongLife service) or fixed (dependent on time/distance travelled).

Flexible service intervals (LongLife service intervals*)

Special oils and processes have been developed which, depending on the characteristics and individual driving profiles, enable the extension of the oil change service (LongLife service intervals).

Because this oil is essential for extending the service intervals, it **must only** be used observing the following indications:

- Avoid mixing it with oil for fixed service intervals.
- Only in exceptional circumstances, if the engine oil level is too low >>> page 314, **Checking engine oil level** and LongLife oil is not available, it is permitted to top up (once) with oil for **fixed service intervals** >>>  page 42 (up to a maximum of 0.5 litres).

Fixed service intervals*

If your vehicle does not have the “LongLife service interval” or it has been disabled (by

request), you may use oils for **fixed service intervals**, which also appear in >>>  page 42. In this case, your vehicle must be serviced after a fixed interval of 1 year/15,000 km (10,000 miles)(whatever comes first) >>> page 331.

Warning lamp



It lights up red



Do not continue driving!
Engine oil pressure too low.



It lights up yellow

Check the engine oil level as soon as possible.
Top up the oil at the next opportunity >>> page 315.



It flashes yellow

Fault in the oil level sensor.
Take the vehicle to a specialised workshop to have the system inspected. Until then it is advisable to check the oil level every time you refuel.

If this warning symbol  starts to flash, and is accompanied by three **audible warnings**, switch off the engine and check the oil level. If necessary, add more oil >>> page 315.

If the warning lamp  flashes although the oil level is correct, **stop driving**. Do not even run the engine at idle speed! Obtain technical assistance.

Checking engine oil level

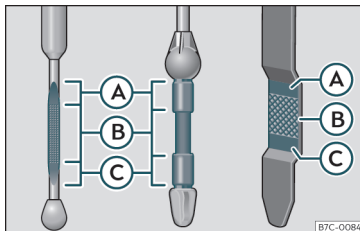

Fig. 248 Engine oil dipstick.

Read the additional information carefully >>> page 41

The engine oil dipstick indicates the level of the oil.

Checking oil level

- Park the vehicle in a horizontal position.
- Briefly run the engine at idle speed until the operating temperature is reached and then stop.
- Wait for about two minutes.
- Pull out the dipstick. Wipe the dipstick with a clean cloth and insert it again, pushing it in as far as it will go.
- Then pull it out once more and check the oil level >>> Fig. 248. Top up with engine oil if necessary.

Depending on how you drive and the conditions in which the vehicle is used, oil consumption can be up to 0.5 l/1000 km. Oil consumption is likely to be higher for the first 5,000 km. For this reason the engine oil level must be checked at regular intervals, preferably when filling the tank and before a journey.

⚠ WARNING

Any work carried out in the engine compartment or on the engine must be carried out cautiously.

- When working in the engine compartment, always observe the safety warnings >>> page 310.

ⓘ CAUTION

If the oil level is above area **A**, do not start the engine. This could result in damage to the engine and catalytic converter. Contact a Technical Service.

Topping up engine oil

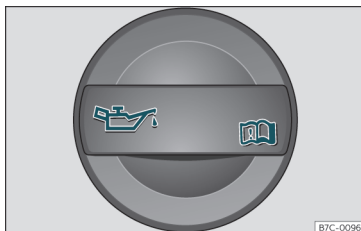

Fig. 249 In the engine compartment: Engine oil filler cap.

Read the additional information carefully >>> page 41

Before opening the bonnet, read and observe the warnings >>> in Working in the engine compartment on page 311.

The position of the oil filler opening is shown in the corresponding engine compartment illustration >>> page 313.

Engine oil specification >>> page 42.

⚠ WARNING

Oil is highly inflammable! Ensure that no oil comes into contact with hot engine components when topping up.

ⓘ CAUTION

If the oil level is above area >>> Fig. 248 **A**, do not start the engine. This could result in damage to the engine and catalytic converter. Contact a specialised workshop.

🌿 For the sake of the environment

The oil level must never be above zone >>> Fig. 248 **A**. Otherwise oil can be drawn in through the crankcase breather and leak into the atmosphere via the exhaust system.

ⓘ Note

Before a long trip, we recommend finding an engine oil that conforms to the corresponding VW specifications and recommend keeping it in the vehicle. This way, the correct engine oil will always be available for a top-up if needed.

Changing engine oil

Read the additional information carefully >>> page 41.

The engine oil must be changed at the intervals given in the service schedule.

We recommend that you have the engine oil changed by a Technical Service. »

The oil change intervals are shown in the Maintenance Programme.

WARNING

Only change the engine oil yourself if you have the specialist knowledge required!

- Before opening the bonnet, read and observe the warnings >>> page 310.
- Wait for the engine to cool down. Hot oil may cause burn injuries.
- Wear eye protection to avoid injuries, such as acid burns, caused by splashes of oil.
- When removing the oil drain plug with your fingers, keep your arm horizontal to help prevent oil from running down your arm.
- Wash your skin thoroughly if it comes into contact with engine oil.
- Engine oil is poisonous! Used oil must be stored in a safe place out of the reach of children.

CAUTION

No additives should be used with engine oil. This could result in engine damage. Any damage caused by the use of such additives would not be covered by the factory warranty.

For the sake of the environment

- Because of disposal problems and the special tools and specialist knowledge required, we recommend that you have the engine oil and filter changed by a Technical Service.
- Never pour oil down drains or into the ground.
- Use a suitable container when draining the used oil. It must be large enough to hold all the engine oil.

Cooling system

Topping up coolant



Read the additional information carefully >>>  page 42

Top up coolant when the level is below the MIN (minimum) mark.

Checking coolant level

- Park the vehicle in a horizontal position.
- Switch the ignition off.
- Read off the coolant level on coolant expansion tank. When the engine is cold, the coolant level should be between the marks. When the engine is hot, it may be slightly above the upper mark.

Topping up coolant

- Wait for the engine to cool down.
- Cover the coolant expansion tank cap with a cloth and carefully unscrew it to the left >>> .
- Top up the coolant only if there is still coolant in the expansion tank, otherwise you could **damage the engine**. If there is no coolant in the expansion tank, do not continue driving. You should obtain professional assistance >>> .
- If there is still some coolant in the expansion tank, top up to the upper mark.
- Top up with coolant until the level becomes stable.
- Screw the cap back on correctly.

Any loss of coolant fluid normally indicates a leak in the cooling system. Take the vehicle straight to a specialised workshop to have the cooling system examined. If there are no leaks in the engine cooling system, a loss of coolant can only occur if the coolant boils and is forced out of the system as a result of overheating.

WARNING

- The cooling system is under pressure. Do not unscrew the cap on the coolant expansion tank when the engine is hot: risk of burns!

- The antifreeze and coolant fluid can be a health hazard. Therefore, the antifreeze should be stored in the original container in a safe place out of reach of children. Failure to comply could result in poisoning.
- If working inside the engine compartment, remember that, even when the ignition is switched off, the radiator fan may start up automatically, and therefore there is a risk of injury.

WARNING

If there is not enough anti-freeze in the coolant system, the engine may fail leading to serious damage.

- Please make sure that the percentage of additive is correct with respect to the lowest expected ambient temperature in the zone in which the vehicle is to be used.
- When the outside temperature is very low, the coolant could freeze and the vehicle would be immobilised. In this case, the heating would not work either and inadequately dressed passengers could die of cold.

CAUTION

Do not top up the expansion tank with coolant fluid if it is empty! Air could enter the cooling system. In this case, stop driving. Seek specialist assistance. Otherwise, there is a risk of engine damage.

CAUTION

The original additives should never be mixed with coolants which are not approved by SEAT. Otherwise, you run the risk of causing severe damage to the engine and the engine cooling system.

- If the fluid in the expansion tank is not purple but is, for example, brown, this indicates that the G13 additive has been mixed with an inadequate coolant. The coolant must be changed as soon as possible if this is the case! This could result in serious faults and engine damage.

For the sake of the environment

Coolants and additives can contaminate the environment. If any fluids are spilled, they should be collected and correctly disposed of, with respect to the environment.

Brake fluid

Top up brake fluid

Read the additional information carefully
>>>  page 43

Checking the brake fluid level

The brake fluid level must be between the MIN and MAX markings.

However, if the brake fluid level goes down noticeably in a short time, or drops below the MIN mark, there may be a leak in the brake system. Seek specialist assistance. A warning light on the instrument panel display monitors the brake fluid level
>>>  page 36.

In right-hand drive vehicles the brake fluid reservoir is on the other side of the engine compartment.

Changing brake fluid

The regular intervals at which the brake fluid should be replaced are listed in the Maintenance Programme. We recommend you have it replaced at a specialised CUPRA Service or SEAT Official Service, during an inspection service.

WARNING

- Brake fluid should be stored in the closed original container in a safe place out of reach of children. Risk of poisoning!
- If the brake fluid is left in the system for too long and the brakes are subjected to heavy use, vapour bubbles may form in the brake system. This would seriously affect the efficiency of the brakes and the safety of the vehicle. This may cause an accident. »

ⓘ CAUTION

Brake fluid should not come into contact with the vehicle paintwork, as it is abrasive.



Windscreen washer reservoir

Checking and topping up the windscreen washer reservoir

Read the additional information carefully
 >>>  page 43

Check the water level in the windscreen washer reservoir regularly and top up as required.

The container for the windscreen washer contains the cleaning fluid for the windscreen, the rear window and the headlight washer system*.

- Open the bonnet  >>> page 310.
- The windscreen washer reservoir is marked with the symbol  on the cap.
- Check there is enough windscreen water in the reservoir.

Recommended windscreen wipers

- For the hottest seasons we recommend summer G 052 184 A1 for clear glass. Proportions of the mixture in the washer fluid tank:

1:100 (1 part concentrate per 100 parts water).

- All year round, G 052 164 A2 for clear glass. Approximate proportion of the winter mixture, up to -18°C (0°F): 1:2 (1 part concentrate per 2 parts water); otherwise, a 1:4 proportion of mixture in the washer fluid tank.

Capacity

The reservoir holds approximately 3 litres in versions without headlight washer and 5 litres in versions with headlight washer.

 WARNING

If the water from the windscreen washer does not contain enough anti-freeze, it may freeze on the windscreen and rear window, reducing forward and rear visibility.

- In winter, ensure the windscreen washer contains enough anti-freeze.
- In cold conditions, you should not use the windscreen wiper system unless you have warmed the windscreen with the ventilation system. The antifreeze could freeze on the windscreen and reduce visibility.

 WARNING

Never mix an unsuitable antifreeze or other similar additives with the windscreen washer water. A greasy layer may be formed on the windscreen which will impair visibility.

- Use clean water with a window cleaner recommended by CUPRA.
- If necessary, add a suitable antifreeze to the water in the reservoir.

ⓘ CAUTION

- Do not mix cleaning products recommended by CUPRA with other products. This could lead to flocculation and may block the windscreen washer jets.
- When topping up service fluids, make absolutely certain that you fill the fluids into the correct reservoirs. Using the wrong fluids could cause serious malfunctions and engine damage!
- Not having windscreen wiper fluid reduces visibility through the windscreen, and leads to loss of visibility in headlights in models with headlight washer.

Battery

General information

Read the additional information carefully
 >>>  page 44.

The battery is located in the engine compartment and is almost **maintenance-free**. It is checked as part of the Inspection Service. Nevertheless, check the terminals are

clean and have the correct tightening torque, especially in summer and winter.

Disconnecting the battery

The battery should only be disconnected in exceptional cases. When the battery is disconnected, some of the vehicle's functions are "lost" (>>> table on page 319). These functions will require resetting after the battery is reconnected.

Deactivate the anti-theft alarm* before you disconnect the battery. Otherwise the alarm will be triggered.

Function	Reprogramming
One-touch function of the electric windows	>>> page 128, One-touch opening and closing.
Remote control key	If the vehicle does not respond to the key, they should be synchronised >>> page 121.
Digital clock	>>> page 104.
ESC warning lamp	After driving for a few metres, the warning lamp goes out again.

If the vehicle is not used for long periods

The vehicle has a system for monitoring the current consumption when the engine is left unused for long periods of time >>> page 234. Some functions, such as the interior lights,

or the remote door opening, may be temporarily disabled to prevent the battery from running flat. These functions will come back on as soon as the ignition is switched on and the engine started.

Winter conditions

During the winter, the starting power may be reduced, and if necessary, the battery should be charged >>>  in Important safety warnings for handling a vehicle battery on page 319

Warning lamp

It lights up

Alternator fault.

The control lamp lights up when the ignition is switched on. It should go out when the engine has started running.





If the control lamp  lights up while driving, the alternator is no longer charging the battery. You should immediately drive to the nearest specialised workshop.

You should avoid using electrical equipment that is not absolutely necessary because this will drain the battery.

Important safety warnings for handling a vehicle battery

All work on batteries requires specialist knowledge. Please refer to a specialised CUPRA Service, SEAT Official Service or a workshop specialising in batteries: risk of burns or exploding battery!

The battery must not be opened. Never try to change the fluid level of the battery. Otherwise explosive gas is released from the battery that could cause an explosion.

	Wear eye protection.
	Battery acid is very corrosive and caustic. Wear protective gloves and eye protection. In the event of electrolyte splashes, rinse off with plenty of water.
	Fires, sparks, open flames and smoking are prohibited.
	The battery should only be charged in a well-ventilated zone. Risk of explosion!
	Keep children away from acid and batteries!

WARNING

- When repairing or working on the electrical system, proceed as follows:
 1. Remove the key from the ignition. The negative cable on the battery must be disconnected. »

- 2. When the repair is finished, reconnect the negative pole of the battery.
- Switch off all electrical devices before re-connecting the battery. Reconnect first the positive cable and then the negative cable. Never reverse the polarity of the connections. This could cause an electrical fire.
- Ensure that the vent hose is always connected to the battery.
- Never use damaged batteries. This could cause an explosion! Replace a damaged battery immediately.

ⓘ CAUTION

- Never disconnect the battery if the ignition is switched on or if the engine is running. This could damage the electrical system or electronic components.

Charging the battery

Terminals for charging the battery are fitted in the engine compartment.

- Note the warnings >>> ⚠ in Important safety warnings for handling a vehicle battery on page 319 and >>> ⚠.
- Switch off all electrical devices. Remove the ignition key.
- Raise the bonnet >>> 📖 page 17.
- Open the battery cover.

- Connect the charger clamps as described to the **positive pole of the battery (+)** and exclusively to an **earth on the bodywork (-)**.
- Only use a charger which is compatible for use with 12 V nominal voltage batteries. The charge must not exceed a voltage of 15 V.
- Now connect the battery charger to the power socket and switch on.
- At the end of the charging process: switch off the battery charger and disconnect the power socket cable.
- Finally disconnect the charger cables from the battery.
- Replace the battery cover correctly.
- Close the bonnet >>> 📖 page 17.

Important: Before you charge the battery make sure you read the manufacturer's instructions for using the battery charger.

⚠ WARNING

Never charge a battery that has frozen: replace it! Failure to do so may lead to an explosion.

📘 Note

Use only the terminals in the engine compartment to charge the battery.

Replacing the battery

The new battery should have the same specifications (amperage, load and voltage) as the used battery.

Your vehicle is equipped with an intelligent power management system to control the distribution of electrical energy >>> page 234. The power management function ensures that the battery is charged much more efficiently than on vehicles without a power management system. To maintain this function after replacing the battery, we recommend that the replacement battery used is of the same make and type as the original fitted battery. To make proper use of the power management function after the battery has been changed, have the battery coded to the power management mode at a specialised workshop.

ⓘ CAUTION

- Some vehicles, for example those with the Start-Stop system* are fitted with a special battery (AGM-type or EFB-type battery). If any other type of battery is fitted, the Start-Stop function may be considerably reduced and the vehicle may not stop on repeated occasions.
- Make sure that the vent hose is always attached to the original opening on the side of the battery. Gases or battery acid can

otherwise escape and possibly cause damage.

- The battery holder and clamps must always be correctly secured.
- Before starting any work on the battery, always observe the warnings listed under >>> page 319, Important safety warnings for handling a vehicle battery.
- Do not forget to replace the battery coverings, where applicable. It is a protection for high temperatures. This in turn extends the vehicle service life.

For the sake of the environment

 Batteries contain toxic substances including sulphuric acid and lead. They must be disposed of appropriately and must not be disposed of with ordinary household waste. Make sure disconnected batteries cannot tip over. Sulphuric acid could be spilt!

Wheels

Wheels and tyres

General notes

- When driving with **new tyres**, be especially careful during the first 500 km (300 miles).
- If you have to drive over a kerb or similar obstacle, drive very slowly and as near as possible at a right angle to the obstacle.
- Check from time to time if the tyres are damaged (punctures, cuts, cracks or dents). Remove any foreign objects embedded in the treads.
- Damaged wheels and tyres must be replaced immediately.
- Keep grease, oil and fuel off the tyres.
- Replace any missing valve caps as soon as possible.
- Mark the wheels before taking them off so that they rotate in the same direction when put back.
- When removed, the wheels or tyres should be stored in a cool, dry and preferably dark place.

New tyres

New tyres do not give maximum **grip** straight away and should therefore be “run in” by driving carefully and at moderate speeds for about the first 500 km (300 miles). This will also increase the useful life of the tyres.

The **tread depth** of new tyres may vary, according to the type and make of tyre and the tread pattern.

Low profile tyres

Low profile tyres, compared to other rim and tyre combinations, offer a broader tread and a greater rim diameter along with a lower height of the tyre sidewall. This results in a more agile driving behaviour. However, on roads that are in poor condition, this might affect comfort and cause more noise.

Low profile tyres may deteriorate more quickly than standard tyres, for instance due to strong knocks, potholes, manhole covers and kerbs. Therefore, maintaining the correct tyre pressure is particularly important >>> page 322.

To avoid damage to tyres and wheels, drive with special care when driving on roads in poor condition.

Visually inspect your tyres every 3,000 km regarding damage, e.g. flattening/cracks on the tyre sidewall or deformations/cracks on the rims. »

If the rims and tyres have received a heavy impact or have been damaged, have them checked and, if required, replaced at a specialised workshop.

Low profile tyres may deteriorate more quickly than standard tyres.

Concealed damage

Damage to tyres and rims is often not readily visible. If you notice unusual **vibration** or the car **pulling to one side**, this may indicate that one of the tyres is damaged. Reduce speed immediately if there is any reason to suspect that damage may have occurred. Inspect the tyres for damage. If no external damage is visible, drive slowly and carefully to the nearest specialised workshop and have the car inspected.

Tyres with directional tread pattern

An arrow on the tyre sidewall indicates the direction of rotation on single drive tyres. Always note the direction of rotation indicated when mounting the wheel. This guarantees optimum grip and helps to avoid aquaplaning, excessive noise and wear.

Retrofitting accessories

If you wish to change or fit wheels, rims or wheel trims, we recommend that you consult with a specialised CUPRA Service or

SEAT Official Service centre for advice regarding current technical recommendations.

Service life of tyres

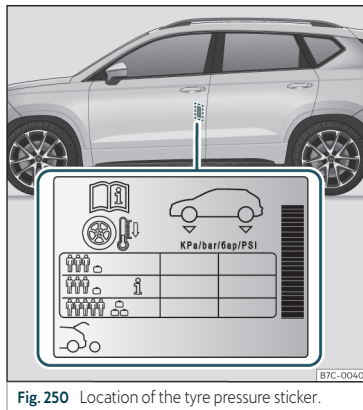

Fig. 250 Location of the tyre pressure sticker.

Correct inflation pressures and sensible driving habits will increase the useful life of your tyres.

- Check tyre pressure at least once a month, and also prior to any long trip.
- The tyre pressure should only be checked when the tyres are *cold*. Do not reduce the pressure of warm tyres.

- Adjust tyre pressure to the load being carried by the vehicle.
- In vehicles with a tyre pressure indicator, save the modified pressure of tyres >>> page 325, >>> page 322.
- Avoid fast cornering and hard acceleration.
- Inspect the tyres for irregular wear from time to time.

The useful life of your tyres depends on the following factors:

Tyre pressure

The tyre inflation pressures are listed on a sticker on the rear of the front left door frame >>> Fig. 250.

Insufficient or excessive pressure greatly reduces the useful life of the tyres and adversely affects vehicle performance and ride. Correct inflation pressures are very important, especially at **high speeds**.

Depending on the vehicle, tyre pressure can be adjusted to medium load to improve driving comfort (tyre pressure **i**). When driving with comfort tyre pressure fuel consumption may increase slightly.

The tyre pressure must be adjusted according to the load the vehicle is carrying. If the vehicle is going to carry the maximum load, the tyre pressure should be increased to the maximum value indicated on the sticker >>> Fig. 250.

Do not forget the spare wheel when checking the tyre pressures: Keep this spare wheel inflated to the highest pressure required for the road wheels.

In the case of a minimised temporary spare wheel (125/70 R18) inflate to a pressure of 4.2 bar as indicated on the tyre pressure label >>> **Fig. 250**.

Driving style

Fast cornering, heavy acceleration and hard braking (squealing tyres) all increase tyre wear.

Wheel balance

The wheels on new vehicles are balanced. However, certain circumstances may lead to imbalance (run-out), which is detected as vibrations in the steering wheel.

Unbalanced wheels should be rebalanced, as they otherwise cause excessive wear on steering, suspension and tyres. A wheel must also be rebalanced when a new tyre is fitted or if a tyre is repaired.

Incorrect wheel alignment

Incorrect running gear alignment causes excessive tyre wear, impairing the safety of the vehicle. If you notice excessive tyre wear, you should check wheel alignment at a specialised CUPRA Service or SEAT Official Service.

WARNING

- Always adapt the tyre pressure accordingly when the vehicle load changes.
- A tyre with low air pressure has to flex a lot more when the vehicle is heavily loaded or at high speeds, therefore causing overheating to occur. Under these conditions, the tyre bead may be released or the tyre may burst. Risk of accident!

For the sake of the environment

Under-inflated tyres will increase fuel consumption.

Wear indicators

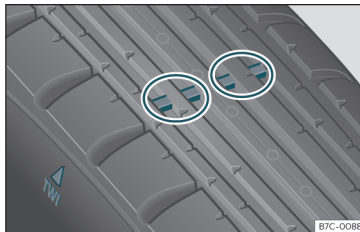

Fig. 251 Tyre profile: tread wear indicators.

Tread wear indicators indicate if a tyre is worn.

The original tyres on your vehicle have 1.6 mm high “tread wear indicators” running across the tread. Depending on the manufacturer, there will be 6 to 8 of them spaced at equal distances around the tyre. Markings on the tyre sidewall (for instance the letters “TWI” or a triangle) indicate the positions of the tread wear indicators.

The minimum tread depth required by law is 1.6 mm (measured in the tread grooves next to the tread wear indicators). (Different figures may apply in other countries.)

WARNING

The tyres must be replaced at the latest when the tread is worn down to the tread wear indicators. Failure to follow this instruction could result in an accident.

- Especially in difficult driving conditions such as wet or icy roads. It is important that the tyre tread be as deep as possible and be approximately the same on the tyres of both the front and the rear axles.
- The scant driving safety due to insufficient tread depth is particularly evident in vehicle handling, when there is a risk of “aquaplaning” in deep puddles of water and when driving through corners, and braking is also adversely affected.
- The speed has to be adapted accordingly, otherwise there is a risk of losing control over the vehicle.

Interchanging tyres

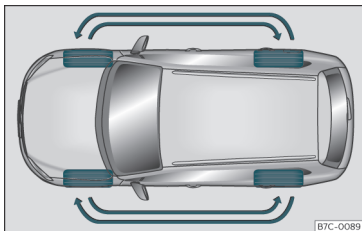

Fig. 252 Interchanging tyres.

To ensure that the wear is equal on all tyres the wheels should be changed round from time to time according to the system >>> Fig. 252. The useful life of all the tyres will then be about the same time.

New tyres or new wheels

- All four wheels must be fitted with tyres of the same type, size (rolling circumference) and preferably the same tread pattern.
- Tyres should be replaced at least in pairs and not individually (i.e. both front tyres or both rear tyres together).

- Do not use tyres whose effective size exceeds the dimensions of the factory-approved makes of tyre.
- If you wish to fit the vehicle with rims or tyres different to those installed in the factory, it is advisable to consult with a specialised CUPRA Service or SEAT Official Service **before** purchasing them.

The tyres and wheel rims are an essential part of the vehicle's design. The tyres and rims approved by CUPRA are specially matched to the characteristics of the vehicle and make a major contribution to good roadholding and safe handling >>> [△](#).

The sizes of the rims and tyres approved for your vehicle are listed in the vehicle documentation (e.g. EC Certificate of Conformity or COC document¹⁾). The vehicle documentation varies depending on the country of residence.

A knowledge of tyre designations makes it easier to choose the correct tyres. The following wording can be read on the sides of the tyre:

215/60 R16 95V

This contains the following information:

215	Tyre width in mm
-----	------------------

60	Height/width ratio in %
R	Tyre construction: Radial
16	Rim diameter in inches
95	Load rating code
V	Speed index

The **manufacturing date** is also indicated on the tyre sidewall (possibly only on the outer part):

DOT . . . 2216 . . .

it means, for example, that the tyre was manufactured in the 22nd week of 2016.

But note that with some types of tyre, the actual tyre size can differ from the nominal size marked on the tyre (for instance 215/60 R16 95 V), and there may be significant differences in the contours of the tyres, even though the tyres are marked with the same nominal size. When replacing the tyres, it is therefore important to make sure that the actual size of the new tyres does not exceed the dimensions of the factory-approved makes of tyre.

Failure to observe this requirement can affect the clearance needed for the tyres. If the tyres rub against the bodywork, in certain circumstances the tyres, running gear

¹⁾ COC = certificate of conformity.

or bodywork and pipes may be damaged, and vehicle safety could be severely impaired »» ⚠.

If you use tyres that are approved by CUPRA, you can be sure that the actual tyre dimensions will be correct for your vehicle. If you decide to fit a different type of tyre, you must obtain the appropriate manufacturer's certificate from the tyre retailer to confirm that the tyres are suitable for your vehicle. Keep this certificate in a safe place.

Your specialised CUPRA Service or SEAT Official Service will be able to advise you on which tyres may be fitted to your vehicle.

It is best to have all servicing of wheels and tyres performed by a **specialised workshop**. They are familiar with the procedure and have the necessary special tools and spare parts as well as the proper facilities for disposing of the old tyres respecting the environment.

⚠ WARNING

- It is very important to ensure that the tyres you have chosen have adequate clearance. When selecting replacement tyres, do not rely entirely on the nominal tyre size marked on the tyre, since the effective tyre size can differ significantly depending on the manufacturer. Inadequate tyre clearance can result in damage to the

tyres or the vehicle, causing a serious safety risk. Risk of accident! It may also invalidate the vehicle's registration for use on public roads.

- Avoid running the vehicle on tyres that are more than 6 years old. If you have no alternative, you should drive slowly and with extra care at all times.
- If wheel trims are fitted after the car is purchased, ensure that there is an adequate flow of air for cooling the brake system.

♻ For the sake of the environment

Old tyres must be disposed of according to the laws in the country concerned.

i Note

- A CUPRA Service Centre should be consulted to find out whether wheels or tyres of different sizes to those originally fitted by CUPRA can be fitted, and to find out about the combinations allowed between the front axle (axle 1) and the rear axle (axle 2).
- Never mount used tyres if you are not sure of their "previous history".
- For technical reasons, it is not generally possible to use the wheels from other vehicles. In some cases, this may also be true for the same model of wheel.

Wheel bolts

The **wheel bolts** are matched to the rims. When installing different wheels (for instance alloy wheels or wheels with winter tyres) it is important to use the correct wheel bolts with the right length and correctly shaped bolt heads. This ensures that wheels are fitted securely and that the brake system functions correctly.

The wheel bolts must be clean and turn easily.

A special adapter is required to turn the anti-theft wheel bolts* »»  page 48.

Tyre monitoring system

Introduction

⚠ WARNING

Unsuitable handling of the wheels and tyres may lead to sudden tyre pressure losses, to tread separation or even to a blow-out.

- Check tyre pressures regularly and ensure they are maintained at the pressures indicated. Tyre pressure that is too low could cause overheating, resulting in tread detachment or even burst tyres.

»

- Tyre pressure should be that indicated on the label when the tyres are cold at all times >>> page 345.
- Regularly check the cold inflation pressure of the tyres. If necessary, change the tyre pressure of the vehicle tyres while they are cold.
- Regularly check your tyres for damage and wear.
- Never exceed the maximum permitted speed or loads specified for the type of tyre fitted on your vehicle.

For the sake of the environment

Under-inflated tyres lead to increased fuel consumption and tyre wear.

Note

- Driving for the first time with new tyres at a high speed can cause them to slightly expand, which could then produce an air pressure warning.
- Only replace used tyres with those authorised by CUPRA for the corresponding type vehicle.
- Do not only rely on the tyre monitoring system. Regularly check your tyres to ensure that the tyre pressure is correct and that the tyres are not damaged due to puncture, cuts, tears and impacts/dents. Remove objects from the tyres only when they have not pierced the tyres.

Tyre control lamp

It lights up

The tyre pressure in one or more wheels has clearly gone down from the tyre pressure set by the driver or the tyre has structural damage. Additionally, an audible warning can be heard and a text message is displayed on the instrument panel display.

⚠ Stop the vehicle! Reduce speed immediately! Stop the vehicle safely as soon as possible. Avoid sudden manoeuvres and braking! Check all tyres and pressures. Replace any damaged tyres.

Flashes

Fault in the system.
The control lamp flashes for approximately one minute and then lights up permanently.
If tyre pressure is correct, switch the ignition off and on again. If the control lamp remains lit up, the tyre monitoring indicator can be calibrated. Have the system checked by a specialised workshop.

Several control and warning lamps light up for a few seconds when the ignition is switched on while the function is verified. They will switch off after a few seconds.

WARNING

When the tyres are inflated at different pressures or at a pressure that is too low then a tyre may be damaged resulting in a loss of control of the vehicle and a serious or fatal accident.

- If the warning lamp  lights up, stop immediately and check the tyres.
- If the tyres are inflated at different pressures or if a tyre pressure is too low, this will increase tyre wear, negatively affecting vehicle stability and increasing braking distances.
- If tyres are inflated at different pressures or a tyre pressure is too low, a tyre may be damaged and burst resulting in a loss of control of the vehicle.
- The driver is responsible for ensuring that all of the vehicle tyres are correctly inflated to the right pressure. The recommended tyre pressure is indicated on the label >>> page 345.
- The tyre monitoring system can only operate correctly if all of the tyres are inflated to the correct pressure when cold.
- Driving with tyres at the wrong pressure can damage them and result in an accident. Ensure that the tyre pressures of all the tyres correspond to the vehicle load.
- Before starting a journey, always inflate tyres to the correct pressure.
- Tyres with insufficient pressure are subjected to more flexing. Due to this, the tyre could become excessively hot, causing tread separation and also tyre blow-out.
- With an overloaded vehicle at high speed, the tyres can overheat and burst resulting in a loss of vehicle control.

- Tyre pressures which are too high or too low reduce the useful life of the tyre, affecting vehicle performance.
- If a tyre has not been punctured and it does not have to be changed immediately, drive to the nearest specialised workshop at a moderate speed and have the tyre checked and inflated to the correct pressure.

⚠ WARNING

Observe the safety warnings »»» ⚠ in Control and warning lamps on page 109.

📄 Note

- If excessively low tyre pressure is detected with the ignition on, an audible warning will sound. In the event that there is a fault in the system, an audible warning will sound.
- Driving on dirt tracks for a long period of time or driving in a sporty style can temporarily deactivate the TPMS. The control lamp shows a fault, but disappears when road conditions or the driving style change.

Tyre monitoring indicator

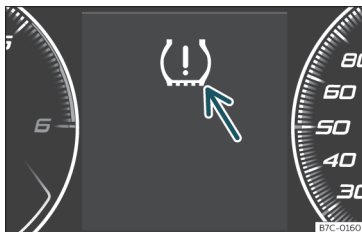

Fig. 253 Instrument panel: warning of loss of tyre pressure.

The tyre monitor indicator compares wheel revolutions and, with this information, the tread of each wheel using the ABS sensors. If the rolling circumference of one or more wheels has changed, the tyre monitoring indicator will indicate this on the instrument panel through a warning lamp and a warning to the driver »»» Fig. 253. When only one specific tyre is affected, its position within the vehicle will be indicated.

⚠ **Loss of pressure: Check left tyre pressure!**

Wheel tread change

The wheel tread changes when:

- Tyre pressure is manually changed
- Tyre pressure is insufficient

- Tyre structure is damaged
- The vehicle is unbalanced because of a load
- The wheels on an axle are subject to a heavier load (e.g. with a heavy load).
- The vehicle is fitted with snow chains
- The temporary spare wheel is fitted
- The wheel on one axle is changed

There may be a delay in the reaction of the tyre (⚠) monitoring indicator or it may not indicate anything under certain circumstances (e.g. sporty driving, snow-covered or unpaved roads, or when driving with snow chains).

Calibrating the tyre monitoring indicator

After changing the tyre pressure or replacing one or more wheels, the tyre monitoring indicator must be recalibrated. Do the same, for example, when the front and rear wheels are swapped.

- Switch the ignition on.

»

- Store the new tyre pressure in the Easy Connect¹⁾ system with the **(CAR)** > **SETTINGS** function button >>>  page 33.

- *In vehicles without a radio:* press and hold down the **(L)SET** button, with the ignition on, until an acoustic signal is heard.

When driving, the system self-calibrates the tyre pressure provided by the driver and the wheels fitted. After a long journey with varied speeds the programmed values are collected and monitored.

With the wheels under very heavy loads, the tyre pressure must be increased to the total recommended tyre pressure before the calibration >>> page 345.

Note

- **The tyre monitoring indicator does not function when there is a fault in the ESC or ABS >>> page 221.**
- **An erroneous indication may be given when snow chains are in use because they increase the tread of the wheel.**

¹⁾ In vehicles that are not equipped with the Easy Connect system, the switch for adjusting tyre pressure is located in the centre console next to the hazard warning lights.

Temporary spare wheel

General information

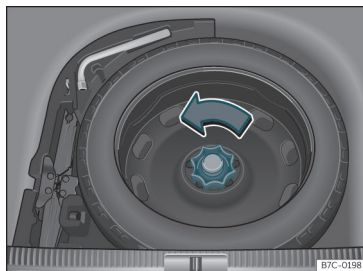

Fig. 254 Spare wheel: floor panel raised.

The temporary spare wheel has been designed to be used for short periods of time. Have the tyre checked and replaced as soon as possible at a specialised CUPRA Service, SEAT Official Service or at a specialised workshop.

Please note the following restrictions when using the compact temporary spare wheel. The compact temporary spare wheel is designed specifically for this model. For this

reason, do not use a temporary spare wheel from a different type of vehicle.

Removing the temporary spare wheel

- Lift and hold up the floor panel to remove the temporary spare wheel.
- Turn the thumb wheel anti-clockwise >>> **Fig. 254**.
- Take out the temporary spare wheel.

Chains

For technical reasons, snow chains must not be used on the temporary spare wheel.

If you have a puncture on one of the front wheels when using snow chains, fit the temporary spare wheel in place of one of the rear wheels. Fit the snow chains on the rear wheel that you have removed and replace the punctured front wheel with this wheel.

WARNING

- **After fitting the temporary spare wheel, check the tyre pressures as soon as possible. Failure to do so may cause an accident. The tyre pressure is listed on the back of the left front door frame >>> **Fig. 250**.**

- Do not drive at over 80 km/h (50 mph) when the temporary spare wheel is fitted on the vehicle: risk of accident!
- Never travel more than 200 km using a temporary spare wheel.
- Avoid heavy acceleration, hard braking and fast cornering: risk of accident!
- Never use more than one temporary spare wheel at the same time, risk of accident.
- No other type of tyre (normal summer or winter tyre) may be fitted on the compact temporary spare wheel rim.
- If you are driving using the spare wheel, the ACC system could automatically switch off during the journey. Switch off the system when starting off.

Getting the spare wheel out of vehicles with BEATS Audio 10 speakers (with subwoofer)*

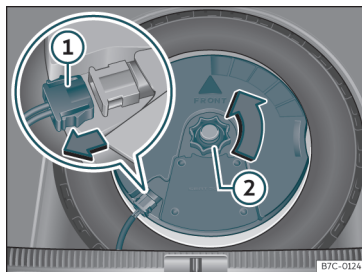

Fig. 255 In the boot: remove the subwoofer.

To remove the spare wheel, you must first remove the subwoofer.

- Lift and secure the luggage compartment floor as described in »» page 155.
- Disconnect the *subwoofer* »» Fig. 255 ① speaker cable.
- Turn the securing wheel in an anti-clockwise direction »» Fig. 255 ②.
- Remove the *subwoofer* speaker and the spare wheel.
- When re-mounting the spare tyre, place the *subwoofer* on the base of the wheel rim with care. When doing so, the tip of the

“FRONT” arrow on the *subwoofer* should point forward.

- Reconnect the speaker cable and firmly rotate the securing wheel clockwise so that the *subwoofer* system and wheel are firmly in place.

Winter service

Winter tyres

- Winter tyres must be fitted **on all four** wheels.
- Only use winter tyres that are approved for your vehicle.
- Please note that the maximum permissible speed for winter tyres may be lower than for summer tyres.
- Also note that winter tyres are no longer effective when the **tread** is worn down.
- After fitting the wheels you must always check the tyre pressures. When doing so, take into account the correct tyre pressures listed on the rear of the front left door frame »» page 322.

In winter road conditions winter tyres will considerably improve vehicle handling. The design of summer tyres (width, rubber compound, tread pattern) gives less grip on ice »»

and snow. This applies particularly to vehicles equipped with **wide section tyres** or with **high speed tyres** (code letters H, V or Y on the sidewall).

Only use winter tyres of the correct type approved for your vehicle. The sizes of these tyres are specified in the vehicle's documents (e.g. EC Certificate of Conformity or COC¹⁾). The vehicle documentation varies depending on the country of residence. See also >>> page 324.

Winter tyres lose a great deal of their properties when the **tread** is worn down to a depth of 4 mm.

The performance of winter tyres is also severely impaired by **ageing**, even if the tread is still much deeper than 4 mm.

Winter tyres are subject to the following **maximum speed limits** according to speed rating code letter: >>> 

Speed rating code letter >>> page 324	Maximum speed limit
Q	160 km/h (100 mph)
S	180 km/h (112 mph)
T	190 km/h (118 mph)

Speed rating code letter >>> page 324	Maximum speed limit
H	210 km/h (130 mph)
V	240 km/h (149 mph) (please note relevant restrictions)
W	270 km/h (168 mph)
Y	300 km/h (186 mph)

Vehicles capable of exceeding these speeds must have an appropriate **sticker** attached so that it is visible to the driver. Suitable stickers are available at specialised CUPRA Services, SEAT Official Service centres and specialised workshops. Please note the regulations to this effect in your country.

“All-weather” tyres can also be used instead of winter tyres.

Using winter tyres with V-rating

Please note that the generally applicable 240 km/h (149 mph) speed for winter tyres with the letter V is subject to **technical restrictions; the maximum permissible speed for your vehicle may be significantly lower**. The maximum speed limit for these tyres depends directly on the maximum axle weights for your car and on the listed weight rating of the tyres being used.

It is best to contact a specialised CUPRA Service or SEAT Official Service to check the maximum speed which is permissible for the V-rated tyres fitted on your car on the basis of this information.

WARNING

Exceeding the maximum speed permitted for the winter tyres fitted on your car can cause tyre failure, resulting in a loss of control of the vehicle – risk of accident.

For the sake of the environment

Summer tyres should be fitted again as soon as possible after the winter period; they give better handling on roads which are free of snow and ice. Summer tyres perform with less rolling noise, tyre wear and – most important – reduce fuel consumption.

¹⁾ COC = certificate of conformity.

Maintenance

Maintenance Programme

Service intervals

Servicing and Digital Maintenance Plan

Log of services performed (“Digital Maintenance Plan”)

Specialised CUPRA dealers, SEAT dealerships or a specialised workshop records Service receipts in a central system. Thanks to this comprehensive documentation of the service history, it is possible to reproduce the services performed any time. CUPRA recommends requesting a Service receipt after every service carried out containing all the services carried out on the system.

Whenever there is a new service the receipt is replaced with a current one.

The Digital Maintenance Plan is not available in some markets. In this case, your specialised CUPRA dealer or a SEAT dealership will inform you about the current documentation of the work.

Service works

In the Digital Maintenance Plan, your specialised CUPRA dealer, SEAT dealership or a specialised workshop will document the following information:

- When each one of the services was carried out.
- Whether a specific repair has been suggested, e.g. changing the brake pads in the near future.
- If you have expressed a special request for the maintenance. Your Service Advisor will write the work order.
- The components or fluids that were changed.
- The date of the next service.

The Long Life Mobility Warranty is valid until the next inspection. This information is documented in all checks performed.

The type and the volume of the service may vary from one vehicle to another. A specialised workshop will be able to provide specific information on the jobs for your vehicle.

WARNING

If the services are insufficient or not performed and if the service intervals are not observed, the vehicle may be immobilised in traffic cause an accident and severe injuries.

- Make sure that any repairs are carried out by a specialised CUPRA dealer, a SEAT dealership or a specialised workshop.

CAUTION

CUPRA cannot be held liable for any damage to the vehicle due to insufficient work or of lack of availability of spare parts.

Note

Regular services on the vehicle not only maintain its value, but also its correct operation and road safety. For this reason, conduct the services in accordance with CUPRA guidelines.

Fixed Service or Flexible Service

Services are classified as **oil change service** and **inspection**. The service interval display on the instrument panel display serves as a reminder of the next service.

Depending on the features, the engine and the conditions of use of the car, either the **Fixed service** or the **Flexible service** will be applied for an oil change service..

How to know which type of service needs to his vehicle

- Check the tables below: »

Oil change service^{a)}

PR No.	Type of service	Service interval
Q11	Fixed	Every 5000 km or after 1 year ^{b)}
Q12		Every 7500 km or after 1 year ^{b)}
Q13		Every 10000 km or after 1 year ^{b)}
Q14		Every 15000 km or after 1 year ^{b)}
Q16	Flexible	According to the service interval display

^{a)} The data are based on normal conditions of use.

^{b)} Whatever happens first.

Inspection Service^{a)}

According to the service interval display

^{a)} The data are based on normal conditions of use.

Bear in mind the information about the specifications of the engine oil according to the VW standard >>>  page 41.

Particular characteristics of the Flexible Service

Regarding the **Flexible Service**, the oil change service only has to be performed when the vehicle needs it. To calculate when

you have to carry out this service, take into account the individual conditions of use and personal driving style. A major component of the flexible service is the use of LongLife oil instead of conventional engine oil.

Bear in mind the information about the specifications of the engine oil according to the VW standard >>>  page 41.

If you do not want to the flexible service you can select the fixed service. However, a fixed service may affect service costs. The Service Advisor will gladly advise you.

Service intervals display

At CUPRA, the dates of the services are indicated by the service interval display on the instrument panel >>> page 106 or in the **Vehicle settings** menu of the infotainment system >>>  page 33. The service interval display gives information for service dates that involve an engine oil change or an inspection. When the time for the corresponding service comes, additional work required, such as the change of brake fluid and the spark plugs, can be carried out.

Information on the conditions of use

The service intervals and groups are usually based on **normal conditions of use**.

If, on the other hand, the vehicle is under **adverse conditions of use**, some of the work must be carried out before the next service period or even between service intervals.

Conditions of use adverse include:

- The use of fuel with a high sulphur content.
- Frequent short trips.
- Letting the engine idle for a long period of time, as in the case of taxis.
- Using the vehicle in areas with thick dust.
- Frequent driving with a trailer (depending on equipment).
- Using the vehicle mostly in situations with a lot of traffic and stops (e.g. in a city).
- Using the vehicle mostly in winter.

This applies especially for the following parts (depending on equipment):

- Dust and pollen filter
- Air Care allergen filter
- Air filter
- Toothed chain
- Particulate filter
- Engine oil

The Service Advisor of your specialised workshop will gladly inform you about the

need of performing service work between normal service intervals, always considering the conditions of use of your vehicle.

WARNING

If the services are insufficient or not performed and if the service intervals are not observed, the vehicle may be immobilised in traffic and cause accidents and severe injuries.

- Make sure that any repairs are carried out by a specialised CUPRA dealer, a SEAT dealership or a specialised workshop.

CAUTION

CUPRA cannot be held liable for any damage to the vehicle due to insufficient work or of lack of availability of spare parts.

Sets of services

Sets of services include all the **maintenance works** needed to ensure the safety and the smooth running of the vehicle (**depending on the conditions of use and the features of the vehicle**, such as the engine, gearbox, or operating fluids). Maintenance services are divided into *inspection* and *review* services. Consult the details of the jobs required for your vehicle at:

- Your CUPRA dealer

- Your SEAT dealership
- Your specialised workshop

Due to technical reasons (continuous development of components) the sets of services may vary. Your specialised CUPRA dealer, any SEAT dealership or a specialised workshop always receives updated information about any modifications that are made.

Additional service offers

Approved spare parts

Original SEAT Spare Parts have been conceived for their vehicles and approved by SEAT, with a special emphasis on safety. These parts correspond exactly to the manufacturer's requirements in terms of design, accuracy of the measurements and materials. The original SEAT Spare Parts have been conceived exclusively for your vehicle. For this reason, we always recommend the use of Original SEAT Spare Parts. SEAT cannot be held liable for the safety and suitability of parts from other manufacturers.

Approved spare parts

Approved spare parts, following the manufacturer's requirements, are an additional

service to you, offering the possibility of replacing complete sets, such as: light engine, gearboxes, heads, control units, electrical components, etc.

These parts are, **approved parts**, and are the same as the factory parts, which are also approved spare parts.

Original accessories

We recommend you only use CUPRA Original Accessories and CUPRA approved accessories for your vehicle. The reliability, safety and suitability of these accessories have been inspected specifically for this type of vehicle. CUPRA cannot be held liable for the safety and suitability of parts from other manufacturers.

Service Mobility

Since the moment you purchase your CUPRA vehicle you will be able to enjoy the benefits and coverage of the CUPRA Mobility Service.

For the first two years after the purchase, your new CUPRA vehicle is automatically covered by the CUPRA Mobility Service without additional costs. »

If you wish to enjoy this service after this period, you can extend the Mobility Service as long as you carry out the recommended Inspection and Maintenance Services at a specialised CUPRA Service or SEAT Official Service.

If your CUPRA vehicle is immobilised due to a fault or an accident, our assistance services will help you keep moving.

Take into account that the Mobility Service differs depending on the country where the vehicle was purchased. For further information, ask your specialised CUPRA dealer, any SEAT dealership or visit the CUPRA website in your country.

Warranty

Fault-free operation warranty

Specialised CUPRA Services or SEAT Official Services ensure the perfect condition of new vehicles. Check the purchase agreement or complementary additional documentation provided by your Technical Service to see the conditions and the terms of the warranty. Consult further information in this regard in your specialised CUPRA Service or SEAT Official Service.

Vehicle maintenance

Maintenance and cleaning

Basic considerations

Regular and careful care helps to maintain the value of your vehicle. In addition, it may become a prerequisite to demand the warranty in the event of corrosion damage and deficiencies in the paint coat of the bodywork.

Specialised workshops have the necessary care products. Please follow the instructions for application on the packaging.

WARNING

- Cleaning products and other materials used for car care can be damaging to your health if misused.
- Always keep care products in a safe place, out of the reach of children. Danger of poisoning!

For the sake of the environment

- When purchasing car care products, chose products that are compatible with the environment.
- The waste from car-care products should not be disposed of with ordinary household waste.

Washing the vehicle

The longer you take to clean the tanks, e.g. remains of insects, bird excrements, tree resin or anti frost salt adhered to your vehicle, the more damage it can cause to the surface. High temperatures, for instance strong sunlight, further intensify the damage.

Before washing the car, soften the dirt using plenty of water.

To remove encrusted dirt such as insects, bird droppings or tree resin, use a lot of water and a microfibre cloth.

Have the underside of the vehicle washed after the end of the anti frost salts in winter.

High pressure cleaners

When washing the vehicle with a high-pressure cleaner, always follow the operating instructions for the equipment. This applies particularly to the operating pressure and the distance between the spraying water. Do not aim the jet directly to the side window gaskets, doors, covers or the panoramic sunroof*; the same applies to tyres, rubber hoses, soundproofing material, sensors* or camera lenses*. Keep a distance of at least 40 cm.

Do not remove snow and ice with a high-pressure cleaner.

Do not use a nozzle that sprays the water out in a direct stream or one that has a rotating jet for forcing off dirt.

The water temperature must not exceed 60°C.

Automatic car wash tunnels

Spray the vehicle before starting the car wash.

Make sure that the windows and the panoramic sunroof* are closed and the wind-screen wipers are deactivated. Bear in mind the instructions of the car wash tunnel operator, especially if your vehicle has detachable parts.

Use of car washes without brushes if possible.

Washing by hand

Clean your vehicle from top to bottom with a soft sponge or with a brush. Only use cleaning products that do not contain solvents.

Washing vehicles with a matte paint by hand

To prevent damage to the vehicle when washing it, first remove the thicker dust and dirt. To remove traces of insects, grease and fingerprints, it is best to use a special cleaner for matte paint.

Apply the product with a microfibre cloth. To avoid damaging the surface of the paint, do not apply too much pressure.

Rinse with plenty of water. Then clean it with a neutral cleaning product and a soft microfibre cloth.

Rinse the vehicle again with plenty of water and then leave it to dry. Remove traces of water with a leather cloth.

WARNING

- Only wash the vehicle with the ignition switched off or according to the specifications of the car wash tunnel operator. Risk of accident!
- When cleaning the underbody or the inside of the wheel arches, protect yourself from sharp or pointy metal parts. Risk of cut!
- After cleaning the brakes could act more slowly due to moisture or, in winter, the ice on the brake discs and pads. Risk of accident! In this case the brakes should be dried by pressing the brake pedal several times.

CAUTION

- Before washing the vehicle in an automatic car wash, please make sure to retract the exterior mirrors to prevent them from being damaged. Electric exterior rearview

mirrors must always be folded/deployed electrically!

- Do not wash the vehicle in direct sunlight. Risk of damaging the paint job!
- Do not use sponges, abrasive household sponges or similar to clean insect remains. Risk of damaging the surface!
- Vehicle parts with matte paint:
 - Do not use polish or hard wax. Risk of damaging the surface!
 - Never select washing programs that include the use of wax. This could damage the appearance of matte paint.
 - Do not put stickers or magnets on parts with matte paint, as removing them may damage the paint.

For the sake of the environment

The car should only be washed in special wash bays. These places are prepared to prevent oily water from getting into the public drains.

Cleaning and maintenance instructions

The cleaning and maintenance of individual components of the vehicle can be checked in the following tables. The contents should be understood merely as a recommendation. Go to your specialised workshop if you »

have special questions or parts that are not listed. Take the general considerations into account >>> **△** in Take special care with... on page 339.

Exterior cleaning

Windscreen wipers

Problem	Solution
Dirt	Soft cloth with wipers

Headlights / Tail lights

Problem	Solution
Dirt	Soft sponge with neutral soap solution ^{a)}

^{a)} Neutral soap solution: two tablespoons maximum in 1 litre of water

Sensors / Camera lenses

Problem	Solution
Dirt	<i>Sensors</i> : soft cloth with cleaning product which does not contain solvents <i>Camera lenses</i> - soft cloth with cleaning product with no alcohol content
Snow/ice	Hand brush/Anti frost spray with no solvents

Wheels

Problem	Solution
Anti frost salt	Water
Brake abrasion dust	Acid-free special cleaning product

End exhausts

Problem	Solution
Anti frost salt	Water, if a steel cleaning product is required

Covers / Trims

Problem	Solution
Dirt	Neutral soap solution ^{a)} , if a steel cleaning product is required

^{a)} Neutral soap solution: two tablespoons maximum in 1 litre of water

Paint

Problem	Solution
Flaws in the paint	Check the paint's colour code in an authorised service and re-store with a touch-up pencil
Spilled fuel	Immediately rinse with water
Environmental rust tank	Apply rust remover and then apply hard wax. Go to your specialised workshop if you have any queries

Problem	Solution
Corrosion	Have your specialised workshop take care of this
The water does not create droplets on the clean paint	Maintain with hard wax (at least 2 times a year)
No shine despite sober maintenance/paint	Treat with suitable wax and apply paint preservative afterwards if the wax used does not contain preservative ingredients
Tanks, e.g. insect remains, bird droppings, tree sap, road salt	Immediately soften with water and remove with a microfibre cloth
Fat-based dirt, e.g. cosmetic products or sunscreen	Delete immediately with a neutral soap solution ^{a)} and a soft cloth

^{a)} Neutral soap solution: two tablespoons maximum in 1 litre of water

Carbon fibre parts

Problem	Solution
Dirt	Clean the same way as painted parts >>> page 334

Decoration slides

Problem	Solution
Dirt	Soft sponge with neutral soap solution ^{a)}

^{a)} Neutral soap solution: two tablespoons maximum in 1 litre of water

Interior cleaning

Windows

Problem	Solution
Dirt	Apply windscreen cleaner and then dry with a cloth

Covers / Trims

Problem	Solution
Dirt	Neutral soap solution ^{a)}

^{a)} Neutral soap solution: two tablespoons maximum in 1 litre of water

Plastic parts

Problem	Solution
Dirt	Damp cloth
Encrusted dirt	Neutral soap solution ^{a)} , if possible solvent-free plastic cleaner

^{a)} Neutral soap solution: two tablespoons maximum in 1 litre of water

Displays/instrument panel

Problem	Solution
Dirt	Soft cloth with a liquid crystal display cleaner

Control panels

Problem	Solution
Dirt	Soft brush, then soft cloth with neutral soap solution ^{a)}

^{a)} Neutral soap solution: two tablespoons maximum in 1 litre of water

Seat belts

Problem	Solution
Dirt	Neutral soap solution ^{a)} , allowed to dry before retracting

^{a)} Neutral soap solution: two tablespoons maximum in 1 litre of water

Fabrics, artificial, Alcantara leather

Problem	Solution
Dirt particles adhered to the surface	Vacuum cleaner
Water-based dirt, e.g. coffee, tea, blood etc.	Absorbent cloth and neutral soap solution ^{a)}

Problem	Solution
Grease-based dirt, e.g. oil, make-up, etc.	Apply a neutral soap solution ^{a)} . Absorb the dissolved grease and paint particles drying with an absorbent cloth, in case you must treat it with water afterwards
Special dirt, e.g. pens, nail polish, dispersion paint, shoe cream etc.	Special stain remove: dry with an absorbent cloth, if applicable, apply neutral soap solution afterwards ^{a)}

^{a)} Neutral soap solution: two tablespoons maximum in 1 litre of water

Natural leather

Problem	Solution
Recent dirt	Cotton cloth with neutral soap solution ^{a)}
Water-based dirt, e.g. coffee, tea, blood etc.	Recent stains: absorbent cloth Dry stains: leather cleaner
Grease-based dirt, e.g. oil, make-up, etc.	Recent stains: absorbent cloth and leather cleaner Dry stains: grease dissolving spray
Special dirt, e.g. pens, nail polish, dispersion paint, shoe cream etc.	Stain remover suitable for leather

»

Problem	Solution
Care	Apply preservative cream regularly to protect from sunlight. Use a colour preservative if required

a) Neutral soap solution: two tablespoons maximum in 1 litre of water

Carbon fibre parts

Problem	Solution
Dirt	Clean like plastic parts

Take special care with...

Headlights/tail lights

- Do not clean the headlights/tail lights with a dry cloth or sponge.
- Do not use cleaning products that contain alcohol. Risk of cracks!

Wheels

- Do not use for paint wax or other abrasive products.
- If the protective coating on the paint of the rim has been damaged due to stone impacts, scratches, etc., the damage should be repaired immediately.

Camera lenses

- Do not use hot or warm water to remove ice or snow from the camera lenses. Risk of cracking the lens!
- To clean the camera lens, never use abrasive cleaning products or products with alcohol. Risk of scratches and cracks!

Windows

- Remove snow and ice from windows and exterior mirrors with a plastic scraper only. To avoid scratches, the scraper should only be pushed in one direction and not moved to and fro.
- Never remove snow or ice from windows and rearview mirrors with warm or hot water. Risk of cracks on the windows!
- To prevent damage to the heating of the rear window, do not put stickers over the heating elements.

Covers/trims

- Do not use cleaning products or chrome based cleaning agents.

Paint

- The vehicle must be free from dirt and dust before applying wax or care products. Risk of scratches!
- Do not apply wax or care products if the vehicle is exposed to direct sunlight. Risk of damaging the paint job!

- The ambient rust deposits must not be removed through friction. Risk of damaging the paint job!
- Remove cosmetic products and sunlight immediately. Risk of damaging the paint job!

Displays/instrument panel

- The screens, the instrument panel and the trim around it must not be cleaned dry. Risk of scratches!
- Make sure that the instrument panel is switched off and cooled down before cleaning.
- Make sure that no liquid leaks between the instrument panel and the trim. Risk of damage!

Control panels

- Make sure that no liquid leaks into the control panels. Risk of damage!

Seat belts

- Do not remove the seat belts to clean them.
- Seat belts and their components must never be cleaned with chemical products, nor should they be allowed to come into contact with corrosive liquids, solvents or sharp objects. Risk of damaging the fabric!
- If you find any damage to the belt webbing, belt fittings, the belt retractor or the buckle, ask your specialised workshop to replace the belt in question.

Fabrics/artificial leather/Alcantara leather

- Do not treat artificial leather/Alcantara leather with leather cleaning products, solvents, wax polish, shoe cream, stain removers or similar products.
- If the stain is very hard to remove, take the vehicle to a specialised workshop to have it removed there. This will prevent damage.
- Do not use steam cleaners, brushes, hard sponges, etc. to clean.
- Do not turn on seat heating* to dry the seats.
- Sharp objects on clothing, such as zips, rivets or belts can damage the surface.
- Open Velcro, e.g. on clothes can damage the seat upholstery. Make sure that Velcro fasteners are closed.

Natural leather

- Never use solvents, wax polish, shoe cream, spot removers or similar products on leather.
- Sharp objects on clothing, such as zips, rivets or belts can damage the surface.
- Do not use steam cleaners, brushes, hard sponges, etc. to clean.
- Do not turn on seat heating* to dry the seats.
- Avoid exposing leather to direct sunlight for long periods, otherwise it may tend to

lose some of its colour. If the car is left for a prolonged period in the bright sun, it is best to cover the leather.

WARNING

Do not use water-repellent coatings on the windscreen. In bad visibility conditions such as humid weather, darkness or when the sun is in its lowest point, visibility may be impacted. Risk of accident! Such coatings can also cause the windscreen wiper blades to make noise.

Note

- Remains of insects can be removed much more easily with previously treated paint.
- Regular car care treatments can prevent deposits of ambient rust.

Remove the vehicle from traffic

If you want to leave your vehicle stationary for a long period of time, contact a qualified workshop. They will gladly inform you about the necessary measures, such as anti-corrosion protection, Service and storage.

Also take into account instructions regarding the vehicle's battery >>> page 318.

Information for the user

Event Data Recorder

Description and operation

Your vehicle has an event data recorder (EDR).

The EDR's function is to record data in the event of a mild or serious accident. These data are used to support the analysis of how different vehicle systems behaved.

The EDR records, over a reduced time range (normally 10 seconds or less), dynamic driving data and data from the restraint systems, such as:

- How different vehicle systems worked.
- Whether the driver and the occupants were wearing their seat belts.
- How hard the acceleration or brake pedal was pressed.
- Vehicle speed.

These data will provide a better understanding of the circumstances of the accident.

Data from the driving assist systems are also recorded. This includes data such as whether the systems were inactive or active and if such action had an impact on the vehicle's dynamic behaviour, changing its path in the

aforementioned situations, accelerating or decelerating the vehicle.

Depending on vehicle equipment, this includes data from systems such as:

- Adaptive Cruise Control (ACC)
- Emergency braking assistance system (Front Assist).
- Park Pilot system
- Parking aid system (Park Assist).
- Lane Assist

The EDR data are only recorded in specific accident situations. No data are recorded in normal driving conditions.

No audio or video data inside or around the vehicle are recorded. Under no circumstances are personal data such as name, age, or gender recorded. Nevertheless, third parties (such as criminal proceedings authorities) may relate the contents of the EDR data to other data sources and create a personal reference in the context of an accident investigation.

In order to read the EDR data it is necessary to access (if legally permitted to do so) the vehicle's ODB ("On-Board-Diagnose") interface while the vehicle is switched on.

CUPRA will not have access to EDR data unless the owner (or, in "Leasing" cases, the lessee or hirer) gives their consent. There

may be exceptions to this, depending on legal or contractual provisions.

Due to legal requirements in safety-related products, CUPRA may use the EDR data for field research and in order to improve vehicle system quality. Any data used for the purposes of research will be treated anonymously (in other words, no reference will be made to the vehicle, their owner or the lessee/hirer).

Information about the EU Directive 2014/53/EU

Simplified EU compliance declaration

Your vehicle has different radioelectrical devices. The manufacturers of these devices declare that they comply with Directive 2014/53/EU when legally required.

The full text of the EU compliance declaration is available online at the following address:

www.cupraofficial.com



Table of correspondences

The table of correspondences will help you to associate the name of the device in the declaration of compliance with the features of the vehicle and the terminology used in the on-board documentation.

Features of the vehicle	Name of the device according to the declaration of compliance
Radiofrequency remote control (vehicle)	FS12A, FS12P

Features of the vehicle	Name of the device according to the declaration of compliance
Radio frequency remote control (auxiliary heater)	Sender STH SEAT - 50000914
Auxiliary heating	50000864 / D208L VW
Bluetooth	MIB2 Main-Unit A580 / A270
Wireless hotspot	MIB2 Main-Unit A580 / A270
Keyless Access System	MQB-B B
Radar sensors for assistance systems	ARS4-B BSD3.0
Central control unit	5WK50254 5WK50474
Infotainment system	MIB2 Main-Unit A580 / A270
Wireless charging	WCH-183
Connection to the external antenna of the car	UMTS/GSM-MMC-AG2
Instrument panel	Immobilizer integrated in dashboard module instrument cluster

Features of the vehicle	Name of the device according to the declaration of compliance
Antenna	5Q0.035.507 Roof Antenna 8S7.035.503.B
Antenna amplifiers	575.035.225 575.035.225.A 575.035.225.B

Addresses of the manufacturers

According to the Directive 2014/53/EU, all relevant components must include the address of the manufacturer.

The address of the manufacturers of components that, due to their size or nature, cannot include a sticker are listed below, as long as it is legally required:

Radioelectrical equipment fitted in the vehicle	Addresses of the manufacturers
Radiofrequency remote control key	Hella KGaA Hueck & Co. Rixbecker Straße 75 59552 Lippstadt, GERMANY
Radio frequency remote control (auxiliary heater)	Digades gmbh Äußere Weberstraße 20 02763 Zittau, GERMANY
Radar sensors for assistance systems	ADC Automotive Distance Control Systems GmbH Peter-Dornier-Straße 10 88131 Lindau, GERMANY

Frequency bands, station power

Radioelectrical equipment ^{†3)}	Frequency band	Max. station power
Radiofrequency remote control (vehicle)	433.05-434.78 MHz	10 mW (ERP)
	433.05-434.79 MHz	10 mW
	868.0-868.6 MHz	25 mW
	434.42 MHz	32 µW
Radio frequency remote control (auxiliary heater)	868.7-869.2 MHz (869.0 MHz)	0.24 mW, / -6.3 dBm e.r.p.
Auxiliary heating	868.7-869.2 MHz (869.0 MHz)	23.5 mW, / 13.7 dBm e.r.p.
Bluetooth	2400-2483.5 MHz	10 dBm
Wireless hotspot	2400-2483.5 MHz	10 dBm

Information about the EU Directive 2014/53/EU

Radioelectrical equipment ^{a)}	Frequency band	Max. station power
Connection to the external antenna of the car	GSM 900: 880-915 MHz	33 dBm
	GSM 1800: 1710-1785 MHz	30 dBm
	WCDMA FDD I: 1920-1980 MHz	24 dBm
	WCDMA FDD III: 1710-1785 MHz	24 dBm
Keyless Access	434.42 MHz	32 μ W
Radar sensors for assistance systems	76 GHz-77 GHz	35.0 dBm
	24050-24250 MHz	20 dBm
Wireless charging	110-120 kHz	10 W
Instrument panel	125 kHz	40 dB μ A/m

a) The commissioning or authorisation of radioelectrical technology may be restricted in some European countries, forbidden or only allowed with additional requirements.

Technical data

Technical specifications

Important

The information in the vehicle documentation always takes precedence over the information in this Instruction Manual.

All technical specifications provided in this documentation are valid for the standard model in Spain.

The figures may be different depending whether additional equipment is fitted, for different models, for special vehicles and for other countries.

Abbreviations used in the Technical Specifications section

kW	Kilowatt, engine power measurement.
PS	Pferdestärke (horsepower), formerly used to denote engine power.
rpm, 1/min	Revolutions per minute - engine speed.
Nm	Newton metres, unit of engine torque.
CZ	Cetane number, indication of the diesel combustion power.
RON	Research octane number, indication of the knock resistance of petrol.

Vehicle identification data



Fig. 256 Chassis number.

VIN in the Easy Connect

- Select: **CAR** button > **SETTINGS** > **Service** > **Chassis number**.

Chassis number

The VIN is located in the Easy Connect and under the windscreen, on the driver side >>> Fig. 256. Also the VIN is located in the engine compartment, on the left-hand side in the direction of travel. The number is engraved on the top side rail, and is partially covered.

Type plate

The type plate is located on the right side door pillar. Vehicles for certain export countries do not have a type plate.

Identifying letters

The identifying letters of the engine can be viewed on the instrument panel when the engine is switched off and the ignition is on.

- Hold down the button **0.0/SET** on the dash panel for more than 15 seconds.

Information on fuel consumption

Fuel consumption

Approved consumption values are derived from measurements performed or supervised by certified EU laboratories, according to the legislation in force at the time (for more information, see the Publications Office of the European Union on the EUR-Lex website: © European Union, <http://eur-lex.europa.eu/>) and apply to the specified vehicle characteristics.

The values relating to fuel consumption and CO₂ emissions can be found in the documentation provided to the purchaser of the vehicle at the time of purchase.

Fuel consumption and CO₂ emissions depend on the equipment/features of each individual vehicle, as well as on the driving

style, road conditions, traffic conditions, environmental conditions, load or number of passengers.

Note

In practice, and considering all the factors mentioned here, consumption values can differ from those calculated in the current European regulations.

Weights

Kerb weight refers to the basic model with a fuel tank filled to 90% capacity and without optional extras. The figure quoted includes 75 kg to allow for the weight of the driver.

Special versions, optional equipment fittings or retro-fitting accessories will increase the weight of the vehicle >>> .

WARNING

- Please note that the centre of gravity may shift when transporting heavy objects; this may affect vehicle handling and lead to an accident. Always adjust your speed and driving style to suit road conditions and requirements.
- Never exceed the gross axle weight rating or the gross vehicle weight rating. If the permissible axle load or the permissible total weight is exceeded, the driving characteristics of the vehicle may change, which

could lead to accidents, injuries and damage to the vehicle.

Trailer mode

Trailer weights

Trailer weight

The trailer weights and drawbar loads approved are selected in intensive trials according to precisely defined criteria. The approved trailer weights are valid for vehicles in the EU for maximum speeds of 80 km/h (50 mph) (in certain circumstances up to 100 km/h (62 mph)). The figures may be different in other countries. All data in the official vehicle documentation takes precedence over these data at all times >>> .

Drawbar loads

The *maximum* permitted drawbar load on the ball coupling of the towing bracket must not exceed **88 kg**.

In the interest of road safety, we recommend that you always tow approaching the maximum drawbar load. The response of the trailer on the road will be poor, if the drawbar load is too small.

If the maximum permissible drawbar load cannot be met (e.g. with small, empty and

light-weight single axle trailers or tandem axle trailers with a wheelbase of less than 1 metre), a minimum of 4% of the actual trailer weight is legally required for the drawbar load.

WARNING

- For safety reasons, you should not drive at speeds above 80 km/h (50 mph) when towing a trailer. This also applies in countries where higher speeds are permitted.
- Never exceed the maximum trailer weights or the drawbar load. If the permissible axle load or the permissible total weight is exceeded, the driving characteristics of the vehicle may change, leading to accidents, injuries and damage to the vehicle.

Wheels

Tyre pressure, snow chains and wheel bolts

Tyre pressure

The sticker with the tyre pressure values can be found on the back of the left front door frame. The tyre pressure values given there are for *cold* tyres. The slightly raised pressures of warm tyres must not be reduced.

>>> 

>>

The pressure for *winter* tyres is 0.2 bar (2.9 psi / 20 kPa) higher than that of summer tyres.

Snow chains

Snow chains may be fitted only to the front wheels, and only for the following tyres:

225/50 R18	Chains with links of maximum 9 mm
------------	-----------------------------------

225/45 R19	Chains with links of maximum 9 mm
------------	-----------------------------------

Other dimensions do not allow chains	
--------------------------------------	--

Wheel bolts

After the wheels have been changed, the **tightening torque** of the wheel bolts should be checked as soon as possible with a torque wrench »» . Rim torque is **140 Nm**.

WARNING

- Check the tyre pressure at least once per month. Checking the tyre pressure is very important. If the tyre pressure is too high or too low, there is an increased danger of accidents - particularly at high speeds.

- If the tightening torque of the wheel bolts is too low, they could loosen while the vehicle is in motion. Risk of accident! If the tightening torque is too high, the wheel bolts and threads can be damaged.

Note

We recommend that you ask your Technical Service for information about appropriate wheel, tyre and snow chain size.

Engine data

Petrol engines

	2.0 TSI Start-Stop
Power output in kW (PS) at 1/min	221 (300)/5,300-6,500
Maximum torque (Nm at 1/min)	400/2,000-5,200
No. of cylinders/displacement (cm ³)	4/1,984
Fuel	Super 98 RON / Super 95 (with a slight power loss) RON
Gearbox	DSG 4Drive
Top speed (km/h)	245 (6)
Acceleration from 0-80 km/h (seconds)	3.6
Acceleration from 0-100 km/h (seconds)	5.4
Maximum authorised weight (kg)	2,150
Weight in running order (with driver) (kg)	1,632
Maximum authorised weight on front axle (kg)	a)
Maximum authorised weight on rear axle (kg)	a)
Maximum trailer weight without brakes (kg)	750
Weight of trailer with brakes on gradients up to 8% (kg)	2,100
Weight of trailer with brakes on gradients up to 12% (kg)	2,100

a) Data not available as this edition goes to print.

Dimensions

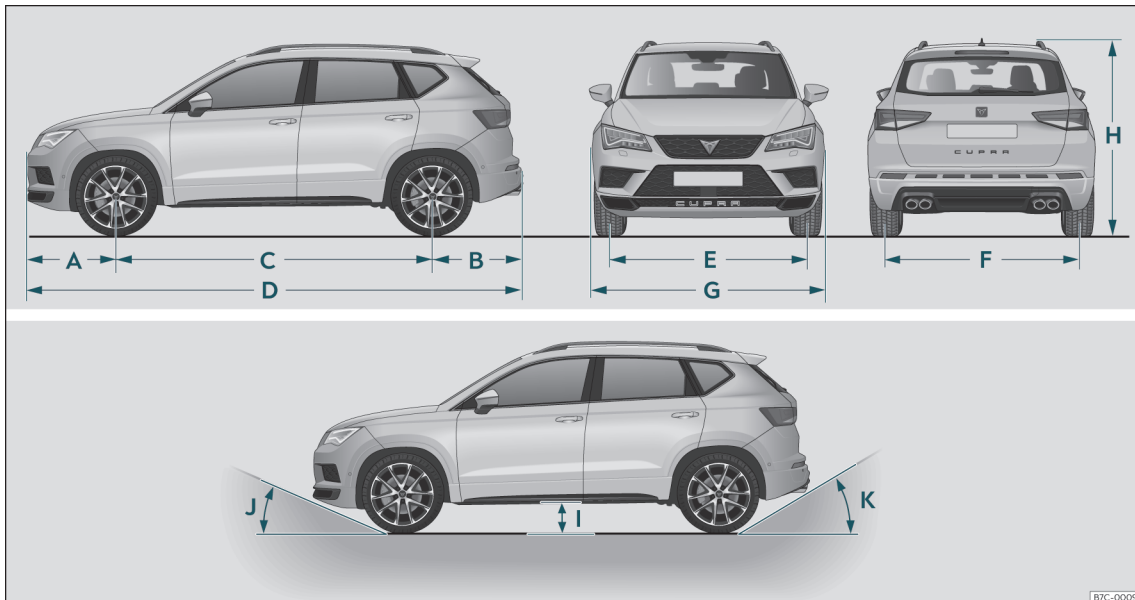

Fig. 257 Dimensions and angles.

B7C-0009

Technical specifications

»» Fig. 257		Ateca 4Drive
A	Front projection (mm)	868
B	Rear projection (mm)	865
C	Wheelbase (mm)	2,630
D	Length (mm)	4,363
E	Front track (mm)	1,572
F	Back track (mm)	1,544
G	Width (mm)	1,841
H	Height at kerb weight (mm)	1,611 ^{a)} 1,625 ^{b)}
I	Ground clearance between the axles (mm)	189
J	Front projection angle limited by the bumper	maximum 20.6°
K	Rear projection angle limited by the bumper	maximum 25.5°
	Turning radius (m)	10.8

a) Distance to the roof.

b) Dimension to the roof bars.

Index

Numbers and Symbols

4Drive 237

A

ABS

see Anti-lock brake system 221

ACC 251

radar sensor 253

Accessories 149, 307

Adaptive cruise control 251

Adaptive Cruise Control

control and warning lamps 252

deactivating temporarily 257

function for preventing overtaking in an
inside lane 257

instructions on the screen 253

malfunction 252

operating 254

radar sensor 253

special driving situations 258

Adjust

Vehicle menu 33

Adjusting

front head restraints 60

front seats 143

lights 138

rear head restraints 144

seats 57

Adjusting the head restraints

front head restraints 144

Adjustment

front head restraints 144

rear head restraints 61

Airbag covers 21

Airbags 68

Airbag system 21, 68

activation 69

control lamp 73

deactivation of front airbag 72

description 68

front airbags 21, 70

functioning 69

head-protection airbags 24

knee airbags 23

side airbags 23

Air conditioning

Climatronic 39, 158

heated windshield 162

user instructions 160

Air outlets 161

Air recirculation 161

Alcantara leather: cleaning 337

Alternator

warning lamp 319

AM 182

Ambient lighting 138

Android Auto™ 175, 177

Anti-freeze 42

Anti-lock brake system 221

Anti-puncture 47, 78

Anti-puncture kit 47, 78

check after 10 minutes 80

Anti-puncture set 78

Anti-slip regulation 221

Anti-theft alarm 112, 121

trailer 302

vehicle interior monitoring and anti-tow

protection 123

Anti-theft security system 15, 112, 120

Anti-theft system

trailer 302

Anti-tow protection 123

Anti-trap function

sun blind (sunroof) 131

sunroof 131

App

Media Control 179

Apple CarPlay™ 175, 177

Area view system (Top View Camera)

special characteristics 292

Aspects to note before setting off 56

Assistance systems

ACC 251

Adaptive cruise control 251

Auto Hold function 241

blind spot detector (BSD) with parking as-

sistance (RCTA) 265

cruise control system 242

disable 109

Emergency Assist 264

emergency braking assistance (Front As-

sist) 247

enable 109

fatigue detection 100

Hill Descent Control 240

Park Assist 273

parking assistant (RCTA) 265

parking system Plus 283

rear parking aid 287

- speed limiter 243
- Top View Camera 289
- traffic jam assist 263
- traffic sign detection system 102
- tyre monitoring 326
- tyre monitoring indicator 327
- tyre monitoring system 325
- Assisted starting 52
- Audible warning signal
 - control and warning lamps 109
 - lights 132
 - unfastened safety belt 62
- Auto Hold 241
- Auto Hold function 241
- Auto Lock (central locking) 112
- Automatic
 - transmission 38
- Automatic car washes
 - switching the Auto Hold function off 242
- Automatic car wash tunnel 335
- Automatic dipped beam control 133
- Automatic gearbox 224
 - downhill speed control 230
 - driving tips 228
 - emergency program 230
 - kick-down feature 229
 - launch control program 229
 - manual release of the selector lever 38
 - selector lever lock 226
 - selector lever positions 225
 - steering wheel with the gear shift paddles 227
 - tiptronic 224, 227
- Automatic transmission
 - control lamp 225
 - towing 82
- AUX-IN 212
 - external audio source 188
- Average consumption 95
- B**
- Battery 120
- Before setting off 56
- Belt tensioners
 - control lamp 73
- Belt tightening 66
- Bench seat 146
- Bicycle rack
 - fitting on the retractable tow hitch 300
 - maximum load 300
- Blind spot detector (BSD) 265, 266
 - control lamps 266
 - driving situations 269
 - indication in the external rear view mirror 267
 - malfunction 266
 - operating 267
 - towing 271
- Bluetooth®
 - connect audio source 188
- Bonnet 310, 313
 - opening and closing 17, 311
- Boot shelf
 - store 152
 - store the shelf 152
- Brake fluid 43
- Brakes 217
 - brake fluid 317
 - brake servo 217
 - electronic parking brake 219
 - emergency braking function 220
 - new brake pads 217
- Brake system
 - warning lamp 218
- Braking
 - front assist 221
- BSD
 - see Blind spot detector (BSD) 265
- BSD Plus 262
- C**
- Camera
 - cleanliness 104
 - Lane Assist 260
- Capacities 41
 - windscreen washer water 318
- CCS 37
- CD-ROM player (navigation) 148
- Central locking 112
 - adjustment 114
 - anti-theft alarm 121
 - central locking switch 115
 - electric windows 127
 - emergency locking 16
 - Keyless Access 116
 - Panoramic sliding/tilting sunroof 127
 - remote control key 114
 - selective unlocking system 114
- Centre console 13
- Changing a wheel 48
 - subsequent work 50
- Changing bulbs 89
 - number plate light 91
 - rear bulb in the side panel 89
 - rear light in the rear lid 90
- Changing the blades 81
- Changing the wiper blades 54

Index

Charging the battery	320	Climatronic	39	EDS	221
Checking levels		Clocks		electromechanical steering	231
engine compartment	313	digital	104	engine oil	314
Child-proof locking		set time	104	ESC	221
electric windows	126	Close		gear change	231
Child seat	24, 75	sunroof	129	handbrake	218
Child seats		Closing	112	Hill Descent Control	240
categorisation into groups	75	bonnet	17, 311	instrument panel	36
ISOFIX system	26	rear lid	124	Lane Assist	260
safety instructions	24, 74	sun blind (sunroof)	130	lights	132
securing with seat belt	25	sunroof	129	parking assistant (RCTA)	266
Top Tether system	26, 29	windows	126	refuelling	308
Cleaning		Clutch (warning lamp)	230	seat belt	62
Alcantara leather	337	Coming Home	135	speed limiter	243
carbon fibre	336, 338	Coming Home function	135	Start-Stop	238
control panels	337	Communication between the Infotainment		steering column locking	231
decorative sheets	337	system and mobile devices	172	tow hitch	300
exhaust tail pipes	336	Connectivity	172	towing bracket	298
exterior	336	Full Link	172	transmission	225
fabrics	337	Media Control	179	tyre monitoring system	326
headlights / tail lights	336	WLAN point of access	180	Control and warning lights	
high pressure cleaners	334	Connectivity Box	212	emission control	236
Interior	337	Control and warning lamps	36, 109	engine management	236
leather	337	ABS anti-blocking system	221	ESC	223
paint	336	adaptive cruise control	252	Control lamps	
plastic parts	337	airbags	72	engine coolant	106
seat belts	337	airbag system	73	Fuel reserve	105
sensors/camera lenses	336	alternator	319	refuel	105
special care	338	applying the brake	252	Controls and displays	
the radio screen	337	ASR	221	general instrument panel	93
trims/covers	336, 337	audible warning signal	109	Controls for the windows	18, 126
washing the vehicle	334	blind spot detector (BSD)	266	Controls on the steering wheel	110
wheels	336	brake systems	218	Coolant	
windows	337	cruise control system (CCS)	242	checking level	316
windscreen wipers	336	depress the brake	247		

- Cooling system
 checking coolant 316
 topping up coolant 316
- Copyright 184
- Correct position 57
- Correct sitting position
 driver 57
 front passenger 58
 rear seat passengers 59
- Cruise control 37, 242
 control and warning lamps 242
 operation 242
- Cruise control system 242
- D**
- DAB 182
- Dangers in not using the seat belt 64
- Dashboard 94
- Dash panel 36
- Data label 344
- Data transfer 172
- Deactivating the front passenger front airbag 22
- Deactivation of front airbag 72
- Defective bulbs
 changing bulbs 89
- Diesel
 engine oil 313
- Digital Cockpit 95
 information profiles 95
 navigation map 96
- Digital instrument
 panel (Digital Cockpit) 95
- Dimensions 348
- Direction of rotation
 tyres 50
- Display indications
 compass indications 97
 driving recommendation 97
 instrument panel 96
 speed limiter 244
 time 104
- Display of traffic signs on the instrument
 panel
 activate 102
 deactivate 102
- Disposal
 belt tensioners 67
- Distance control
 see Adaptive Cruise Control 251
- Door cylinder 15
- Door handle 15
- Door lock 15
- Door release lever 93
- Doors
 childproof locks 121
 opening and closing 15
- Downhill speed control 230
- Downhill speed control function 230
- Drawer 147
- Drink holders 148
- Drive Profile 271
- Driver
 see Correct sitting position 57, 58, 59
- Driver-side general instrument panel
 left-hand drive 9
 right-hand drive 10
- Driving
 driving abroad 137
 driving through water 236
 economical 233
 safe 56
 towing 85
- Driving abroad
 headlights 137
- Driving data 99
- Driving in winter
 trailer 296
- Driving mode 272
- Driving on flooded roads 236
- Driving profile 272
- DSG 224
- Duplicate keys 113
- Dust and pollen filter 158
- DVD
 DVD video mode 191
- Dynamic adjustment of headlight range 138
- E**
- Easy Connect 33
- Easy Open 116
 things to note 119
- EDL
 see Electronic differential lock 221
- Electrical accessories
 see Power socket 149
- Electric windows 18, 126
 convenience opening and closing 127
- Electromechanical steering 231
 lamp 231
- Electronic differential lock 221
- Electronic immobiliser 15
- Electronic self-locking 221
- Electronic Stability Control (ESC) 221
- Electronic torque management (XDS) 222

- Emergencies 78
 anti-puncture kit 78
 automatic gearbox emergency program . 230
 bulbs 46
 changing a wheel 48
 emergency towing of the vehicle 51
 fuses 45
 hazard warning lights 136
 jump leads 52
 manual unlocking and locking 80
 puncture 46
 replacing a blown fuse 46
 replacing the battery 320
 vehicle tool kit 78
 Emergency Assist 264
 see Emergency Assist 264
 switching off 264
 switching on 264
 Emergency braking assistance system
 indications on the display 247
 malfunction 249
 operating 249
 radar sensor 249
 switching off temporarily 250
 system limitations 250
 Emergency braking function 220
 Emergency braking warning 137
 Emergency operation
 front passenger door 16
 selector lever 38
 Emission control system
 control light 236
 Engine
 assisted starting 52
 noises 216
 running in 232
 Engine and ignition
 automatic ignition switch-off 214
 My Beat 217
 preheating the engine 216
 starting the engine 216
 starting the engine with Press & Drive 216
 stopping the engine 216
 Engine breakdown
 Control light 236
 Engine compartment 310, 313
 battery 44, 318
 brake fluid 43, 317
 coolant 42, 316
 engine oil 41, 315
 opening and closing 17, 311
 safety notes 310
 windscreen washer reservoir 43, 318
 Engine coolant 42
 control lamp 106
 G 12 plus-plus 42
 G 13 42
 specifications 42
 temperature display 106
 warning lamp 106
 Engine data 347
 Engine management 235
 control light 236
 Engine oil 41, 313
 changing 313, 315
 checking oil level 314
 consumption 314
 dipstick 314
 inspection service 313
 maintenance intervals 313
 specifications 313
 topping up 315
 Engine oil pressure
 control lamp 314
 Environment
 ecological driving 233
 environmental compatibility 232
 Environmental tips
 filling the tank 309
 refuelling 308
 Equipment 149, 307
 ESC
 electronic stability control (ESC) 221
 Multi-collision Brake 222
 Sport Mode 223
 Event Data Recorder 340
 Exiting a parking space with Park Assist 280
 Exterior lighting
 changing bulbs 89
 Exterior mirrors
 adjustment 20
 driving with a trailer 299
 Exterior rear-view mirrors
 adjusting the exterior rear-view mirrors .. 142
 exterior 142
 heated 142
 Exterior view 7, 8
 External aerial 307
F
 Fabrics: cleaning 337
 Fastening rings 153

- Fatigue detection 100
 Filling the tank 308
 Floor mats 61
 Fluid level control 41
 FM 182
 Four-wheel drive
 snow chains 237
 winter tyres 237
 Frequency band
 AM 182
 change 182
 DAB 182
 FM 182
 Front airbags 21, 70
 Front armrest 146
 Front Assist 221
 indications on the display 247
 Front passenger front airbag
 control lamp 73
 deactivation 22
 Front seats
 manual adjustment 19
 Fuel 41, 309
 consumption 344
 fuel gauge 105
 identification 309
 petrol 310
 refuelling 308
 saving 233
 Fuel consumption
 engine cut-off due to inertia 233
 Why does fuel consumption increase? ... 236
 Fuel gauge 105
 control lamp 105
 Fuel tank cap
 opening and closing 41
 Fuel tank flap
 opening and closing 41
 Full-LED Headlights 89
 Full Link 172
 pairing 175
 setup 175
 Function buttons 168
 Function Leaving Home 136
 Fuses 45, 85
 fuse box 86, 87
 identifying blown fuses 46
 identifying by colours 45
 preparation before replacing 46
 replacing 46
- G**
 Gear-change indicator 227
 Gearbox 38
 Gearbox DSG
 see Automatic gearbox 224
 Gear recommendation 227
 Gear shift paddles (automatic gearbox) ... 227
 General
 instrument panel 95
 General instrument panel
 control and warning lamps 36
 controls and displays 93
 engine compartment 313
 Glove compartment 148
- H**
 Handbrake
 lamp 218
 see Parking brake 219
 Hazard warning lights 31, 136
 HDC
 see Hill Descent Control 240
 Head-on collisions and their laws of physics . 64
 Head-protection airbags
 description 24
 safety instructions 71
 Headlights
 changing bulbs 89
 driving abroad 137
 headlight washers 140
 Head restraints 19
 adjustment 144
 front head restraints 60
 rear head restraints 61
 Headrests 19
 adjustment 144
 front 60
 Heated
 windscreen 162
 Heated rear window 40
 Hill Descent Control
 control lamp 240
 Horn 93
 How to jump start 52
 description 52
- I**
 Identification of the fuel 309

- Identifying letters on the engine
 - show 98
 - Ignition lock
 - see Starter button 30
 - Incorrect position 59
 - Indications on the display 98
 - adaptive cruise control 253
 - Drive Profile 271
 - Emergency braking assistance system (Front Assist) 247
 - identifying letters of the engine 97
 - odometer 97
 - selector lever positions 225
 - service intervals 106
 - traffic signs 102
 - tyre monitoring 327
 - warning and information messages 100
 - Indications on the screen
 - doors, bonnet and rear lid open 97
 - Outside temperature 97
 - positions of the selector lever 97
 - speed warning 97
 - Information profiles 95
 - Infotainment knobs 167
 - Infotainment system 33, 164
 - CD player 186
 - function buttons 168
 - general instructions for use 167
 - input mask 170
 - Jukebox (SSD) 189
 - memory card 187
 - on-screen keypad 170
 - safety instructions 164
 - text input 170
 - update navigation data 193
 - Wi-Fi Protected Setup (WPS) 181
 - Infotainment System
 - AUX-IN 188
 - Bluetooth® audio 188
 - changing the volume 168
 - DVD 191
 - general equipment panel 166
 - Images main menu 192
 - infotainment knobs 167
 - initial configuration 171
 - Internet access 181
 - memory buttons 183
 - mute 168
 - navigation 193
 - Radio mode 182
 - rotary knobs 167
 - scroll knob 169
 - scroll (display) 169
 - search in lists 169
 - sharing a WLAN connection 180
 - standby 167
 - station logos 183
 - switch on and off 167
 - Telephone mode 206
 - touchscreen 168
 - USB 187
 - Vehicle menu 205
 - verification boxes 168
 - WLAN 180
 - WLAN audio 190
 - Inspection 313, 331
 - Inspection service 313
 - Instrument panel 95
 - control and warning lamps 109
 - display 95
 - display indications 96
 - instructions shown on the screen 98
 - instruments 95
 - service interval indication 106
 - structure of the menus 98
 - use with the multifunction steering wheel 108
 - Instrument panel display 95, 96
 - Instruments 95
 - Interference from a mobile telephone 167
 - Interior lights 32
 - Interior view 14
 - ISOFIX 26, 28
 - ISOFIX system 26
 - ISOFIX System 28
- ## J
- Jack 48, 78
 - mounting points 49
 - Journey data display 99
 - Jukebox (SSD) 189
 - Jump leads 52
- ## K
- Key-operated switch 72
 - Keyless-Entry
 - see Keyless Access 116
 - Keyless-Exit
 - see Keyless Access 116
 - Keyless Access
 - Easy Open 116
 - Keyless-Entry 116

- Keyless-Exit 116
- Press & Drive 30, 214
- special characteristics 119
- starting the engine 216
- unlocking and locking the vehicle 116
- Keyless Access locking and ignition system
 - see Keyless Access 116
- Keys
 - assign key 113
 - car key 113
 - remote control 113
 - replacing the battery 120
 - spare key 113
 - synchronising 121
 - unlocking and locking 15, 114
- Kick-down
 - automatic gearbox 229
- Knee airbag
 - safety information 23
- L**
- Lane Assist 260
 - Control and warning lamp 260
- Lane Assist system
 - see Lane Assist 260
- Launch control (automatic gearbox) 229
- Leaving Home 136
- Lifting the vehicle 49
- Light
 - dynamic adjustment of headlight range .. 138
- Light Assist 134
- Lighting of the instrument panel 138
- Lights 30, 132
 - audible signals 132
 - AUTO 133
 - changing bulbs 89
 - coming home 135
 - control and warning lamps 132
 - daytime running lights 132
 - dipped beam headlight 132
 - fog light 135
 - hazard warning lights 31
 - interior lights 138
 - leaving home 136
 - light control 132
 - lighting of instruments 138
 - lighting of the controls 138
 - main beam lever 133
 - main beam lights 132
 - main beams 31
 - motorway light 137
 - parking lights 137
 - reading lights 138
 - side lights 132
 - switch 30
 - turn signal lever 133
- Load compartment in the luggage compartment
 - see Loading the luggage compartment ... 150
- Loading the luggage compartment 150
- Loading the vehicle
 - fastening rings 153
 - luggage compartment 16
 - roof carrier system 157
 - tailboard for transporting long items 152
 - trailer 303
- Locking and unlocking
 - in the door cylinder 15
 - Locking the front passenger door manually .. 16
- Luggage 150
 - Luggage compartment 16
 - automatic locking 126
 - electric opening and closing 124
 - luggage compartment lighting 138
 - luggage compartment variable floor 155
 - manual release mechanism 17
 - net bag 154
 - shelf 151
 - special characteristics of the electric rear lid 125
 - see also Loading the luggage compartment 150
 - Luggage compartment floor 155
 - Luggage compartment variable floor 155
 - Luggage net
 - luggage compartment 154
 - Lumbar support 143
- M**
- Main beam assist 134
- Main beam lever 133
- Main panel
 - turn signal and main beam lever 133
- Maintenance
 - see Service 331
- Maintenance intervals 313
- Malfunction
 - adaptive cruise control 252
 - clutch 230
 - emergency braking assistance system (Front Assist) 249
 - gearbox 231
 - towing bracket 302
- Manual release mechanism
 - rear lid 17

- Manual unlocking and locking 80
- Maximum trailer weight
loading the trailer 303
- Media
changing the Media source 186
main menu 184
messages and symbols 185
playback sources 186
playing modes 184
- MEDIA
copyright 184
- Media Control 179
data transmission and control functions .. 180
- Memory card 187
- Mirror 142
- MirrorLink 176
- Mobile 307
- Mobile Signal Amplifier 212
- Mobile telephones 307
- Motor
Start-Stop system 238
- Multi-collision Brake 222
- Multifunction display 99
- Multifunction steering wheel 110
- Multimedia 212
- My Beat 217
- N**
- Navigation 193
change view 198
entering the destination 195
importing vCards 201
main menu 194
messages and symbols 194
my destinations 196
- Navigation with images 202
- Offroad navigation 202
- points of interest (POI) 198
- predictive navigation 201
- route 196
- select the destination on the map 195
- split screen 199
- traffic reports (TRAFFIC) 200
- updating and installing navigation data ... 193
- Navigation system
CD-ROM player 148
- Net bag
luggage compartment 154
- Noises
adaptive cruise control 252
brakes 217
ESC 223
parking brake 220
tyres 50, 322
- Number of seats 62
- O**
- Octane rating (petrol) 310
- Odometer 95
total 95
trip recorder 95
- Offroad Navigation 202
- Oil change 315
- One-touch opening and closing
electric windows 128
- Opening 112
bonnet 17, 311
fuel tank flap 308
rear lid 124
sun blind (sunroof) 130
- sunroof 129
windows 126
- Opening and closing 15, 112
bonnet 17, 311
by remote control 114
fuel tank flap 308
in the door cylinder 15
rear lid 16
rear lid with electric opening and closing . 124
sunroof 129
windows 126
with the central locking switch 115
- Operating malfunction
Park Assist 273
sunroof 129
- Original Spare Parts 333
- Outside temperature
display 97
- Overview
of the structure of the menus 98
- P**
- Panoramic sliding sunroof
convenience opening and closing 127
see also Sunroof 128
- Park Assist 273
automatic braking intervention 281
automatic interruption 274
conditions for exiting a parking space ... 280
exiting a parking space (only for parallel spaces) 280
operating malfunction 273
parallel parking 278
parking conditions 278
perpendicular parking 278

- see Park Assist 273
 stopping prematurely 274
 Parking 220, 228
 with Park Assist 278
 Parking aid
 adjusting the display and audible warn-
 ings 285, 289
 automatic activation 284
 braking while manoeuvring 286
 driving with a trailer 286
 malfunction 286, 289
 rear parking aid 287
 sensors and camera: cleaning 336
 towing bracket 289
 visual indication 285, 288
 Parking aid system
 see Parking aid 281, 283, 287
 Parking assistance
 parking system plus 283
 see Park Assist 273
 surroundings warning 283
 Parking assistant (RCTA) 265, 270
 control lamp 266
 Parking brake 219
 activate 219
 automatic activation 220
 automatic release 219
 emergency braking function 220
 release 219
 Parking distance warning system
 see Parking aid 281, 283, 287
 Parking (automatic gearbox) 228
 ParkPilot
 see Parking aid 281, 283, 287
 Parts 307
 Passenger
 see Correct sitting position 57, 58, 59
 Passenger-side instrument panel
 left-hand drive 11
 right-hand drive 12
 Pedals 61
 Petrol
 Petrol 310
 Positioning seat belts
 during pregnancy 66
 seat belts 66
 Power 149
 Power management 234
 Power socket 149
 trailer 301
 Power steering
 see Electromechanical steering 231
 Preheating the engine 216
 Press & Drive
 starter button 30, 214
 starting the engine 216
 Products for vehicle maintenance 334
 Puncture
 action 46
R
 Racks 148
 Radar sensor 249, 253
 Radio
 changing frequencies 182
 main menu 182
 memorise station logos 183
 memory buttons 183
 RADIO
 information and icons 182
 Radio-operated remote control
 see Keys 113
 Radio DISPLAY: clean 337
 Radio transmitters 307
 Rain sensor 141
 control of the function 141
 Raising the vehicle 49
 RCTA 270
 see Parking assistant (RCTA) 265
 Rear
 headrests 61
 Rear-view mirror
 anti-dazzle 142
 interior anti-dazzle 142
 Rear Assist 294
 instructions for use 294
 parking 295
 screen 294
 special characteristics 295
 Rear Assist system 294
 Rear bulbs in the side panel
 disassemble the rear light 89
 Rear fog light
 control lamp 132
 Rear lid 16, 17
 see also Luggage compartment 124
 Rear lights in the rear lid
 disassemble the bulb holder 90
 Rear parking aid 287
 Rear seat backrest
 folding down 146
 folding down and lifting the backrest 146
 lifting 146
 Rear seat passengers
 see Correct sitting position 57, 58, 59

Index

- | | | | |
|--|---------|---|--------|
| Rear View Camera | 294 | Running in | |
| Refuel | | new brake pads | 217 |
| control lamp | 105 | new engine | 232 |
| fuel gauge | 105 | new tyres | 321 |
| refuelling | | S | |
| Petrol additives | 310 | Safe driving | 56 |
| Refuelling | | Safelock | 120 |
| opening fuel tank flap | 308 | see also Anti-theft security system | 112 |
| Remote control key | | Safety | |
| unlocking and locking | 114 | child safety | 73 |
| Removing and attaching head restraints | 144 | child seats | 73 |
| Repair work | 307 | deactivating the front passenger airbag ... | 22 |
| Replacement | | safe driving | 56 |
| parts | 307 | Safety equipment | 56 |
| Replacement parts | 307 | Safety information | |
| Replacing the battery | | knee airbags | 23 |
| of the vehicle key | 120 | Safety instructions | |
| Retaining hooks | 153 | belt tensioners | 67 |
| Retrofitting | | head-protection airbags | 71 |
| towing bracket | 305 | side airbags | 70 |
| Reverse gear (automatic gearbox) | 225 | use of seat belts | 63 |
| Revolution counter | 95, 105 | using child seats | 24, 74 |
| Rims | | Seat belt position | |
| changing a wheel | 48 | for pregnant women | 20 |
| Roll-back function | | seat belts | 20 |
| windows | 127 | Seat belts | 62 |
| Roof carrier | 156 | adjustment | 20, 65 |
| Roof carrier system | 156 | control lamp | 62 |
| Roof load | 157 | protective function | 63 |
| technical data | 157 | purpose | 62, 68 |
| Roof luggage rack | | safety instructions | 63 |
| attach the cross bars | 157 | unfastened | 64 |
| Roof rack | 156 | Seat belt tensioners | 20, 66 |
| Rotary knobs | 167 | Seat heating | 145 |
| | | Seats | |
| | | adjustment | 143 |
| | | electric seat | 19 |
| | | heating | 145 |
| | | rear seat backrest | 146 |
| | | Selective unlocking system | 114 |
| | | Selector lever lock | 226 |
| | | Selector lever (automatic gearbox) | |
| | | malfunction | 226 |
| | | manual release mechanism | 38 |
| | | positions | 225 |
| | | Service | |
| | | conditions of use | 332 |
| | | digital maintenance plan | 331 |
| | | fixed service | 331 |
| | | flexible service | 331 |
| | | oil change service | 331 |
| | | service | 331 |
| | | Service proof | 331 |
| | | services | 331 |
| | | servicing | 331 |
| | | sets of services | 333 |
| | | Service interval indicator | 98 |
| | | Service intervals | 106 |
| | | Service intervals display | 332 |
| | | Service Menu | |
| | | identifying letters on the engine | 98 |
| | | restart oil service | 98 |
| | | restart Trip | 98 |
| | | service interval indicator | 98 |
| | | time | 98 |
| | | Service Mobility | 333 |
| | | Service warning: check | 107 |
| | | Set | |
| | | time | 104 |

- Side airbags
 description 23
 safety instructions 70
- Signal lever 31
- Sliding panoramic sunroof 18
- Snow chains 50, 346
 four-wheel drive 237
- Spanner symbol 107
- Special characteristics
 area view system (Top View Camera) 292
 high-pressure cleaning devices 300
 tow-starting 81, 82
 towing 81
 trailer mode 304
- Special features
 Lowering the volume 167
- Speed limiter 243
 control lamp 243
 display indications 244
 operate 245
- Speed warning 99
- Sport Mode 223
- SSD
 see Jukebox (SSD) 189
- Stabilisation of the towing vehicle and trailer 305
- Start-Stop 238
- Start-Stop system
 operation 238
 switching off and on 240
 switch the engine off and on 238
- Start-Stop System
 driver instructions 238
 lamps 238
 the engine does not switch off 238
 the engine starts by itself 238
- Starter button 30, 214
- Starting the vehicle 30
- Steering
 control lamp 231
 electromechanical steering 231
- Steering wheel
 adjustment 21, 58
 gear shift paddles (automatic gearbox) ... 227
- Storage area
 front seat 147
 Storage compartments 147, 148
 glove compartment 148
 glove compartment lighting 138
- Storing objects
 trailer 296
- Sun blinds
 anti-trap function (sunroof) 131
 sunroof 130
- Sun protection 139
- Sunroof 128
 anti-trap function 131
 closing 129
 opening 129
 operating malfunction 129
 sun blind 130
- Sun visors 139
- Switch
 hazard warning lights 136
 Switch-off delay (Infotainment system) 167
- Switching off the lights 132
- Switching on the lights 132
- Switching the ignition on and off 30
- T**
- Tailboard for transporting long items 152
- Tail lights
 changing bulbs 89
- Technical data
 capacity 318
 roof load 157
 vertical load on the coupling 296
- Technical modifications 307
- Technical specifications 344
- Telephone
 Bluetooth® profiles 207
 call lists 211
 display and symbols 210
 enter telephone number 211
 general information 206
 main menu 209
 pairing a mobile phone 208
 places with special regulations 207
- Temperature display
 of the engine coolant 106
- Things to note
 towing 83
- Tightening torque of wheel bolts 346
- Time
 adjust 98
 set 104
- Tiptronic (automatic gearbox) 224, 227
- Top Tether 26, 29
- Top Tether system 26, 29
- Top View Camera 289
 see Top View Camera system 289
- Top View Camera system
 Instructions for use 291
 menus 292
 modes 292
 screen 291

Index

- Total traction 237
 - towing 82
- Tow-starting 52
- Tow-starting the engine 82
 - special characteristics 81
- Tow hitch
 - control lamp 300
 - electrical unlocking 299
- Towing
 - blind spot detector (BSD) 271
 - special characteristics 271
- Towing bracket 299
 - also see Trailer 299
 - control lamp 298
 - electrical unlocking tow hitch 299
 - fitting a bicycle rack 300
 - malfunction 302
 - retrofitting 305
- Towing the vehicle 51, 81, 82
 - driving tips 85
 - front towing eye 83
 - rear towing eye 84
 - special characteristics 81
 - things to note 83
 - total traction 82
 - tow bar 82
 - towing prohibited 82
 - tow rope 82
 - with the towing bracket 82
- Towline anchorages 51, 78
- Tow rope 298, 302
- Traffic Jam Assist 263
 - malfunctions 264
 - situations in which Traffic Jam Assist must be switched off 263
- Traffic sign detection system 102
 - indication on the display 102
 - limited operation 103
 - operation 102
 - speed warning 103
 - trailer 103
 - windscreen damage 104
- Traffic signs
 - indication on the display 102
- Trailer 296
 - adjusting the headlights 304
 - anti-theft alarm 302
 - anti-theft system 302
 - connecting 301
 - exterior mirrors 299
 - hooking up 301
 - loading 303
 - malfunction 302
 - maximum trailer weight 303
 - mode 304, 345
 - parking aid 286, 289
 - power socket 301
 - rear LED lights 298, 302
 - rear lights 298, 302
 - retrofitting a towing bracket 305
 - stabilisation of the towing vehicle and trailer 305
 - technical requirements 298
 - tow rope 298, 302
 - trailer mode 304
 - unlocking the electrical unlocking tow hitch 299
 - vertical load on the coupling 296, 303
- Trailer mode
 - also see towing bracket 296
 - see Driving with a trailer 296
- Trailer weight 345
- Transporting children 73
- Transporting items
 - fastening rings 153
 - roof carrier 156
 - roof carrier system 156
- Transporting objects
 - loading the trailer 303
 - net bag 154
 - retaining hooks 153
 - roof carrier system 157
 - tailboard for transporting long items 152
 - trailer mode 304
- Trip odometer 98
- Turn signal convenience function 133
- Turn signal lever 133
- Tyre Mobility Set 47
 - components 79
 - inflating a tyre 79
 - sealing a tyre 79
- Tyre Mobility System
 - see Anti-puncture kit 78
- Tyre monitoring system 325
 - tyre monitoring indicator 327
- Tyre pressure 322, 345
- Tyre profile 323
- Tyre repair 78
- Tyre repair kit 78
 - see also Anti-puncture kit 78
- Tyres 321
 - accessories 322
 - changing 48

- dimensions 324
 - interchanging 324
 - new tyres 324
 - repair kit 78
 - service life 322
 - tyre pressure 322
 - wear indicators 323
 - with compulsory direction of rotation 50
 - with directional tread pattern 322
 - Tyre tread depth 323
 - Tyre wear 323
- U**
- Unfastening your seat belt 65
 - Unfasten the seat belt 20
 - Unlocking and locking 15
 - by remote control 114
 - with Keyless Access 116
 - with the central locking switch 115
 - USB 212
 - connecting an external data storage device 187
 - USB/AUX-IN Port 212
- V**
- Vanity mirror 139
 - Vehicle 344
 - data label 344
 - identification data 344
 - identification number 344
 - raising 49
 - unlocking and locking the vehicle with Keyless Access 116
 - vehicle identification number 344
 - Vehicle battery 44, 318
 - assisted starting 52
 - charge level 234
 - charging 320
 - connecting and disconnecting 318
 - disconnect and connect 107
 - power management 234
 - replacing 320
 - winter conditions 318
 - Vehicle care 318
 - windscreen wipers service position 54
 - Vehicle interior monitoring and anti-tow system 123
 - activation 122
 - Vehicle maintenance 334
 - Vehicle paint 336
 - maintenance 336
 - Vehicle seats 62
 - Vehicle tool kit 48, 78
 - Ventilation slits 151
 - Vertical load on the coupling 296
 - Vertical load on the trailer coupling 303
 - loading the trailer 303
 - Warning lamps 106
 - engine coolant 106
 - Warning symbols 109
 - see Control and warning lamps 109
 - Warning triangle 136
 - Warranty 334
 - Washing the vehicle 334
 - external vehicle maintenance 334
 - high pressure cleaners 334
 - sensors 273
 - things to note 119
 - Weights 345
 - What negatively affects driving safety? 56
 - Wheel balance 322
 - Wheel bolts 346
 - anti-theft 48
 - caps 48
 - loosening 49
 - tightening torque 325
 - Wheels 321, 345
 - chains 346
 - changing 48, 50
 - new wheels 324
 - snow chains 50
 - temporary spare wheel 328
 - Wheel spanner 78
 - Wheel trim 48
 - removing 48
 - Windows 18, 126
 - electric 18, 126
 - Window wiper 139
 - Window wiper blade 32
 - windscreen and rear window wiper blades 54
 - changing 54
 - cleaning 54
 - Windscreen and rear window wiper blades 81
 - Windscreen heating 162
 - Windscreen washer 43, 139
 - Windscreen washer water 318
 - capacity 318
 - checking 318
 - topping up 318

Windscreen wiper and rear window wiper systems	
service position	54
Windscreen wipers	32, 139
cleaning	336
functions	140
headlight washer system	140
heated windscreen washer jets	140
lifting the wiper blade	54
rain sensor	141
replacing the wiper blades	54
service position	54
special characteristics	140
window wiper lever	139
Winter conditions	
battery	318
snow chains	50
tyres	329
Winter driving	
sunroof	129
Winter operation	
headlight washers	140
heated windscreen washer jets	140
salt on the roads	141
Winter tyres	329
four-wheel drive	237
Wireless Charger	212
WLAN	180
connecting an external audio source	190

X

XDS	222
-----------	-----

SEAT S.A. is permanently concerned about continuous development of its types and models. For this reason we ask you to understand, that at any given time, changes regarding shape, equipment and technique may take place on the car delivered. For this reason no right at all may derive based on the data, drawings and descriptions in this current handbook.

All texts, illustrations and standards in this handbook are based on the status of information at the time of printing. Except for error or omission, the information included in the current handbook is valid as of the date of closing print.

Re-printing, copying or translating, whether total or partial is not allowed unless SEAT allows it in written form.

SEAT reserves all rights in accordance with the "Copyright" Act.

All rights on changes are reserved.



This paper has been manufactured using bleached non-chlorine cellulose.

© SEAT S.A. - Reprint: 15.09.18

Inglés 575012720BF (09.18)



575012720BF

